

Surveyors Operations Manual



This page intentionally left blank.

Part A

Introductions and Content



**Introduction to the Surveyors Operations
Manual by the Reviewing committee.
Content**

**Foreword notes by the President's of the
Surveyors Board of Queensland; the
Director-General's - Department of Natural
Resources and the Department of Mines and
Energy respectively.**

**© Copyright 1995
Surveyors Board of Queensland**

This work is copyright. Apart from any use as permitted under the Copyright Act 1968, no part may be reproduced by any process without written permission from the Surveyors Board of Queensland.

GENERAL

The amendments to these Guidelines are made by replacement of the applicable page(s). Each amendment page when issued is identified by a revision number and an updated copy of the Revision Log Page will indicate all the amendments.

These Guidelines cancel and replace the previous 1992 Edition of the Board Operations Manual and amendments issued in July, 1993, April, 1994 and September, 1995.

The Manual has been renamed the Surveyors Operations Manual from January, 1996. This reflects the substantive input into the Manual on Guidelines from the Department of Natural Resources and the Department of Mines and Energy.

UPDATE No. 8 WARNING - June 1998

As a result of the replacement of Part E3 of the Manual, that is the Survey Requirements of the Department of Natural Resources, complete cross referencing between Part E3 and Part E2 - Guidelines for Preparation of Survey Plans, has not been finalised at the time of printing.

Users of the Manual should contact the District Surveyor at the local DNR Service Centre, for clarification of any matters of conflict between Part E3 and Part E2.

IMPORTANT NOTE

Information is provided as a guide for practitioners in Queensland and readers should adapt the information supplied to suit the circumstances of any particular project, locality or client, etc. The information should not be taken as a substitute for detailed professional advice from other disciplines where information from other disciplines forms part of the information provided in the Surveyors Operations Manual.

Should a conflict arise between these Guidelines and various Acts and Regulations referred to, then the provisions of those Acts and Regulations will prevail. The Guidelines shall not be taken as a substitute for detailed professional advice.

Published by : The Surveyors Board of Queensland, under Regulation 5 of the Surveyors Regulation 1992.

**P.O. Box 810
Spring Hill Qld 4004
Phone : (07) 3839 7744
Fax: (07) 3839-3841
Internet: www.qld-som.com.au
Email: survbrdq@ozemail.com.au**

Introduction

The Board Operations Manual (BOM) was released in November 1992. The name of the manual was changed to the Surveyors Operation Manual (S.O.M.) in January, 1996.

Revision 8 (June, 1998) is the final hard copy review of the Manual. The SOM was placed on the Internet at www.qld-som.com.au, from 1 July, 1998.

Copies of the SOM will continue to be available for purchase from the Board at P.O. Box 810, Spring Hill, Qld 4004. Phone: (07) 3839 7744.

Surveyors Operations Manual Committee
June, 1999

Internet Format

DOWNLOADING THE SOM FROM THE WEB PAGE

A number of enquiries have been received from persons concerned that they have been unable to download the entire Manual from the Web Site.

This is not surprising! The SOM is live on the Web.

That is to say, it is on the internet in Hyper Text Markup Language. **HTML.** It is not possible to put the manual on the Web as a Word document.

None-the-less you can download the entire document in its current html format. Where people will experience difficulty is that **the SOM on disk is approximately 180 Mega Bytes in size** when you take into account all of the text and the example survey plans.

It would take you for ever to download the entire document, and unless you have a permanent connection, most Internet Service Providers (ISPs) will disconnect you long before that.

Besides, you would then have to totally reformat the document into Word format and add all the page numbers, etc before printing it. **Printing will take approximately a ream of paper (nearly 500 sheets) printed double sided.**

The Board recommends that each office of your survey practice has at least one hard copy of the SOM obtained from the Board. Most of you already have this.

You can then download the updates from the Web Site (Yes, the Updates will be in Word 6 format), print them out and update your hard copy.

If you need a copy of an example survey plan, you would get a better quality copy by photocopying it out of the printed SOM.

Updates

The SOM has a 'front end' attached to it, which shows the actions taken on the SOM on various dates and Board notices.

It would be prudent to check the SOM's notices pages once a week. This will then keep you up to-date with the most recent information.

To enable you to keep your hard copy of the SOM updated, when a complete page is being replaced, or new information issued, these pages are set up in Word 6, and as such can be printed.

HARD COPY

If you wish to subscribe to the Board's hard copy service, a subscription form is posted with the Registration renewal in October each year.

Contents

Part A **Introductions and Content**

Part B **Policies and Information**

Part B1 - Policy Statements and Memoranda

Statements of Policy adopted by the Surveyors Board of Queensland from time to time, and Memoranda to Registered Persons.

Part B2 - Historical, General and Technical Information

Information on a range of matters, of both a historical, general and survey related nature.

Part C **Registration Requirements**

Part C1 - Registration of Individuals

Requirements, Directions and Guidelines for Registration of Surveying Associates, Surveying Graduates and Surveyors and the Endorsement of Licensed and Consulting Surveyors, and Reciprocity.

Part C2 - Registration of Bodies Corporate

Requirements, Directions and Guidelines for Registration of bodies corporate as Surveyors and the Endorsement of registered bodies corporate as Licensed and Consulting Surveyors.

Part C3 - Renewal of Registration

Part D **Education, Training and Practical Experience**

Part D1 - Professional Training Agreements and Graduate Diploma in Surveying Practice

Alternatives for obtaining the required practical experience for Registration, including Professional Training Agreements and the Survey Practice Course.

Part D2 - Specifications for Professional Assessment Projects and Guidelines for Examiners

Specifications for the Professional Assessment Project (PAP) which candidates for registration submit to the Board as evidence of professionalism, and Guidelines for Examiners.

Part E

Standards for Surveys

Part E1 - Directions and Recommended Practices

Directions and Recommended Practices under the *Surveyors Act 1977* to assist surveyors in the performance of their work.

Part E2 - Survey Plan Guidelines

Outlining the recommended drafting practices which the Surveyors Board considers will satisfy the requirements of the Registering Authorities -- covers both Department of Natural Resources and Department of Mines and Energy survey plans.

Part E3 - Department of Natural Resources, Survey Requirements and Directions for the Preparation of Plans

Outlining the survey and drafting practices for survey plans as required by the Department of Natural Resources.

Part E4 - Department of Mines and Energy, Survey Plan Requirements

Outlining the survey and drafting practices for survey plans as required by the Department of Mines and Energy.

Part E5 - Department of Main Roads

Outlining requirements for Engineering surveys on State Controlled Roads.

Part F

Disciplinary Procedures

Part F1 - Complaints Procedure

How a complaint must be lodged, how it is assessed and dealt with, and guidelines on information required for a complaint by one surveyor against another surveyor.

Part F2 - Investigation and Finalisation

Gathering of information, evidence and how a complaint may be progressed. Counselling and re-education under the Board's guidance, arbitration, "second tier" procedures and the Surveyors Disciplinary Committee. Publication of the outcome.

Part G

Surveyors Board Forms

Specimen copies of all forms used by the Surveyors Board and approved by the Board under the Surveyors Regulation 1992.

Parts H - X

Reserved for future use

Part Y

Surveyors Act

Use this Part to file your updated copy of the Surveyors Act obtained from the Government Printer - GOPRINT

Part Z

Surveyors Regulation

Use this Part to file your copy of the Surveyors Regulation obtained from the Government Printer - GOPRINT



Dear Colleague,

The Surveyors Operations Manual is published by the Board, on behalf of the contributors to the Manual, the Department of Natural Resources, the Department of Mines and Energy and the Board.

The Board issues the Manual under Section 5 of the Surveyors Regulation 1992. The Manual is considered to be a primary reference document for surveyors and the surveying profession.

The Manual is a dynamic document and as surveying and associated technology continues to develop, the Manual will endeavour to reflect those changes and developments. The manual reflects current best practice but surveyors are always at liberty to use their discretion. Alternative approaches that achieve a similar outcome are encouraged but surveyors must be prepared to document any alternatives used.

R B RALSTON
PRESIDENT

May, 1999

The Surveyors Board of Queensland - PO Box 810, Spring Hill QLD 4004



2 April 1996

**DEPARTMENT
OF LANDS****Office:****Director-General
Level 9****Department of Lands
Cnr Main & Vulture Sts
WOOLLOONGABBA****Postal :****Locked Bag 40****COORPAROO
DELIVERY CENTRE
Q 4151****The President
Surveyors Board of Queensland
PO Box 477
WOOLLOONGABBA QLD 4102**

Dear Sir

The Survey Requirements of the Department of Natural Resources is a compendium of requirements, based on the legislation, policy and procedures affecting cadastral surveys in Queensland.

The document distinguishes between mandatory requirements, usually based on legislation and departmental policy, from those other provisions which provide guidance subject to the professional judgement of surveyors.

It has been prepared to provide cadastral surveyors with a guide to the requirements of the Department of Natural Resources in its role as a survey plan registering authority in Queensland.

I commend the document to you.

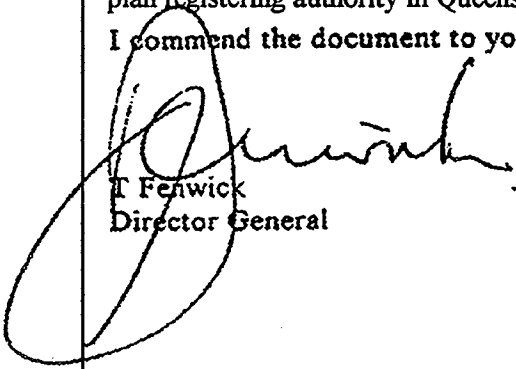
Contact:**Mr T Fenwick
Director-General****Phone:****(07) 896 3366****Fax:****(07) 896 3697**
**T Fenwick
Director General**

**DEPARTMENT OF MINERALS AND ENERGY**

OUR REF.

YOUR REF.

Queensland Minerals & Energy Centre, 61 Mary Street, Brisbane QLD 4000
G.P.O. Box 194, Brisbane QLD 4001

20 January 1998

The President
Surveyors Board of Queensland
PO Box 810
SPRING HILL QLD 4004

Dear Sir

The *Surveyors Operations Manual* plays an important role in communicating to surveyors the needs of the mining industry in the survey of mining tenure boundaries, pipeline licences and other surveys, as well as the Department of Mines and Energy's requirements for plan registration.

This Department depends on surveyors to provide secure tenure for mining titles. The contents of the Department's contribution to the *Manual* are based on past experience and are upgraded to reflect changes in technology and techniques.

Community expectations today demand changes in the law more frequently than in the past. It is incumbent on members of the professions to refresh and extend their knowledge of the needs of the industries they work with and of the laws, regulations and policies that help meet these needs.

Placing this latest revision on the Internet will improve access to the information and to changes to it. I support the endeavours of the Surveyors Board in keeping the *Manual* up to date and in finding more effective ways to distribute it to the survey profession.

Yours faithfully

DR R W DAY
Director General



Part B

Policies and Information

B1

Statements of Policy adopted by the
Surveyors Board of Queensland from time
to time and Memoranda to Registered
Persons

B2

Historical, General and Technical
Information

Directions and Recommended
practices are set out at
Section E.



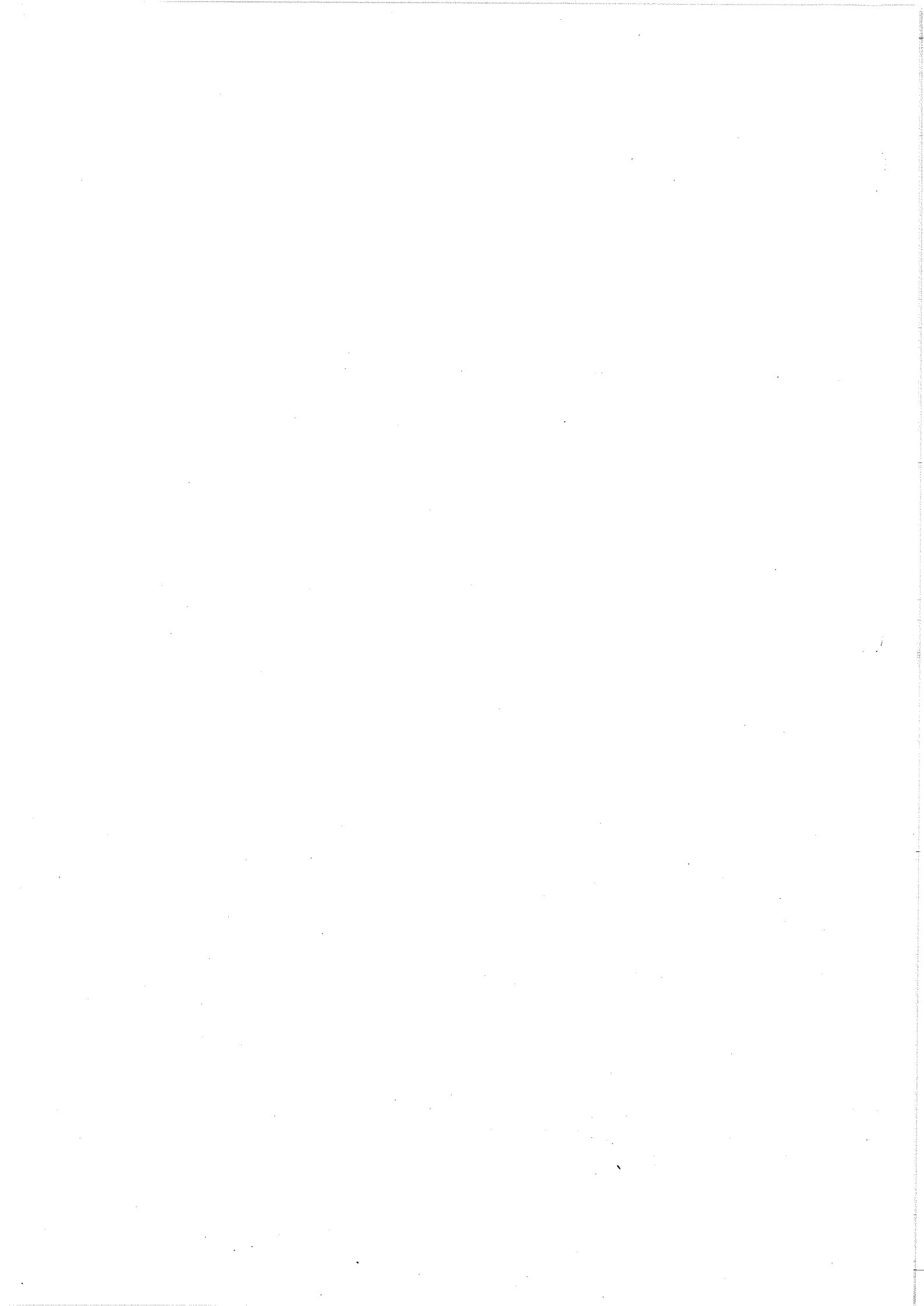

Introduction

The Surveying Profession, through its various representative bodies, provides both general and technical information, as a resource for surveyors. The information includes criteria, opinions, procedures and practices, to assist the professional surveyor in making considered judgements on surveys and associated surveying advice.

It is the responsibility of the surveyor, to address each survey instruction with diligence and care. The specific circumstances are paramount and must be addressed generally and specifically. The information provided is but one source, it may not be complete or be relevant to each circumstance. The professional and competent surveyor would carry out adequate research to satisfy themselves on the particular matter being addressed by them, prior to giving their advice.

Index Part B1

Item	Section	Page
Policies		
Mission and Objectives- Board	1.0	B1--3

Memoranda

Professional Behaviour by Registered Person	3/93	B1--4
Supervision	6/93	B1--5
Identification Surveys	8/93	B1--7
Responsibilities of the Licensed Consulting Surveyor	1/97	B1--8
Guidance to Surveyors in relation to Survey Infrastructure	2/97	B1--9
Survey and Plan Requirements	4/97	B1--11
Cadastral Survey Plans	5/97	B1--12

Part B2

General Information

Historical Marking	1.0	B2--1
Pointer Peg	1.1	B2--1
Reference Tree	1.2	B2--1
Survey Post	1.3	B2--2
Lockspits	1.4	B2--2
Line Pegs	1.5	B2--3
Fence Traverses - Grazing Farms	1.6	B2--3
Qld Legislation Affecting Surveyors	3.0	B2--5
Convert Bearing from CAM to AGM	4.0	B2--7

Technical Information

High Water Mark -Determination of	1.0	B2--9
Alternative Survey Methods	2.0	B2--12
Easement Surveys	3.0	B2--12
Unmarked Corners and Boundaries	4.0	B2--14
Unsurveyed Railway Boundaries	5.0	B2--14
Resumption Boundaries	6.0	B2--15
Cadastral Surveys Using GPS	7.0	B2--15
Table of the Counties of Qld	Table 1	Page 1

This page intentionally left blank.

Policies

1.0 Surveyors Board of Queensland - Corporate Objectives 1998 - 2001

Mission of the Board

The Board aims to ensure public confidence in surveying.

Objectives of the Board

EDUCATION To accredit educational and training programs to achieve appropriate levels of academic standard and professional competence in surveying.

REGISTRATION To implement a registration model that recognises the status of responsibilities of surveyors as well as multi-skilling and staged career path development.

STANDARDS To establish and monitor surveying standards which comply with national standards and which are directed toward assuring accountability to and protection for the public.

DISCIPLINE To implement effective investigatory and disciplinary procedures dealing with breaches of the Surveyors Act.

CONDUCT AND PROFESSIONALISM To review and adopt Codes of Conduct and Professional Standards to meet community expectations.

MEDIATION AND ARBITRATION To develop mediation and arbitration processes with the profession, to resolve disputes impacting on the community.

GOVERNMENT LEGISLATION To administer legislation and provide proactive advice to government on existing and proposed legislation relevant to surveyors and the community.

RESOURCES To obtain funding which reflects the beneficiaries of the Board's activities.

(In all the Board's functions, cognisance would at all times be given to equal opportunity.)

March, 1999

Memoranda

Memorandum No 3/93

SUBJECT:
Professional Behaviour By Registered Persons.

The Board continues to deal with Registered persons, who fail to maintain even the basic standards expected of professional and competent surveyors. There is a demonstrated lack of professionalism displayed by a minority of practising surveyors, some with long standing experience. While these surveyors represent only a very small part of the profession, their performance is reflecting poorly on the profession as a whole.

The Board has resolved that it will move with firmness and determination in all cases of undesirable or unprofessional conduct brought to its attention. Matters of concern include:

- (i) standard of survey work carried out in the field and the supervision thereof
- (ii) staffing and conduct of branch offices (often managed by unqualified personnel)
- (iii) non compliance with the provisions of the Surveyors Act and Regulation, with particular reference to the lodgement of plans for registration without the survey having been completed
- (iv) the practice of not lodging copies of Identification Surveys, see also Memorandum No. 8/93.
- (v) an apparent lack of professional responsibility demonstrated by some surveyors appointed as examiners and assistant examiners for Professional Assessment Projects
- (vi) the non performance with respect to client requests and instructions.
- (vii) other matters that come to the attention of the Board from time to time.

The Board wishes to remind Surveyors that the continuation of the registration system depends largely on its being able to continually demonstrate that a high level of competency exists amongst registered persons. The continued support of all Surveyors is necessary to identify and address examples of unprofessional behaviour.

March, 1993.

Memorandum No 6/93

SUBJECT: Supervision

A number of complaints against Surveyors received by the Surveyors Board can be traced to a lack of adequate supervision by the Registered person responsible for a survey performed by other technical staff. The Board, when carrying out its investigations, has discovered a wide range of interpretations by surveyors as to what was required in the Surveyors Regulation 1992, Part 3 and specifically Section 18, 'Performance of Surveyors'.

Supervising Surveyors should also note the requirements of Section 20 'Placement of survey marks', in the Surveyors Regulation 1992.

The Board considers that the interests of the public must be protected and that the supervising surveyor must fulfil his professional responsibilities when supervising others.

The Surveyors Regulation 1992, has clarified what was stated in the 1978 Regulations and the surveyor shall continue to:-

- "(a) ensure that the survey is performed in accordance with the regulation and to the standard of accuracy prescribed;
- (b) ensure that any part of a survey that is not performed by the Surveyor personally is performed by persons for whose work the Surveyor accepts responsibility;
- (c) ensure that the survey is carried out under the immediate personal supervision of a Surveyor who shall attend in the field to the extent necessary to give effective supervision to the carrying out of the survey in accordance with the Regulation and any relevant Directions to Surveyors issued by the Board".

In considering an appropriate definition for the nature and extent of supervision, the Board was mindful of two recent findings. The first emerged out of a disciplinary hearing in Queensland presided over by Judge Morley in August, 1991.

In considering the nature of professional services offered to the public, Judge Morley commented that skills and professional services offered by surveyors are personal and that "the surveyor's vocation is a profession. The Surveyor's professional services are not business or trade services which are able to be performed by representatives, agents or employees."

The second relevant case involved the character and extent of supervision by a Surveyor, brought into question during an appeal hearing in the District Court of NSW against a decision by the Surveyors Board of NSW.

The appellant submitted that in relying upon the considered knowledge and experience of a person who was not a registered surveyor, he was taking reasonable precautions to verify the accuracy of a survey. He further submitted that he (the appellant) did not need to attend upon the land and did not need to give personal supervision to the field work. It was submitted that he was entitled to rely upon un-supervised field work in drawing the plan and certifying as to the accuracy of the survey.

These submissions were rejected by the presiding judge.

As part of the judgement it was stated that "...where a survey is not made by the surveyor himself, but is made under the supervision of a surveyor, Regulation 7 (of the NSW Act) fairly and squarely imposes upon the surveyor a requirement to personally attend on the land ("the ground") to be surveyed and to personally supervise ("exercise...immediate oversight and personal direction") the survey of that land. I cannot see how a surveyor could meet the requirements of Regulation 7 without attending on the land and supervising the survey of that land. I cannot see how a surveyor, if he or she did not make the survey himself or herself, could certify as to the accuracy of the survey without attending on the land and supervising the survey of that land".

Neild J.R. went on to say that he was satisfied that the appellant (a) failed to attend on the land; (b) failed to supervise the field work and that these departures plus others, constituted misconduct in a professional respect.

The Surveyors Regulation 1992, provides for a definition of 'supervision' and at Section 18 the regulatory requirement. This now implements the policy developed by the Board and circulated to registered persons in September, 1991. The policy is reprinted hereunder.

SUPERVISION

"Supervision means the immediate personal oversight by the responsible surveyor of the planning and execution of all surveys, including the method of measurement and placement of survey marks, the preparation of the plan of survey and, in the case of a cadastral survey, the examination of evidence of the limits of ownership relied on in the fixation of existing boundaries."

March, 1993

Memorandum No 8/93

SUBJECT: Identification Surveys

Under the Surveyors Regulation 1992, a Licensed Surveyor, when carrying out a survey for the purpose of identifying or remarking boundaries of land (Section 26), is required to prepare a 'plan' and forward a copy of such plan to the Registering Authority within sixty days after the completion of the survey (Section 30).

Identification Survey plans must be endorsed with the standard Form 13 Certificate and signed by the Licensed Surveyor.

Despite amendments made to the Survey Plan Guidelines in 1992 to reflect this, the Board is finding increasing evidence that the Form 13 Certificate is not being used for Identification Surveys in many instances. Surveyors should ensure that all Identification Survey Plans are endorsed with the correct certificate. The Board is further concerned that in some instances, accepted professional standards with respect to reinstatement, marking and plan presentation, are not being maintained by some Licensed Surveyors.

The Board continues to note an increase in reports, that plans of surveys effected under the Surveyors Regulation 1992 are not being deposited in accordance with the requirements of Section 30.

The Board has resolved to investigate these reports and to pursue disciplinary action against any Surveyor who has not complied.

June, 1993

Memorandum No 1/97

SUBJECT:

Responsibilities of the Licensed Consulting Surveyor

The Board is aware that "Surveyors" who do not hold either Registration and/or Endorsements, may be utilising Registered surveyors with the Licensing and Consulting endorsements, to provide signatures to plans and/or documents prepared by unregistered persons.

A Consulting endorsement must be held by a Registered Surveyor, together with Public Liability and Professional Indemnity insurances, where the registered surveyor provides survey advice to the public, either directly or indirectly, for a fee. That is, a self-employed registered surveyor who subcontracts to another Consulting Surveyor, must hold the consulting endorsement and associated insurances, in his/her own name.

The Licensing endorsement allows the registered surveyor to carry out cadastral survey work. It requires that licensed registered surveyor to be involved in the cadastral surveys, from taking the client instruction, providing appropriate work briefs to other registered persons and where necessary attending in the field and carrying out relevant checking procedures. Adequate supervision must be evident. The survey plan, when signed by the licensed surveyor, becomes the responsibility of the signing surveyor.

It appears that some Registered Surveyors have not understood their responsibilities under both the Licensing and the Consulting endorsements. The Registered Licensed surveyor must have an appropriate involvement in each cadastral survey on which he/she signs a plan or document. Without specific and direct involvement in the survey that person should not sign the plan. Licensed Surveyors should not entertain the notion of providing his/her name and signature to another person who carries out cadastral survey work and is either not registered with the Board or is not qualified and as such, not entitled to carry out cadastral survey work.

The Queensland Board, where it becomes aware of occurrences of this nature, will not hesitate to take disciplinary action against a Registered/Licensed Surveyor involved in such activities. There have been several recent cases in other States where a surveyor has simply signed a cadastral plan without any involvement in the survey. Disciplinary action was taken and penalties were imposed.

January, 1997

Memorandum No 2/97

SUBJECT:

Guidance to Surveyors in Relation to Survey Infrastructure

This memorandum should be considered as a consolidation and replacement of Memorandum 7/93 "Guidance to surveyors for the Establishment of and Connection to a Coordinated Survey Framework" and Memorandum 1/96 "Guidance to Surveyors in Relation to Survey Infrastructure". These memoranda recognised the need for a more integrated approach to surveys given the increased reliance by many organisations on survey data in GIS applications.

The previous memoranda reflected the legislative environment at the time. A proposal to change existing legislation is now progressing and the Government plans to have legislation in relation to Survey Infrastructure ready by the end of 1997.

In the interim, the Board continues to support Survey Infrastructure initiatives which deal with practical survey issues such as connections to Permanent Survey Marks and reference to AMG and the AHD.

Since the publication of Memoranda, the Department of Natural Resources (DNR) continues progress on establishment of Queensland's geodetic network and on making survey control information more easily accessible.

From a state wide perspective, the 100 km GPS network was completed in the 1996/97 financial year. The 100 km GPS network has been included in the national adjustment to produce GDA94 which forms the fundamental data set for the move to a geocentric datum by the year 2000 and establishes a strong framework for more local geodetic networks. Significant progress has been made in the establishment of 3-5 km GPS networks in many urban areas throughout the state. Considerable work by many organisations, including Local Government and private survey firms, has contributed to increasing the density of the network providing a consistent reference frame for local surveys.

In relation to access to information, the Basic Land Information Network project within DNR now enables efficient, on demand production of key maps of survey control. Coordinate and height information and the corresponding images are now available on line for any PSM at any DNR service centre.

In relation to technical standards, the Board continues to support the desirability of adopting national approaches such as those promoted by the ICSM. ICSM continues to revise and update its "Standards and Practices for Control Surveys" (Special Publication 1). During 1996, ICSM also released "Best Practice Guidelines on the Use of GPS for Surveying Applications".

It is intended that these guidelines will be supplemented with local content and released as part of a future update to the SOM in early 1998. The Board supports the principles of the ICSM Best Practice Guidelines when undertaking cadastral surveys using GPS, including the need to connect to existing control to facilitate the traceability of the GPS measurements.

The Board supports a DNR proposal to develop a section of the SOM to pull together and further document technical standards in relation to Survey Integration once the relevant legislation is in place. In the interim, the Board continues to support the requirements stated previously.

That is, where a PSM is to be coordinated, it should be done by a closed connection, to Class C standard (as per the ICSM publication) to at least two stations on the existing State control network. Where cadastral surveys are conducted using GPS techniques in accordance with the Surveyors Regulation, 1992, Section 29 (1), connection to the State Control Network is mandatory where existing control is within 50 km.

Modern technology should in no way compromise the traditional professional and ethical values that are fundamental to good survey practice. Independent self check, closure and calibration etc., still need to be a consideration, despite the techniques adopted.

With respect to surveys in areas lacking survey control, the Board encourages the profession to undertake the establishment of a network of Permanent Survey Marks (preferably coordinated) to facilitate the introduction of survey integration and underwrite the best utilisation of Geographic Information Systems.

The Board continues to strongly support the November 1996 amendments to the Survey Requirements of the DNR which change the status of two important sections relating to Survey Integration from advisory to mandatory. These sections deal with *Meridian* and *Permanent Survey Marks*.

The requirement for connection to PSMs on larger surveys furthers the concept of "integratable surveys" whereby cadastrally connected PSMs can be coordinated using GPS techniques, which are now highly efficient. Such an approach allows surveys to be brought into and maintained in a common reference frame (presently realised by AMG and the AHD).

Given the increasingly important role played by local government and other significant users of information systems based on survey data, the Board intends to work with such organisations and the registering authorities to continue to progress the Survey Infrastructure initiative.

June, 1997

Memorandum No 4/97

SUBJECT: Survey and Plan Requirements

The Board wishes to remind Registered Persons on various survey matters and preparation of plans, with which the Surveyor must comply. The relevant Statutes set the legal parameters, however, the Surveyor must also comply with the requirements of the Board, the Registering Authorities and with what is normally termed as 'established practice'.

The Surveyors Operations Manual is the record of notifications to registered persons, of the various survey and plan requirements. The survey requirements are issued under Section 5 of the Surveyors Regulation 1992.

In considering the various survey and plan requirements, Surveyors should note the statement by Judge Morley Q.C. in June 1997 resulting from a Surveyors Disciplinary Committee hearing.

"The submissions and evidence received during this hearing raised what are and what were during 1996 those requirements which bound any practising surveyor in this State drawing and engrossing a plan of any completed cadastral survey of any land in this State when the plan is intended to be lodged only for survey record purposes. First, it is the duty of any such surveyor licensed under this State's laws to prepare and deposit a plan of any completed cadastral survey, and that duty lies upon the surveyor who completed the survey upon the surveyor who supervised, and the surveyor who has delegated the supervision to another who supervised the survey⁴⁴. Second, it is the manifest legislative intent evidenced by a number of the State's statutes read together, that every plan required to be or to be lodged must be of an accurate survey of land in this State, must be accurate evidence of and in respect of that survey, and must be such that it is able to contribute accurate evidence of the survey to which it refers to an accurate, comprehensive, and useable land register⁴⁵ or to a survey of high precision for the purpose of establishing permanent marks and enabling co-ordination of surveying throughout this State⁴⁶. Third, there are a number of specific measures both statutory and with statutory authority which define specific requirements for certain survey plans⁴⁷."

44 Surveyors Regulations 1992 (Q) r 30.

45 Land Act 1994 (Q) ss 278 et seq, where ss 280, 335, 352, and 356 have direct relevance to surveys and plans of surveys; and Land Title 1994 (Q) ss 28 et seq, where ss 29(2), 30, 65(2), 83A have direct relevance to surveys and plans of surveys.

46 Survey Co-Ordination Act 1952 (Q) ss 8, 9.

47 For examples, the Surveyors Regulation (Q) r 18-33; Land Title Regulation 1994 (Q) r 4(2); Land Act 1994 (Q) ss 352, 364; Land Title Act 1994 (Q) s 50, 83A, 95, 155(1); 165; and the Surveyors Act 1977 (Q) s 52.

September, 1997

Memorandum No 5/97

SUBJECT: Cadastral Survey Plans

The Board has noted on a number of occasions in 1997, that there continues to be a belief by some Licensed Surveyors that there are differing standards for cadastral surveys, dependent upon the type of plan on which the survey information is depicted or where the survey is located.

The June 1997 Surveyors Disciplinary Committee hearing, was provided with evidence that some surveyors have different standards for urban, rural and identification surveys. The Disciplinary Committee did not accept that the survey standards were different.

Judge Morley Q.C., in his reasons, said in part, "... does not heed the relatively recent statutory enactments⁴⁹ positively requiring that all cadastral surveys within this State be recorded accurately upon a plan which must be lodged in support of accurate and complete land registers and survey coordination measures."

A boundary survey is a cadastral survey, and must meet the requirements set out in the *Surveyors Regulation 1992*, and the various Directions, Recommended Practices and other Requirements, set out in the SOM by the Board under the power of Section 5 of the Regulation. The same requirements apply to all cadastral surveys, irrespective of whether the plan is to be lodged as a Registered Plan, Identification Survey plan, Crown Plan, Deposited Plan or a Mining Plan.

The location of the survey also should not diminish the standards associated with the survey. Whether the land has a high or low value or is located in an urban or rural location, has no effect on the statutory requirements which are required to be met for the boundary/cadastral survey.

To conclude, a boundary survey in any format and irrespective of which Plan is utilised to depict the survey, is a cadastral plan and must meet the requirements of the Statutes, the requirements of the Board and Registering Authorities and should comply with 'established practices', unless there are good and valid reasons for departure from the 'established practices'.

⁴⁹ *Land Act 1994 (Q)* ss 278 et seq, where ss 280, 335, 352 and 356 have direct relevance to surveys and plans of surveys: and *Land Title Act 1994 (Q)* ss 28 et seq, where ss 29(2), 30, 65(2), 83A have direct relevance to surveys and plans of surveys. *Survey Coordination Act 1952 (Q)* ss 8, 9.

August, 1997

General Information

1.0 Historical Marking (Section 26 Surveyors Regulation 1992)

During survey, consideration shall be given to historical marking.

Survey legislation prior to 1977 provided for the following types of marking.

1.1 Pointer Pegs

Adjacent to portion and road corners in country lands, split hardwood pegs, free of sap wood, twelve inches (300mm) long and one and a half inches (40mm) square, were driven level with the surface of the ground. These pegs were aligned with the theodolite in the direction of the boundaries, and driven at exact distances, generally of twenty links (4.023m) from corner posts.

Pointer pegs first appeared in the Queensland General Directions of 1878. They continued in use up till the 1950's (not placed by all surveyor's) and did not appear in the 1964 Rules and Directions for the guidance of Surveyors.

1.2 Reference Tree

Reference trees were used for the early surveys in Queensland from 1839 onwards but it was not until 1898 that surveyors were required to cut a bench mark at the base of the tree for a traverse connection to a property corner. Prior to 1898, surveyors took connections to the shield on the tree.

Reference trees are still considered to be excellent reference marks, particularly in rural areas without extensive closer settlement. Surveyors should be aware of Vegetation Protection Orders, environment considerations and in particular the ecology balance for mud-flats, mangroves and the like.

When reinstating corners, if the reference tree appears to have been destroyed, decayed or burnt, a diligent search must be made for the butt of the tree or remains of the tree.

When a tree is used as a reference mark, the bark should be removed in the form of a shield about 1.5 metres from the ground and exactly facing the corner. On this barked space a broad arrow and the lot number are cut into the heart-wood. The bearing and distance should be observed from the corner to a chisel cut in the centre of a bench mark cut well into the heart-wood at the base of the tree and exactly facing the corner.

As of 1978, surveyors reverted to reference from corners to trees and not from trees to corners.

The Board does not encourage the continued use of Reference Trees, except in special circumstances, e.g. large rural surveys.

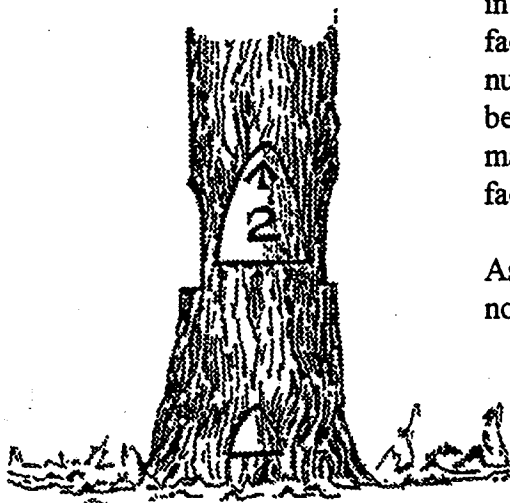

Corner Tree -
Country Portion

1.3 Survey Post

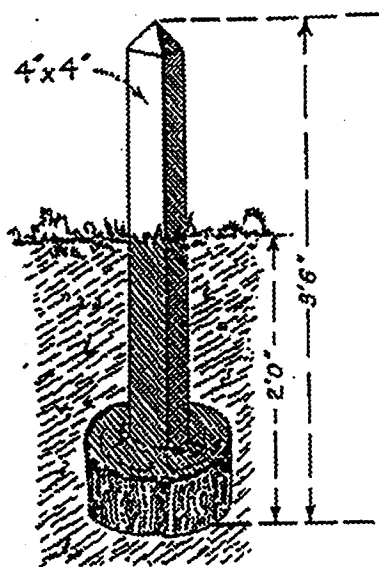

A survey post was cut from hardwood, three feet six inches (1.05m) long and dressed to no less than four inches (100mm) square, with a butt six inches (150mm) long and the full round size of the timber left on the bottom of the posts and the top pointed as indicated in the diagram.

Survey posts are still acceptable for marking corners, particularly in rural areas where there is no immediate likelihood of the fencing of boundaries proceeding.

When reinstating a corner where a survey post had originally been placed but now appears to be gone, a diligent search must be made for the butt or remains of the survey post below ground level.

*Corner Post. Country Portion
showing butt.*

Survey posts came into general use on country portion surveys by 1870 before this "large stakes" were in use.

1.4 Lockspits

The word 'lockspit' derives from the ancient terms for whole ('lock') and turf ('spit').

The principal corners of the portions were marked by corner posts. Outside a fifteen inch (37mm) radius from the posts, lockspits three feet (900mm) long and six inches (150mm) deep were dug in the direction of boundary lines.

On very stony lands, rows of stones placed in the direction of the surveyed line were substituted for dug-out lockspits. In dense scrubs, or where soils were of such a nature that lockspits quickly filled up and consequently were useless as permanent indicators of direction of survey lines, they were omitted.

Lock spits first appeared in the New South Wales Instructions for Marking Crown Land by Government Surveyors in 1853 but have been used long before this in New South Wales and overseas as marking for boundaries. The first appearance of them is in the 1878 Queensland General directions and they were used up until the 1950's but were not included in the 1964 Rules and Directions (They were rarely used in the 1940's and 1950's).

1.5 Line Pegs

At distances not exceeding ten chain (201.168m) apart, and always so situated as to be visible one from the other, split hardwood pegs one foot six inches (450mm) long and two inches (50mm) square, clear of sap wood, were aligned with the theodolite and driven fourteen inches (350mm) into the ground.

Line Pegs first appeared in the 1878 General Directions of Queensland and their use continues right up to present time.

1.6 Fence Traverses - Grazing Farms

The survey legislation of 1964 (Rules and Directions) detailed the method of traversing and marking fences that were used as the boundaries of Grazing Farms.

In the survey of Grazing Farms, fences were traversed only and suitable fence posts (preferably strainer posts), adopted as corners or corner pegs or posts placed near or under the fence. The straight lines between corners were computed and adopted as boundaries, care being taken that the distance of the fence from the computed boundary nowhere exceeded about 20 links (4m) and that the corners were not more than 80 chains (1600m) apart.

The fence posts so adopted were marked with a broad-arrow, and, if no tree was available, marked with the portion number also, iron pins were placed in accordance with Clause 58 of the Rules and Directions.

As it was desired to preserve traverse lines along fences forming portion or road boundaries in grazing area, such traverses were marked by placing a hardwood peg two inches (50mm) square and eighteen inches (450mm) long under or beside the fence opposite each picket, the chainage and offset in each case being recorded in the field notes and the nearest convenient tree blazed on three sides.

As some uncertainty seemed to exist among surveyors as to the method of traversing and pegging fences to be adopted as boundaries of Grazing Farms, the following rules were to apply:

- 1.6.1 As the fence is the physical boundary, the computed lines between corners were to be kept as close to the fence as possible so that areas were not greatly affected
- 1.6.2 The traverse lines were to be kept reasonably close to the fence to facilitate the placing of pegs under (or beside) the fence;
- 1.6.3 Pegs two inches (50mm) by two inches (50mm) by eighteen inches (450mm) were to be placed under the fence square off pickets not more than 20 chains (400m) apart;

- 1.6.4 A corner peg 3 inches (75mm) by 3 inches (75mm) by 18 inches (450mm) was to be placed under the fence where there was a definite bend, or, the strainer post adopted, but otherwise corners were to be established not more than about 80 chains(1600m) apart;
- 1.6.5 In order that the traverse lines could be easily re-established, a careful offset was to be taken from the traverse line to each peg and recorded in the field notes. (No attempt was to be made to place intermediate pegs on the computed through line);
- 1.6.6 The computed line, fence and pegs were shown in the centre column of the field book - the traverse lines on the relative side;
- 1.6.7 When intersecting or commencing on a previously traversed fence, the traverse line was to be established and the corner placed on the original computed line;
- 1.6.8 When fence traverses and intersections as above were required by instructions of even date- the post or peg was to be placed under the fence and used as a corner when computing the boundaries along the fence line.

It is important for surveyors to realise that pegs found under or beside such fences were not necessarily on the boundary which is the straight line computed between the adopted corners.

The relationship between the pegs found and the computed boundary can be calculated from the information supplied by the surveyor in his field book.

See Diagram.

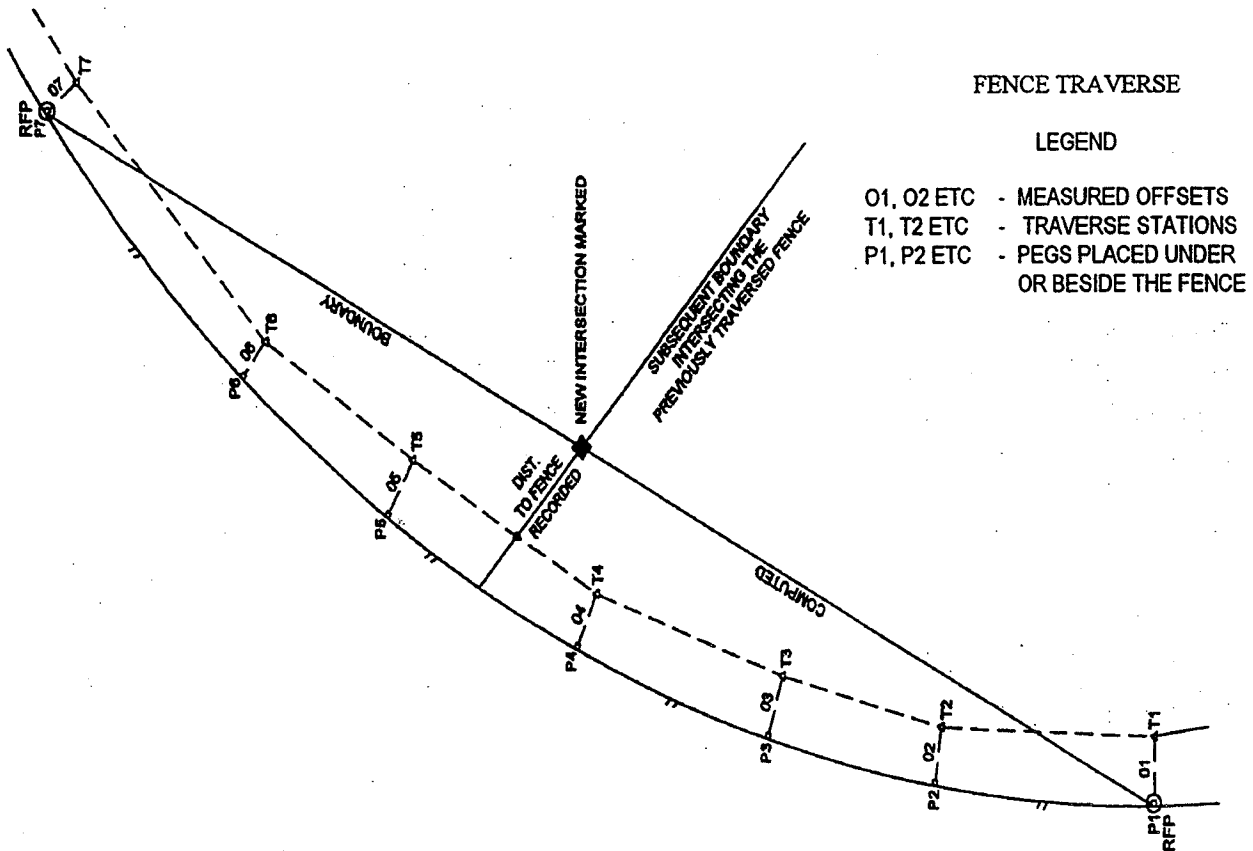

3.0 Major Qld Legislation Affecting Surveyors

Short Title	Admin. Dept
Surveyors Act 1977 and Regulation 1992	DNR
Survey Co-ordination Act 1952	DNR
Special Freeholding of Leases Act 1991	DNR
Land Act 1994	DNR
Building Units and Group Titles Act 1980	DNR
Acquisition of Land Act 1967 and Regulation 1993	DNR
Land Title Act 1994 and Regulation 1994	DNR
Miners' Homestead Leases Act 1913	DNR
Place Names Act 1994	DNR
QLD Boundaries Declaratory Act 1982	DNR
Water Resources Act 1989 and Regulations	DNR
Irrigation Areas (Land Settlement) Act 1962	DNR
River Improvement Trust Acts 1940 and Regulation 1987	DNR
Beach Protection Act 1968 and Regulations	DE
Canals Act 1958 and Regulation 1992	DE
Contaminated Land Act 1991 and Regulation 1991	DE
Property Law Act 1974 and Regulation 1993	DJ
Dividing Fences Act 1953	DJ
Workplace Health and Safety Act 1995 and Regulations	DTIR
Local Government Act 1993 and Regulations 1994	LGP
Local Government (Planning & Environment) Act 1990	LGP
City of Brisbane Act 1924 and Regulation	LGP
Integrated Resort Development Act 1987	LGP
Mixed Use Development Act 1993	LGP
Mineral Resources Act 1989 and Regulation 1990	DME
Coal Mining Act 1925	DME
Petroleum Act 1923	DME
Petroleum (Submerged Lands) Act 1982	DME
Industrial Development Act 1963 and Regulations	DTIR
Transport Infrastructure Act 1994	DOT
Transport Infrastructure Act (Rail) Act 1991 and Regulations	DOT
Transport Infrastructure Act (Roads) Act 1991 and Regulations 1991	DOT

In addition to the above, there are a number of Government practices which are in existence in Queensland which may not be contained in the above. The onus is on all Registered persons to familiarise themselves with these practices. The majority of these practices are detailed in Parts E3 and E4.

Limited list. For specific details, contact the relevant Department.

All Queensland Acts are available only from GOPRINT, 371 Vulture Street, Woolloongabba, Q 4101.

TEL: 3246-3399 or FAX: 3246-3534

(see over for legend to Administering Departments)

Department of Mines and Energy 61 Mary Street, BRISBANE Q 4000 G.P.O. Box 194, BRISBANE Q 400 TEL: 3237 1435; FAX: 3229 7770	MINES
Department of Natural Resources Cnr Main and Vulture Streets, WOOLLOONGABBA Q 4102 Locked Bag 40, COORPAROO DELIVERY CENTRE Q 4151 TEL: 3896 3111; FAX: 3896 3275	DNR
Department of Housing, Local Government and Planning 61 Mary Street, BRISBANE Q 4000 GPO Box 690, BRISBANE Q 4001 TEL: 3227 7111; FAX: 3224 5589	LGP
Department of Environment 160 Ann Street, BRISBANE Q 4000 PO Box 155, NORTH QUAY B 4002 TEL: 3227 7111; FAX: 3227 6485	DE
Department of Training and Industrial Relations Cnr George and Ann Streets, BRISBANE Q 4000 Locked Mail Bag 527 G.P.O. Q 4001 TEL: 3239 3111; FAX: 3229 0445	DTIR
Department of Justice 50 Ann Street, BRISBANE Q 4000 GPO Box 149, BRISBANE Q 4001 TEL: 3239 3520; FAX: 3221 2534	DJ
Department of Transport 85 George Street, BRISBANE Q 4000 GPO Box 1549, BRISBANE Q 4001 TEL: 3834 2011; FAX: 3834 2022	DOT
Department of Primary Industries 80 Ann Street, BRISBANE Q 4000 GPO Box 46, BRISBANE Q 4001 TEL: 3239 3111; FAX: 3221 2490	DPI
Department of Main Roads 477 Boundary Street SPRING HILL QLD 4004 TEL: 3834-2959; FAX: 3834-8012	DMR

4.0 COUNTY ADOPTED MERIDIAN TO AUSTRALIAN MAP GRID

The attached table provided additions (in degrees and minutes) to be applied to County Adopted Meridian (CAM) bearings to obtain Australian Map Grid (AMG) bearings.

The addition is a general value for a County and has an accuracy of +/- 1 minute, however in some places the error reaches 2 minutes.

It is appropriate to use information from this table when a survey plan has not astronomical observation but is related to CAM.

Where a survey plan has an astronomical observation the Grid Convergence should be calculated and added to the true bearing to obtain AMG bearing (grid bearing).

NOTE: AMG Grid Convergence is -

+ east of central meridian
and - west of central meridian

The three AMG zones covering Queensland are:

Zone	Western Boundary	Eastern Boundary	Central Meridian
54	138°E	144°E	141°E
55	144°E	150°E	147°E
56	150°E	156°E	153°E

On the attached table where a County crosses zone boundaries, a correction is provided for each zone with the appropriate zone number.

There is a different CAM to AMG conversion because of the opposite sign of the AMG convergence in each zone, one is east - the other is west of their respective Central Meridians. Also, the difference in longitude between the initial point of the County and the Central Meridian of each zone contributes to the difference.

TABLE SHOWING APPROXIMATE ADDITION TO CONVERT BEARING FROM CAM TO AMG

(For most parts of most counties the angle given is within +/- 1 minute. However, in some places the error reaches 2 minutes.)

Table with columns for county names (e.g., Abbotford, Aberdeen, Albany) and corresponding conversion values (e.g., 5 11, 8 01, 5 44). The table is organized in a grid format with 24 columns.

Technical Information

1.0 High Water Mark

1.1 Introduction

This Section is provided to assist Surveyors in using their professional judgement in determining High Water Mark. Reinstatement principles apply to High Water Mark boundaries in the same way as they apply to right line boundaries in that all of the available evidence needs to be collected before deciding on the original position or the altered position of the boundary.

There is a wide range of legislation, case law, and Directions issued by the Surveyors Board or the Department of Natural Resources that impacts on the use and administration of land and waterways adjacent to a High Water Mark. In determining how to deal with any land affected, consideration should also be given to the other relevant legislation and regulations.

1.2 High Water Mark

High Water Mark is an ambulatory boundary. The survey requirements for, and actions applicable to, this class of boundary are detailed in other sections of this manual. Please refer to the following:-

Survey Plan Guidelines - Section 1.32, High Water Mark, Part E2.

Survey Plan Guidelines - Section 1.53, Reserved Esplanade, Part E2.

Survey Plan Guidelines - Section 1.69, Watercourses, Part E2.

DNR Requirements for Surveys, Section 6 and its Sub-Sections 6.1 to 6.6 Ambulatory Boundaries, Part E3.

DNR Requirements for Surveys, Section 10.4 Esplanades, Part E3.

DNR Requirements for Surveys, Section 10.9 Esplanades, Part E3.

Directions and Recommended Practices - Section 5, Definitions, Part E1.

1.3 Mean High Water Spring Tide (MHWS)

There appears to be no technical definition of the term Ordinary High Water Mark at Spring Tides available. In the calculation of the height of High Water Ordinary Spring Tides, Pillsbury¹ explains that in the UK (where these terms originate) tides which are considered to be very different from the norm are omitted from the calculation. By analogy it is expected that the similar term "Ordinary High Water Mark at Spring Tides" would be treated in the same manner. Accordingly, calculation of "Ordinary High Water Mark at Spring Tides" is subject to professional judgement of the person computing the height when selecting those tides to exclude.

Note: Also refer to *N Svendsen vs State of Queensland and Anor*, Qld Supreme Court, No 32 of 1996, Demack J - April, 1999

Recognising this obstacle, the Departmental (Transport) practice has been to accept the height of Mean High Water Spring Tide (MHWS) as substitute for the "Ordinary High Water Mark at Spring Tides". MHWS is easily calculated by rule and includes all spring tides in the calculation. Statistically in the long term, the values of Ordinary High Water Mark at Spring Tides and MHWS will be the same.

¹ Pillsbury, G.B. (1956) *Tidal Hydraulics*, Corps of Engineering, US Army, Army-MRC, Vicksburg, Mississippi.

1.4 Diurnal Tides

The definition of spring tide cannot be applied to tides which are diurnal in their form (ie 1 tide per day) such as the Gulf of Carpentaria. This diurnal tide case is too difficult to incorporate in general rules and in any event has little practical significance. At the worst case it would fall to practical people to set a "reasonable" equivalent HWM boundary line at the time of survey.

In all cases Surveyors should use their professional judgement as to the position of the High Water Mark on the ground. In complex cases or where doubt exists additional specialist advice should be sought.

1.5 Mean Conditions

Attention is drawn to the fact that all the tidal levels refer to "mean" conditions. Accordingly there will be times when the tides flow onto the landward side of any HWM boundary.

1.6 Tidal Database

The Department of Transport has at its disposal the Queensland Tidal Database which contains tidal levels for a large number of coastal places. This information could be made available to Surveyors.

1.7 Methods for determining position of a tidal boundary

Article 22 of the Manual of the New South Wales Integrated Survey Grid, published by the Department of Lands NSW, provides some details of tidal boundaries. The article also includes a number of methods of determining the position of a tidal boundary. The methods are listed below:

1.7.1 Levelling from a bench mark**1.7.2 Levelling from a local tide gauge****1.7.3 The range ratio method**

These methods are suitable for the determination of both MHW and MHWS. Additionally the following procedure could be included as a fourth method.

1.7.4 Height Transfer at High Tide

It is required to locate the HWM - Ordinary High Water at Spring Tide. In accordance with paragraph 1.3, Mean High Water Spring Tide is an appropriate measure of the height of Ordinary High Water Mark at Spring Tide.

By reference to the nearest Standard Port listed in the Qld Tide Tables, select a tide which is predicted to rise to approximately the height of MHWS (within a few centimetres).

Observe the height of that high tide at the survey site and at the Standard Port.

Prior arrangements should be made with the authority controlling the standard port tidal station to obtain the required tidal heights from that station. It may take several weeks before the standard port tidal heights can be made available.

Confirm the height determination by observing the high tides 25 hours before and after the selected tide.

Because the selected tide may not rise to exactly the predicted height, it is advisable to correlate the observed tides at both places. Use the height of the Mean High Water Spring Tide (MHWS) at the Standard Port to estimate the equivalent height (MHWS) at the survey site. An example calculation is included below.

Locate the intersection of the Mean High Water Spring Tide plane on the ground. That line is the best estimate of the line of Ordinary High Water at Spring Tide.

This procedure should not be used during times of abnormal weather or flooding. Subject to this proviso and in cases where the position of the line is not critical, tidal predictions may be used in lieu of the observations at the standard port.

1.7.5 Sample Calculation

The following sample calculation, which is based on the table on the following page, is provided for guidance.

To obtain a transferred height at the survey site.

Subtract the height in Column 2 from the height of MHWS at the Standard Port and add the height in Column 3.

MHWS - Column 2 + Column 3 = estimate of MHWS at the survey site, eg

$$(1) \text{ for the tide 25 hours before: } 2.16 - 2.14 + 1.27 = 1.29$$

$$(2) \text{ for the tide at the selected date: } 2.16 - 2.28 + 1.41 = 1.29$$

$$(3) \text{ for the tide 25 hours after the selected date: } 2.16 - 2.39 + 1.52 = 1.29$$

Note- It is not usual to obtain the same value for each estimate of MHWS.

If it is acceptable to use tidal predictions from the Standard Port in place of the observed heights then use the heights from Column 1 in lieu of the heights from Column 2 in the formula.

Example Calculation - Height Transfer at High Tide					
Survey Site: Standard Port:			Some Place Brisbane Bar		
Column 1		Column 2		Column 3	
Brisbane Bar		Brisbane Bar		Some Place	
Predicted High Tides only		Observed High Tides		Observed High Tides	
Time	Height m Port Datum	Height m Port Datum	Height m Port Datum	Height m AHD (D)	
25 Hrs before	1023 2.04 2230 1.50	2.14		1.27 N/A	
Selected date	1104 2.16 2255 1.63	2.28		1.41 N/A	
25 Hrs after	1215 2.30	2.39		1.52	
Brisbane Bar Mean High Water Spring Tide: 2.16m Source: Queensland Official Tide Tables					

Note: in this example, the observed tides are approximately 0.10m higher than they were predicted to be.

2.0 Alternative Survey Methods - GPS

The Department of Mines and Energy have provided a guideline for GPS Surveys to be lodged with M & E. These guidelines are available from the Department on request.

3.0 Easement Surveys

Easement surveys are cadastral surveys and shall be carried out in accordance with Section 24 of the *Surveyors Regulation 1992*.

3.1 Deemed Tramway Easements

3.1.1 Historical Legislation

The Sugar Experiment Stations Act 1948 amended legislation:

- Requiring the Central Board to keep a "Register of Easements",
- Empowered the Central Board, upon application by a mill owner, to grant an easement upon any land for tramway purposes, and
- Created Deemed Easement rights to mill owners who constructed tramlines prior to 25 October 1948.

The registration of such easements in the Register of Easements was considered to be full and sufficient notice to all persons of the interest created in favour of the mill owner.

It was further specified that the Real Property Acts 1861 were to be read subject to the above provision.

The 1948 legislation provided for statutory easements with a width of eight feet (approximately 2.5 metres) either side of the centre line of the tramway, for all tramways constructed prior to 25 October 1948.

3.1.2 Existing Legislation

The *Sugar Industry Act 1991* provides for the following:

- Repeal of previous legislation,
- Vesting of the granting of easements and maintenance of the register to the Queensland Sugar Corporation,
- Continuation of the statutory easements created in relation to tramways constructed prior to 25 October 1948,
- Introduction of a sunset clause whereby statutory easements will cease to exist if not recorded in the Register of Easements before 30 June 1996, and
- Obligation by the mill owner to notify the Registrar of Titles once an easement has been granted, so that an Administrative Advice can be attached to the Title for the land being encumbered.

The Department of Natural Resources advise that such notifications are being sent to the Registrar of Titles.

4.0 Unmarked Corners and Boundaries

Refer to Section 27 of the *Surveyors Regulation 1992*.

- 4.1 Where a surveyor is satisfied that a corner or boundary under survey should not be or cannot be marked, the following procedures shall apply:
 - 4.1.1 Sufficient control shall be established as would permit any unmarked corner or boundary to be readily marked or reinstated at a future date from that control;
 - 4.1.2 The accuracy of the unmarked boundary as calculated through the control is shown to be of the same accuracy as is required of the whole survey or a higher accuracy;
 - 4.1.3 Corners and boundaries left unmarked are clearly shown as such in survey records and on the plan.
- 4.2 Where a surveyor is required to mark any previously unmarked corner or boundary, Section 26 shall apply.

5.0 Unsurveyed Railway Boundaries

Refer to Section 26 of the *Surveyors Regulation 1992*.

- 5.1 Prior to 1914, surveys of railway land were not normally carried out unless the land was being resumed from a surveyed portion held under leasehold or freehold tenure.
- 5.2 Section 92(1)(3) of the *Railway Act 1914* vested in the Commissioner of Railways, all Crown Land within railway fences. It is generally accepted that this applied only to land fenced prior to 1914.

As there is usually no conclusive evidence as to the age of the fences it has normally been sufficient, where unallocated state land or roads abut railway land, to adopt the fences as the boundary of the railway land.

Refer to item 1.4.4, page E2-17.

- 5.3 Under Section 214 (1) of the *Transport Infrastructure Act 1994* existing Rail Corridor Land became unallocated State land, to be leased to the State under the *Land Act 1994* Section 17 (b) and subleased to Queensland Rail. The State of Queensland will be represented by the Chief Executive, Queensland Department of Transport.
- 5.4 Under Section 215 (1) of the same Act, within 5 years Queensland Rail must identify the boundaries of existing Rail Corridor Land by compilation, survey or another way sufficient to identify the land. This land is to be referred to as a rail transport corridor, unless otherwise indicated by the Queensland Department of Transport.

6.0 Resumption Boundaries

Refer to Section 24 of the *Surveyors Regulation 1992*.

- 6.1** Where a survey is required of land to be resumed, the plan(s) shall show the boundaries of the land to be resumed and the balance of the lots affected by the resumption.
- 6.2** Resumption lines shall be marked where they intersect the common boundaries of parcels held under one ownership with separate titles or under consolidated titles.
- 6.3** Where permanent fencing has been erected along a resumption boundary prior to the survey, the surveyor, unless otherwise advised, must consult with the resuming authority to confirm that the fence should be adopted as the resumption boundary.
- 6.4** Where a resumption plan indicates that an area of road is available for closure, sufficient survey shall be carried out to enable the road to be closed if required or to remain open if application for closure is not forthcoming.
- 6.5** Where land is being taken by resumption, boundaries shall be cleared and marked except where unnecessary damage to cultivation or the environment would result, in which case concurrence of the Constructing Authority should be obtained.

7. Cadastral Surveys using GPS

7.1 Introduction

This chapter offers guidance for the performance of cadastral surveys using the Global Position System (GPS). The chapter has three sections:

Housekeeping and over-arching points are in this introduction section, Deals with those issues specific to making the measurements required for a cadastral survey with GPS,

The final section deals with aspects specific to the cadastral survey but is based on the concept that GPS is just another measurement tool available to the surveyors and that the underlying principles of cadastral surveying prevail irrespective of measurement technology.

7.1.1 Relationship to other Documents

This chapter builds on national guidelines for GPS surveys and on existing Queensland guidelines for cadastral surveys and survey infrastructure. Therefore, as well as relevant legislation, this chapter should be read in conjunction with:

Standards and Practices for Control Surveys (SP1) published by the Inter-Governmental Advisory Committee on Surveying and Mapping (ICSM) and referenced later. The ICSM Best Practice Guidelines on Use of the Global Positioning System (GPS) for Surveying Applications (also referenced later). Surveyors Board memorandum (2/97) on Guidance to Surveyors in relation to Survey Infrastructure. Other relevant sections of the Surveyors Operations Manual (SOM).

It is important to understand the relationship between these documents. SP1 covers control surveys and sets the framework for measures of precision and accuracy (Class and Order) which apply to GPS. The ICSM Best Practice Guidelines sit below that covering GPS surveys which are not strictly control surveys. This chapter of the SOM relates those national documents to surveying in Queensland with particular emphasis on cadastral surveys.

Both SP1 and the ICSM Best Practice Guidelines are available via the Internet at: <http://www.anzlic.org.au/icsm/techpub.htm>

Digital copies (with free viewing software) are also available from DNR District offices.

7.1.2 Scope

There are already surveys in the registers which were undertaken (at least in part) using GPS. This chapter is based on experience gained from those surveys to date which can be grouped into the following categories:

- large rural subdivisions
- large rural surveys related to native title
- mining lease surveys
- long line easement surveys
- survey control for cadastral and "as-constructed" surveys in urban areas such as for new estate developments

Given the broad range of applications suitable for GPS, parts of this chapter will apply more comprehensively to some types of surveys than others. If a surveyor or another party (for example, relying on this chapter for contracting) believes their application does not fit easily within these guidelines, it should be discussed with the relevant DNR Senior Surveyor or DME Chief Surveyor, as appropriate.

7.1.3 Survey Infrastructure

The use of GPS for cadastral surveys should be seen as contributing to the State's spatial data infrastructure. Benefits to the infrastructure as a whole come from the integrating of surveys. There are also often direct benefits if connections are made to the state control network by enabling links to the design and non-cadastral survey tasks associated with the project.

However, it should be noted that irrespective of the desirability of connections to the state control network for furthering survey infrastructure goals, in the case of GPS, such connections are the cornerstone of legal traceability for the survey.

7.1.4 Searching / Planning with DNR

A cadastral survey using GPS requires more than the normal cadastral searching. Searching for permanent survey marks with suitable horizontal and vertical control information is also required. When planning a cadastral survey using GPS, surveyors are encouraged to contact the relevant DNR District staff who have a thorough knowledge of existing control, including those marks which have already been surveyed using GPS.

7.2 GPS Measurement Aspects

7.2.1 National Standards

As outlined previously, the standards framework for GPS observations for cadastral surveys in Queensland comes from ICSM's SP1 which was designed primarily to cover control surveys. For surveys below the level of geodetic control surveys, ICSM has also developed Best Practice Guidelines which should be used for cadastral surveys in Queensland.

The following comments offer interpretation of the ICSM Best Practice Guidelines in the Queensland cadastral surveying context.

7.2.2 Legal Traceability and Connection to State Control Survey

As outlined in Section 2 of the Best Practice Guidelines, GPS measurements are presently not legally traceable under the Australian National Measurement Act (1960). Given the legal implications of cadastral surveys, it is stressed that any survey without legal traceability is likely to be compromised when compared to a survey which is legally traceable.

There has been significant effort nationally to develop an acceptable process for achieving legal traceability for GPS surveys. ICSM is working with National Standards Commission (NSC) on a suitable process. That process will have two elements.

The first element is based on GPS surveys being connected to the geodetic network which can be traced back to the Australian Fiducial Network (AFN). The AFN, with its permanent trackers, can monitor the overall quality of the GPS system to ensure it is functioning within expected limits. The plan is that under the National Measurement Act the AFN can be a so-called *recognized value standard for position*. Under this process, it will be necessary for state verifying authorities to certify and maintain position traceability through the geodetic networks. Also, it is important to note that for GPS, the *physical quantity* under the Act is *position* not *length*, as it is for tapes or EDM. It should also be noted that position is a three dimensional quantity.

The second element is for the Best Practice Guidelines to set out procedures for GPS surveys and for those guidelines to be recognised in the NSC process. The current Best Practice Guidelines document is designed to satisfy that second element but may require amendment once the final process is accepted by NSC.

Until the national process outlined above is in place, some states have been unwilling to allow GPS to be used for cadastral surveys. In Queensland, the following interim approach is recommended for cadastral surveys.

The Best Practice Guidelines satisfy the second element of the proposed NSC process outlined above.

In the absence of the first element, traceability of position, the professional approach is for surveyors to enable future traceability by connection to the geodetic network. In Queensland, the geodetic network is referred to as the State Control Survey in the Survey Coordination Act and that term is used for consistency.

As position traceability is in three dimensions, connection of the GPS cadastral survey to the State Control Survey should be by GPS occupation of sufficient stations to allow closure on at least two sets of horizontal coordinates and relationship to at least one height.

Those stations should have horizontal coordinates with an order at least equivalent to the class of the GPS cadastral survey. For example, if the appropriate precision for the GPS cadastral survey is decided to be Class B, it should be connected to control stations with horizontal coordinates of at least 2nd order.

The required precision of the height for the control station may be high where height is used in the title (e.g. volumetric surveys). However, for most cadastral surveys, height precision need only be sufficient to maintain the required precision in the derivation of level terrain distances. As a rule of thumb, 6m in height equates to 1 part per million in correction from ellipsoidal to terrain distances.

Also, until the NSC process for traceability of position is in place, it is prudent to check the scale of GPS surveys by measurement of at least one GPS measured line with a suitably traceable EDM.

It must be noted that the above interim approach for Queensland does not guarantee traceability for GPS surveys but is the best approach available to deal with the present lack of traceability in a professional and prudent manner.

7.2.3 Phase Data vs Pseudorange

As also outlined in Section 2 of the Best Practice Guidelines, that document and the proposed method for attaining legal traceability apply only to measurements which rely primarily on so-called carrier phase measurements. Lower precision techniques such as point positioning or differential GPS (DGPS) rely primarily on pseudorange measurements which do not have legal traceability and will not have in the immediate future. Therefore, such techniques are not recommended for cadastral surveys in Queensland at present.

7.2.4 Standards of Accuracy

Section 3 of the Best Practice Guidelines outlines standards of accuracy. GPS Cadastral Surveys in Queensland should be carried out to at least Class C taking into account the following points:

A correctly performed GPS survey using phase data is a high precision technique, with results in each dimension usually better than 10mm plus 5ppm (one part in 200,000). As such, GPS surveys should generally exceed the requirements of Section 31 of the Surveyors Regulations (1992) for measurement (10mm plus one part in 10,000). However, it should be noted that GPS techniques are such that a cadastral line between two points may be considerably shorter than the GPS baselines which measure to those points. Where two cadastral points are significantly closer to each other than the distances to the GPS base station(s), it may be possible that the resulting relative error in the line between those cadastral points may be worse than required under Section 31. That resulting relative error could be reduced by measuring directly between the two cadastral points. This could be by GPS measurement or by distance and meridian observation using conventional technology.

The comment under Table 2 in the Best Practice Guidelines should be noted. It indicates that gross error is highly likely if the relative standard error ellipse exceeds 8cm. That effectively means that Class C can only be used for lines up to 2,500m in length; Class B up to 5,000m and Class A for any lines longer than 5,000m.

It should also be noted that, strictly speaking, Class can only be assigned based on the results of a minimally constrained least squares adjustment and ideally such adjustment should be undertaken. As a minimum, comparisons of coordinates resulting from multiple occupations of relevant stations in the survey should be done. That requires interpretation of statistics and confidence limits and is best illustrated by example. If two sets of coordinates were derived for the same station from 500m baselines and the survey was being done to Class B, one could be 39% confident of a relative standard error ellipse of 10mm (as per Table 2 in the Best Practice Guidelines). Statistics dictates that one could be confident that 99% of values would fall in an ellipse 3 times that size (30mm in the example). Therefore, as a rule of thumb, the horizontal misclose between coordinates from any two occupations should not exceed 3 times the value in Table 2 for the appropriate Class and line length.

7.2.5 Equipment Validation

Equipment validation is covered in Section 4 of the Best Practice Guidelines. It is not intended to make a decision regarding GPS test networks in Queensland until the national legal traceability procedure is finalised. In the interim, equipment can best be validated by comparison with existing Class AA GPS networks (such as the 100km network) and Class A GPS networks (such as the 3 to 5km networks in urban areas).

7.2.6 GPS Observational Techniques

Various observation techniques are covered in Section 5 of the Best Practice Guidelines, grouped as general and specific requirements. The following additional comments should be noted.

7.2.6.1 Geodetic Datum

Section 5 outlines the World Geodetic System 1984 (WGS84) and its relationship to the Geocentric Datum of Australia 1994 (GDA94). The present official horizontal datum for Queensland is the Australian Geodetic Datum 1984 (AGD84) and its map projection equivalent AMG84 which should be used for the presentation of results of GPS cadastral surveys. GDA94 is scheduled for adoption in Queensland in the year 2000.

Many processes in a GPS cadastral survey (such as distance reduction) require heights. The Australian Height Datum (AHD) is the appropriate vertical datum for presenting heights associated with a GPS cadastral survey. The latest available AUSGEOID model is recommended for converting GPS ellipsoidal heights to AHD heights.

7.2.6.2 Redundancy and Check Measurement

Throughout Section 5, mention is made of the need for check measurements in recognition of the fact that GPS, like any other surveying tool, can be subject to systematic and gross error. GPS survey techniques rely on resolving the so-called *ambiguities*. As well as site dependent errors such as multipath, incorrectly resolved ambiguities can occur due to problem data at either receiver and such errors can cause decimetre level errors. As a check on such errors all new stations should have sufficient observations for at least two independent determinations of the coordinates. That may be achieved by two independent GPS occupations or by one GPS occupation and sufficient conventional observations.

For truly independent GPS occupations, the most rigorous approach is a redundant network design linking new stations to the control stations, as required for legal traceability and testing of Class and Order.

A common alternative to the network approach involves radiation from a base station. In such cases, the most reliable result is obtained by reoccupation of all new stations from a second base station. That approach checks that no anomalies occurred at either of the base stations or at any of the new stations.

Where only one base station is used, reoccupation only checks possible anomalies at each new station. At the least, a subset of new stations should be occupied using a second base station to guard against errors due to anomalies with base station data. Independent traversing from one control through the new stations and closing on the second control station would also check that possibility.

As well as a check against systematic or gross error in the GPS survey, re-occupations are also necessary to test the required class has been achieved for the survey.

7.2.6.3 The Real Time Kinematic Technique

The so-called real time kinematic (RTK) technique is not specifically covered in the Best Practice Guidelines at present. That technique should be undertaken in line with the *Observational Requirements for Kinematic Baselines*. Given the very short occupation times used in RTK, the likelihood of error due to undetected multipath or incorrectly resolved ambiguities is increased. Therefore, the information in **Error! Reference source not found.** is particularly relevant to RTK.

It should also be noted that results are obtained in real time so many types of equipment can function without storing the raw data. However, it should be noted that later re-processing to identify suspected errors is only possible if the raw data has been collected.

7.2.7 Data Lodgment

The provisions of Section 6 of the Best Practice Guidelines are considered appropriate for Queensland. Lodgment of GPS processing result files and adjustment files (ideally as ASCII files) is desirable to enable incorporation of the GPS survey (especially permanent marks) into the geodetic network in the area and for effective future maintenance. This is also desirable to enable conversion from AGD84 to GDA94 when it is adopted.

All necessary Permanent Marks sketch plans should be lodged with the survey plan.

7.3 Cadastral Survey Aspects

7.3.1 Reinstatement

It should be noted that GPS is a measurement tool and its use does not preclude the normal need to make sufficient connections to reinstate all existing corners which affect the survey in question.

7.3.2 Marking

As with reinstatement, use of GPS does not preclude normal cadastral marking standards.

It should be noted that cadastral corners cannot always be occupied directly with GPS, due to obstruction of the sky and the like. In such situations the GPS part of the survey would occupy marks some distance from the corner. It would then be then necessary to use conventional survey equipment to connect to existing corners or place new corners and to connect to reference marks in the vicinity.

Azimuth for such connections would typically be obtained by placement of a second "*azimuth mark*" using GPS, by traversing between coordinated marks or by astronomical observation.

All points occupied with GPS should become reference marks and be marked accordingly. A reasonable subset of new reference marks should be permanent marks. Where GPS occupations are on temporary control stations which are likely to be disturbed during the project, steps should be taken to ensure final coordinates are propagated through to permanent marks.

7.3.3 The Survey Plan

All aspects of the survey plan, including meridian, bearing, distances, permanent marks (with their coordinates and heights and quality thereof) should be shown as for any other cadastral survey as covered elsewhere in the SOM.

A statement on the plan should indicate that all or parts of the survey were undertaken using GPS. Reference should be made to particular lines measured using GPS, particularly in the case of new boundaries. To assist future surveyors in recreating the survey, the statement should indicate the GPS technique used. The statement should use the following generic categories based on the terminology of the Best Practice Guidelines; static, quick static, pseudo-kinematic kinematic and real time kinematic. Therefore, an example statement may be; "Parts of this survey were undertaken with GPS using the fast static and real time kinematic techniques".

This page intentionally left blank.

This page intentionally left blank.

Table of the Counties of Queensland

TABLE OF THE COUNTIES OF QUEENSLAND
 Showing the COUNTY VARIATION and the Location (with Latitude and Longitude) of the INITIAL POINT for each.

Revised to 1st August, 1963.

Trigonometrical Station shown *
 Astronomical Station shown †
 Latitude Station shown ‡
 NOTE:—DATUM FOR LONGITUDE: No. 1. BENCH MARK, SURVEY OFFICE, BRISBANE—LONGITUDE 153° 01' 29"·6 E.

County	Initial Point	Latitude S.	Longitude E.	County Variation
Abbotsford	Station S (G. 250,199) on Rabbit fence, at north-west corner Ben Castle Block	26 39 53·0	141 23 56·4	5
Aberdeen	North corner portion 2, parish of Goongahilly	25 56 37·9	149 18 58·3	7
Albany	South-east corner View Hill Block, at tree marked broad-arrow over A over V	21 43 32	146 16 11	6
Albion	North-west corner portion 8, parish of Owl's Nest	21 23 42·6	142 46 07·6	5
Allison	North-west corner portion 5, parish of Collins	21 31 14·4	141 03 40·4	4
Amaroo	50-mile peg (Bedford's Survey, Trig. S. 9)	23 05 12·8	139 08 48·7	4
Archer	Tree marked broad-arrow over MD6 over B5, at north-west corner Meta Downs No. 6 Block	13 25 28	142 31 12	5
Argylla	Intersection peg at 161532 feet on the old Cloncurry—Mount Isa Road	20 41 12·7	139 53 36·2	4
Aubigny	Bloodwood Hill †	27 22 48·10	151 34 35·71	8
Auburn	North corner Police Reserve (R. 37), town of Chinchilla	26 44 28·7	150 37 29·5	8
Ayrshire	Winton †	22 23 11·94	143 02 25·49	5
Balarga	North-east corner Koolah No. 8 Block	15 10 20	142 42 09	5
Bando	North-west corner section 4, town of Coongoola	27 39 10·8	145 54 03·4	6
Banks	Crossing of closed Cooktown—Laura Railway over Normanby River	15 23 27·6	144 52 29·3	6
Barcoo	South corner portion 3, parish of Alibabah	24 27 08·7	144 14 20·2	6
Bauntina	Station 5 (Sh. 25) on east boundary portion 3, parish of Spottiswood	24 43 16·0	149 28 01·4	7
Beaconsfield	Cloncurry †	20 42 23·3	140 30 17·8	4
Beaufort	Hobartville Head Station	23 18 17	146 30 27	6
Bell	Twin Hills †	21 57 40·10	146 56 29·54	6
Belmore	St. George †	28 01 44·5	148 35 22·8	7
Belyando	Alpha †	23 39 01·05	146 38 33·7	6
Bentinck	Bullagaming Mountain *	28 35 05·73	151 24 50·46	8
Binburie	Brighton Downs †	23 21 54·52	141 33 47·55	5
Bolwarra	Tree marked broad-arrow over L over 102, in Bolwarra Holding, on Lynd River	17 31 40	144 04 27	5
Boondooma	Mount Dangore *	26 27 31·23	151 36 21·84	8
Bowen	Mount Perry †	25 10 38·5	151 38 31·9	8
Brahe	Tree marked broad-arrow over F over ND, at south-east corner Flora North Block	20 11 52	139 07 06	4
Brighton	South corner portion 6V, parish of Middleton, county of Woodstock	22 31 06·2	141 36 21·2	5
Buckingham	Tree marked broad-arrow over CXC over M7, at east corner Mungeterebar Holding	22 09 20	139 29 08	4
Buckland	Station 7 (Sh. 22) on south boundary portion 5, parish of Hawthorne	24 33 26·7	147 33 55·0	7
Bulgroo	Bulgroo Head Station	25 47 20	143 42 16	4
Buller	North-west corner Porta Down Block, near tree marked broad-arrow over C over EV	18 17 06	138 49 12	6
Bulloo	North-east corner portion 3V, parish of Andoch	27 02 25·5	144 09 20·4	4
Bulwer	Milla †	26 39 34·6	150 11 03·6	6
Burara	West corner portion 10, parish of Silverleaf	25 45 15·1	147 49 19·3	8
Buraria	North-east corner section IV, town of Moccundra	27 48 55	142 35 22	7
Burdakin	South-west corner portion 4V, parish of West Burdakin	19 51 28·3	146 21 37·4	5
Buranda	North-west corner east severance portion 5, parish of Barford	25 30 57·3	146 32 39·7	6
Burke	Burketown †	17 44 36·70	139 32 48·44	6
Burrandilla	South corner portion 18, parish of Burrandilla	26 09 02·2	145 49 22·1	4
Byerley	Tree marked broad-arrow over R over XLVI on Red River, at north-east corner Charnwood Holding	17 26 48	143 29 23	6

TABLE OF COUNTIES, WITH THE COUNTY VARIATION AND INITIAL POINT FOR EACH—continued

County	Initial Point	Latitude S.	Longitude E.	County Variation
Cairns	Station 55a (Cns. 23) on Road in portion 9, parish of Dunsmuir	22 36 55.5	148 14 40-6	7
Cameron	Yanco Head Station	28 35 20	141 53 30	5
Canning	North corner section 1, town of Woodford	26 36 27.4	152 45 51-1	9
Canobie	West corner Nooragal Block, at tree marked broad-arrow over Z over 17	19 30 40	140 46 09	4
Cardwell	Cardwell †	18 16 12.3	146 01 54-4	6
Carlisle	South-west corner section III, town of Mirani	21 09 37.9	148 51 54-2	7
Carmarvon	North-east corner portion 1, parish of Minned	28 18 26-4	149 53 08-7	8
Carpentaria	Tree marked broad-arrow over LXXX, near south-east corner Inverleigh No. 1 Block, at "M" Lagoon	18 06 32	140 16 55	4
Carrandotta	Tree marked broad-arrow over J over CXXIX, on Georgina River, near west corner Carrandotta Holding	22 00 00	138 29 55	4
Carruthers	260-mile post on Border Survey (M.51.99.)	29 00 00-0	141 22 35-1	5
Cassillis	North-east corner portion 4, parish of Heness	27 56 32.7	146 41 40-6	7
Cavendish	Perseverance Mountain	27 24 54-73	152 09 43-85	8
Chataway	North-east corner portion 2, parish of Egema	20 55 35-0	146 14 59-5	6
Chalsworth	North-west corner portion 7, parish of Mayfields	21 22 38-7	139 42 48-6	4
Chelmsford	South corner section VII, town of Maytown	16 03 06-1	144 17 10-6	5
Chesterton	North-east corner portion 1, parish of Altica	25 12 40-5	147 28 18-9	7
Cheviot	North corner section IV, town of Wellford	25 02 49-8	143 39 57-8	5
Chudleigh	North-west corner portion 1, parish of Stawell	19 54 39-5	143 54 42-8	5
Churchill	Mount Zabel	27 48 41-67	152 19 39-05	9
Clarke	Crossing of telegraph line over Gray Creek	18 57 44	145 03 04	6
Claude	Tree marked broad-arrow over C at junction Claude River and Goodlife Creek	24 31 42	147 05 00	6
Clermont	Clermont †	22 49 29-56	147 38 24-74	6
Clive	Gladstone †	23 50 25-91	151 15 27-24	7
Coen	Texas Mountain	28 51 25-66	151 12 40-04	8
	South-east corner Stralhearn No. 1 Block, at tree marked broad-arrow over S 1 over R 1	14 06 55	142 39 00	5
Cogoon	South-west corner portion 1, parish of Bullaroo	27 21 14-2	148 27 14-8	7
Conbar	Tree marked broad-arrow over W over 2, at north-east corner Ness Block	27 08 20	143 24 30	7
Conuelo	West corner portion 1, parish of Warrinilla	24 50 11-5	148 32 12-1	7
Cook	Bundaberg †	24 52 18-0	152 20 44-8	8
Cooper	Tree marked broad-arrow over C over 171, on Miaspoo Waterhole (Cooper's Creek)	27 35 45	141 15 10	5
Coorajah	East corner portion 2, parish of Coorajah	25 12 42-8	144 15 07-0	6
Cootah	West corner Drumduff Holdings	15 57 20	142 37 34	5
Copperfield	Compania Downs Head Station	18 43 02	144 19 09	5
Cozeena	North-west corner portion 10, parish of Buntthina, county of Evora	23 26 23-0	145 37 23-9	6
Cumberland	South-west corner R. 60, parish of Brompton	22 35 09-9	143 59 03-9	5
Curralle	Mount Howitt Head Station	26 30 57	142 15 57	5
Currawilla	Currawilla Head Station, at tree marked broad-arrow over F over XV	25 08 16	141 20 18	5
Dagmar	South-west corner R. 4, parish of Thornborough	16 56 51-0	145 00 13-3	6
Dalrymple	South-west corner portion 3, parish of Southwick	19 48 59-1	145 43 54-0	6
Daroo	South-west corner section IV, town of Betoota	25 41 45	140 44 46	4
Davenport	Charities Towers †	20 04 10-00	146 15 02-09	6
Dawson	Station 6 (Dw. 30) on north boundary portion 16, parish of Woolton	24 55 34-9	150 16 10-1	6
Deas Thompson	East corner portion 39, parish of Langmore	23 43 05-9	150 54 43-2	8
Denison	South-west corner section VII (School Reserve), town of Springsure	24 07 04-8	148 05 16-0	7

Location	Description	27	19	27-3	150	52	23-5	8
Derby	South-east corner portion 31, parish of Weranga	27	19	27-3	150	52	23-5	8
Diamantina	Davenport Downs Head Station	24	06	10	141	06	45	5
Dickson	East corner portion 3v, parish of Martyr	22	04	19-5	147	40	30-1	5
Douglas	Hughenden †	20	50	41-43	144	11	52-64	5
Drake	South-east corner portion 2, parish of Havilah	20	51	53-9	147	46	28-8	7
Drummond	Drummond Crossing over Alpha Creek at 199635 feet on Alpha-Tambo Road	22	06	09-4	146	37	15-4	6
Drury	Station 1 (Dr. 15) on south boundary portion 3, parish of Labona	24	06	09-4	146	19	35-7	6
Dublin	South corner portion 110, parish of Tyrconnel	26	27	04-1	147	32	10-7	7
Dulhunty	Moreton Telegraph Station	12	27	23	142	38	11	5
Dunbar	Tree marked broad-arrow over R over RP7, on Magnificent Creek, near Mitchell River Mission Station	15	28	44	141	44	15	4
Durham	Durham Downs Head Station	27	05	03	141	54	36	5
Durtic	Nurdah Out Station, at tree marked broad-arrow over I over XXX11	25	38	50	140	01	45	4
Dutton	North-west corner portion 4, parish of Fairlight	20	33	34-7	143	51	20-3	5
Eddington	Station 126 (En. 62) on south boundary portion 9, parish of Eddington	20	19	19-0	141	32	44-1	5
Eidsieigh	Tree marked broad-arrow over L, over L1 over 2, at north-east corner Fery Block	17	37	24	143	35	12	5
Elderslie	North corner portion 2, parish of Hallum	22	38	03-5	142	23	29-0	5
Elgin	Surat †	27	09	16-4	149	04	09-1	7
Elphinstone	Woodstock Railway Station, at 24 mile peg	19	35	52-5	146	50	12-3	6
Emerald	South-west corner Esmeralda Holding	18	39	55	142	16	25	5
Etheridge	North-west corner portion 19 (School Reserve), parish of Dumba	18	09	05-1	142	51	37-1	5
Eurynye	Tree marked broad-arrow over A over 81, on east boundary Feu East Block	24	08	09	139	47	70	4
Evora	North-west corner portion 10v, parish of Busthina	23	26	23-0	145	37	23-9	4
Eyre	North-west corner Glengyle Holding	24	33	30	138	26	54	6
Farrar	Conemara †	24	13	16-65	142	16	45-05	5
Ferguson	Banana †	24	28	47-0	150	07	40-8	8
Ferroy	North-west corner portion 3, parish of Deballada	23	04	10-3	142	54	18-4	5
Fielding	Tree marked broad-arrow over Z over XVIII, at north-west corner Rodetick Holding	19	04	42	141	55	40	5
Fitzroy	Nanango †	26	40	22-7	152	00	22-4	8
Flinders	Miriam Vale †	24	19	44-8	151	33	42-8	8
Fortescue	Taroom †	25	38	26-2	149	47	42-8	8
Foxton	Tree marked broad-arrow over A over 23, on Amelia C., in Amelia Creek Holding	21	06	15	145	40	36	6
Franklin	Vanhook Head Station	16	57	55	141	56	24	4
Fraser	Sandy Cape Lighthouse	24	43	53-6	153	12	31-9	4
Gayundah	North-west corner portion 1, parish of Clare	22	32	22-6	145	40	52-1	9
Georgina	South-west corner Aldetley Holding	22	38	45	139	08	50	6
Gilbert	Georgetown †	18	17	31-8	143	32	43-1	4
Gladstone	South-east corner Campings Reserve (R. 34), parish of Barratta	19	48	28-5	147	07	56-7	5
Glanworth	North-west corner portion 1, parish of Bekool	25	14	24-7	145	44	38-4	6
Glengyle	Tree marked broad-arrow over G over D7, at corner rabbit fence, at north-west corner Doyal Block	24	55	25	139	08	18	4
Glenora	Tree marked broad-arrow over C over G on Yappa River, at north-east corner Cowabunya Block	19	02	03	142	50	52	5
Gordon	Eromanga †	26	04	06-37	143	15	59-75	6
Gould	Tree marked broad-arrow over P over 1, at south-east corner Highbury Holding	16	33	58	143	13	03	6
Gowan	South-west corner portion 3, parish of Listowel	25	20	05-5	143	03	04-6	5
Granada	South-west corner portion 5, parish of Mellinda	19	50	35-5	140	22	06-9	4
Gregory	Landsborough's marked tree, marked broad-arrow over RTR over N 10 over 1862, on Gregory River, in Riverleigh Holding	18	55	26	138	56	54	4
Grey	Station 34 (Ca. 13) on north boundary portion 1, parish of Whitula	25	23	14-2	142	16	49-6	5
Griffith	South corner section VII, town of Pentland	22	03	39-0	145	23	51-7	6
Grosvenor	Grosvenor Downs †	20	03	02-0	148	07	49-0	7
Gunnawarra	North-west corner portion 2, parish of Kinrara	18	20	31-1	145	03	19-7	6

TABLE OF COUNTIES, WITH THE COUNTY VARIATION AND INITIAL POINT FOR EACH—continued

County	Initial Point	Latitude S.	Longitude E.	County Variation
Haddon	No. 1 Well, near Meeba Downs Station, in Westby Holding	25 47 35	141 27 18	5
Hamilton	Hamilton Tank	22 46 08	140 36 08	4
Hann	Musgrave Telegraph Station	14 46 57	143 30 07	5
Hesbert	Bowen †	20 00 50-6	148 14 51-4	7
Hillalong	Station 28 (Hln. 16) on east boundary portion 1, parish of Tiverton	21 07 18-4	148 19 43-0	7
Hodgkinson	South-west corner R. 4, parish of Thornborough	16 56 51-0	145 00 13-3	6
Howitt	North-west corner portion 7, parish of Smithburne	17 01 57-0	141 14 38-0	4
Humboldt	North-west corner allotment 1, section VI, town of Blackwater	23 35 10-1	148 52 51-7	7
Humeburn	North-east corner portion 6, parish of Natraport	27 19 18-9	145 00 14-6	6
Iffley	Iffley Head Station	18 52 19	141 12 25	4
Jardine	McDonnell Telegraph Station (Disused)	11 38 51	142 26 54	4
Kalkah	Tree marked broad-arrow over Y over 13, at south-east corner Minka Holding, on Coleman River	14 54 38	142 56 22	5
Kamillerol	Station 61 (Kl. 4) on south boundary portion 5, parish of Belfing	19 14 01-1	139 43 07-4	4
Kendall	North-west corner Meta Downs No. 4 Block, at tree marked broad-arrow over RES over MD4	13 41 15	141 58 00	4
Kennedy	Station-4 (Ke. 41) on west boundary portion 7, parish of Wallam	26 57 17-1	147 40 48-6	7
Killarney	Collaroy †	22 02 12-9	149 11 08-5	7
Kimberley	Duaranga †	21 42 54-6	149 40 22-2	7
King	West corner Strathmore No. 1 Block	15 51 50	143 16 51	5
Koolatah	Tree marked broad-arrow over R over 25, on Mitchell River	15 16 54	141 52 51	4
Kungie	10 mile post on Border Survey (M51.59), west of Warrego River	29 00 00-0	145 30 14-2	6
Kyabra	Station 21 (Kb 4) on west boundary portion 2, parish of Cooloo	26 05 48	142 57 12	5
Kyrunda	South corner allotment 5, section XI, town of Kynuna	21 34 55-1	141 53 13-9	5
	North-east corner portion 3v, parish of Norley	28 03 56-9	143 17 06-5	6
Labouchere	Taroom †	25 38 26-2	149 47 42-8	7
Lamington	Tree marked broad-arrow over C, at north-east corner Yapparton Holding	18 24 20	141 34 55	4
Landsborough	South-east corner portion 2, parish of Goorala	19 15 25-7	140 09 58-0	4
Lang	North-west corner portion 19 (School Reserve), parish of Bumba	18 09 05-1	142 51 37-1	5
Langlo	South-west corner portion 2v, parish of Langlo	25 41 01-7	145 38 44-5	6
Lennox	Kilkivan †	26 05 09-1	152 14 34-7	8
Leura	North-east corner portion 1, parish of Defarge	22 51 28-2	149 20 37-3	7
Liebig	Marborough †	22 12 28-3	149 52 43-0	8
Livingstone	Rockhampton †	23 22 46-0	150 30 44-3	8
Lukin	Tree marked broad-arrow over RES over D3, on Edward River, at south corner Bathwick No. 3 Block	14 40 09	142 01 40	4
Lynd	11 miles 40 chains on Etheridge Railway, on bridge over Tate River	17 28 35-9	144 37 25-0	5
Lyndhurst	Crossing of Peninsula (Developmental) Road (Main Roads plan 43399) over Emsaleish River, near Lyndhurst Head Station	19 12 13-0	144 22 13-2	5
Lytton	Jandowae †	26 46 58-7	151 06 36-5	8
Mackenzie	Gayndah †	25 37 37-3	151 36 41-5	8
Maitwa	South-east corner Eton Vale No. 2 Block	23 48 40	140 21 33	4
Maneroo	West corner portion 10v, parish of Evesham	23 11 34-5	143 37 33-9	5
Manfred	South corner portion 3, parish of Lam	20 12 46-6	141 37 43-2	5

Manuka	North-east corner portion 1, parish of Manuka	21	35	50-1	143	19	39-5	5
Maramee	West corner portion 2, parish of Dromore	16	07	24	142	26	38	7
March	Maryborough †	27	34	16-8	148	07	16-6	9
Marga	South corner Staaten River Holdings, near tree marked broad-arrow over W over 21	25	32	16-0	152	42	06-9	5
Marsh	Inglewood †	17	03	10	142	24	50	5
Mayne	Dunham Towers Out Station, in Curcara Holding	28	23	06-5	151	04	23-6	8
McKinlay	Adavale †	23	52	38	142	18	42	5
Melville	Cape Bowen	25	54	39-48	144	35	34-59	6
Merivale	Mount Gammie	14	30	33	144	39	55	5
Merlin	Selwyn Railway Station	28	07	03-13	151	42	24-35	8
Mexico	South-west corner portion 9v, parish of Burgoyne	21	31	43-2	140	30	01-6	4
Mitchell	South-west corner portion 4v, parish of Thornfield	23	48	56-0	146	04	58-7	6
Monkira	Tree marked broad-arrow over 1 over XXI, on Mackhara Waterhole	24	24	12-2	146	50	18-7	6
Morstone	West corner Rocklands No. 6 Block, near tree marked broad-arrow over LXXXIII	24	47	52	140	37	33	4
Mosman	Crossing of telegraph line over Kennedy River, at tree marked broad-arrow over B	19	23	07	138	19	39	4
Mowarra	South-west corner portion 9, parish of Drylands	15	25	42	144	10	55	5
Mueller	South-east corner Adavale Block, near tree marked broad-arrow over AV over AVJ over HP3	24	57	00-0	142	18	13-6	5
Munga	over HP3	18	29	22	138	12	54	4
Mungallala	North-east corner portion 7v, parish of Orkadilla	26	08	50-5	147	12	26-2	7
Murchison	South-east corner portion 1, parish of Yunnernman	27	59	13-7	147	06	21-8	7
Murray	St. Lawrence †	22	20	50-5	149	32	04-9	7
Musgrave	South-west corner portion 1, parish of Robey	20	23	03-3	146	56	51-4	6
	South corner portion 1, parish of Silsoe	23	29	41-4	143	30	18-6	5
Nares	Cairns †	16	55	27-77	145	46	48-14	6
Nebine	North-west corner Chad Holding, near tree marked broad-arrow over CH over GF	20	42	40	138	31	36	4
Newcastle	Iron pin, near north-west corner section III, town of Togo	28	50	56-1	146	47	06-0	4
Nicholson	Hawkwood †	25	46	58-3	150	48	59-7	7
Nickavilla	Tree marked broad-arrow over C, on Cliffdale Creek, at crossing of Darwin Road	17	35	50	138	26	28	8
Nive	South-east corner P.P.1, parish of Gunnadorah	26	30	57-9	144	19	45-8	4
Noorama	South-east corner north severance portion 2, parish of Malta	24	50	30-4	146	46	14-2	6
Norley	South-west corner portion 3v, parish of Weedamurra	28	23	33-6	146	11	44-4	7
Norman	Tree marked broad-arrow over K over B over B, near Teebailah W.H., north-east corner Klandra Block	27	27	20	143	56	37	6
Norman	Normanton †	17	40	14-33	141	04	37-34	4
Nyama	65-mile post on Border Survey (MS1.99)	29	00	00-0	144	35	44-1	6
	Tree marked broad-arrow over U over 12, on Umpadilboo Creek	24	42	45	139	55	55	4
Oaklands	Blackbull Railway Station, at 56 miles 52 chains	17	56	28-9	141	45	08-6	4
O'Connell	Tree marked broad-arrow over XI, on Burdekin River, on north boundary	19	10	34	145	27	23	6
Gondooroo	Merino Block	22	07	41-4	143	07	12-8	5
Orrery	North-east corner portion 1, parish of Mills	26	03	01-6	146	38	12-5	6
	South-east corner portion 46v, parish of Hood	19	11	10	143	56	46	5
Percy	Tree marked broad-arrow over D over B1, at junction Duffer Creek and Styk River	19	40	04	144	53	11	5
Philp	Wando Vale Head Station	28	08	49-5	142	40	02-9	6
Pitteroo	Station 17 (G. 250.236) on rabbit fence, at north-east corner Whippa North Block, at tree marked, broad-arrow over RP	21	36	43-7	138	19	10-4	4
Piturie	East corner section III, town of Urandangie	23	44	21-1	147	29	50-0	7
Porchester	North corner portion 44v, parish of Woodbine	17	44	38-70	139	32	48-44	4
Portland	Burketown †	23	26	39-52	144	14	53-84	4
Pring	Longreach †	27	46	10-1	149	58	27-1	8
	South-west corner section IV, town of Southwood							

TABLE OF COUNTIES, WITH THE COUNTY VARIATION AND INITIAL POINT FOR EACH—continued

County	Initial Point	Latitude S.	Longitude E.	County Variation
Packington	South-west corner portion 7v, parish of Windah	23 35 29-6	149 59 38-6	8
Palmer	South-east corner section 1, town of Wyandra	27 15 04-3	145 58 42-7	6
Palmerston	North corner portion 6v, parish of Ewen, county of Lkable	22 39 29-3	150 18 21-0	8
Paluma	South-west corner portion 5, parish of Bowen Downs	22 32 58-7	144 53 25-4	6
Parker	Bayley Point	16 54 57	139 02 25	4
Paroo	North-west corner portion 1, parish of Bierbank	26 47 01-9	145 03 44-2	6
Pelham	West corner portion 32, parish of Scotia	24 31 09-7	150 34 43-1	8
Pender	Station 5 (G. 230.199) on rabbit fence, at north-west corner Ben Castle Block	26 39 53-0	141 23 56-4	5
Pera	Tree marked broad-arrow over RES over MD4, at north-west corner Meta Downs No. 4 Block	13 41 15	141 58 00	4
Raglan	North-west corner portion 28, parish of Annandale	24 05 03-5	150 28 03-3	8
Rawbelle	Station 54 (R.w. 309) on north-east boundary R. 68, parish of Rawbelle	25 01 44-4	150 50 38-3	8
Richmond	Richmond †	20 44 05-88	143 08 30-71	5
Rosedale	South-west corner Leadmore No. 5 Block, near tree marked broad-arrow over L5 over R12	20 45 26	139 10 15	4
Rodney	South-west corner portion 2v, parish of Collier	23 06 43-5	144 50 58-1	6
Rogers	Station 37 (Rg. 336) on west boundary portion 4, parish of Myall Grove	27 03 38-1	150 04 41-4	8
Roper	James Head Station	22 56 03	149 08 16	7
Rosebery	North corner Town Reserve, town of Birdsville	25 52 53	139 21 26	4
Rosebrook	South-west corner portion 6, parish of Matalma	23 08 42-6	142 15 29-1	5
Ross	South-east corner portion 1, parish of Onay	26 25 00-6	146 35 52-5	6
Ruppert	Richmond †	20 44 05-88	143 08 30-71	5
Ruthven	North-east corner portion 2, parish of Moonda	24 12 00-0	143 50 40-6	5
Rutledge	Station 22 (Ru. 1) on south boundary portion 1, parish of Mendip	22 35 13-5	147 04 36-9	6
Salisbury	Bobswaba Railway Station, at 47 miles 6:970 links	19 49 28-1	147 34 26-7	6
Sandringham	Sandringham Head Station	24 04 50	139 03 34	4
Savannah	North-west corner Malpas Holding, near tree marked broad-arrow over Z over XVII	19 32 28	142 08 49	5
Saxby	Station 220 (Sx. 7) in portion 1, parish of Blowpark	20 00 16-6	141 57 08-2	5
Selheim	Mount McConnell †	20 48 08-80	146 58 58-34	6
Selwyn	Malbon Railway Station, at 31 miles 7:234-5 links	21 04 26-7	140 17 59-3	4
Shelburne	Middle Peak	11 55 39	142 51 26	5
Sidmouth	Angle of Northern Telegraph Line, about 1 mile southerly from Stewart River	14 10 03	143 21 18	5
Solander	Port Douglas †	16 29 00-93	145 27 53-5	6
Somersset	Pateron †	10 48 11-8	142 23 44-4	4
Stanley	No. 1 State Bench Mark, Survey Office, Brisbane	27 28 28-6	153 01 29-6	9
Stokes	Tree marked broad-arrow over HP over B, at south-west corner Boongallet Block	18 15 36	140 38 04	4
Strathleven	North-east corner Strathleven Holding, at tree marked broad-arrow over T1 over P3	15 34 06	143 32 14	5
Strathmore	South corner Susatan River Holding, near tree marked broad-arrow over W over 21	17 05 10	142 24 50	5
Sturt	Tree marked broad-arrow over T over 4, at west corner Table-top No. 4 Block	23 39 14	138 22 14	4
Surrey	Croydon †	18 12 13-63	142 14 51-89	5

Talawanta	Tree marked broad-arrow over ND2 over D, at south-west corner Endymion Holding	18	23	08	140	11	00	4
Talbot	North-east corner R. 29, parish of Lilyvale	23	12	07-2	148	20	45-5	7
Taldora	Station 16a (Td. 12) on north boundary portion 2, parish of Merindee	19	14	29-3	141	21	23-7	4
Tambo	North corner portion 4, parish of Hawick	24	20	54-0	145	47	18-7	6
Tambar	Tree marked broad-arrow over C over 70, on Cooper's Creek, at north-west corner Keerongooloo Holding	25	48	44	142	11	47	5
Talc.	Mount Surprise Railway Station. Tangent point at 0.m. 7,233.4 links	18	08	47-5	144	18	58-5	5
Tevinga	Tree marked broad-arrow over ED1, on south boundary Cresfield No. 2 Block	19	45	20	139	48	20	4
Thunda	North-east corner portion 1, parish of Moothandella	25	31	33-4	143	06	00-0	5
Tingarra	Tree marked broad-arrow over A over XXI, on Arcadia Creek, in Arcadia Holding	25	14	48	148	48	30	7
Tinharoo	South-west corner Salsaire Block	28	39	47-7	143	21	20-0	6
Toko	Tree marked broad-arrow over L over 18, on Linda Creek, near west corner Idamea Lakes No. 11 Block	22	39	06	138	22	34	4
Tomoo	South-west corner portion 2, parish of Tongy	27	22	48-3	147	17	22-6	7
Toorak	Eulo Head Station	21	13	30	141	32	23	5
Torres	Thursday Island †	10	35	07-48	142	13	06-51	4
Towerhill	North-west corner portion 8v, parish of Eastfield	21	58	57-5	144	44	28-7	6
Ulanda	North-west corner portion 11v, parish of Midlothian	21	27	03-7	144	42	39-9	5
Ularunda	South-east corner portion 2, parish of Lomax	19	03	17-7	146	41	29-4	7
Undilia	Tree marked broad-arrow over R over XIV, on Thornton River, on north-west boundary R. 1, parish of Narah	19	21	58	138	50	51	4
Vergemont	Tree marked broad-arrow over K over XXX, on Vergemont Creek, near north boundary Vergemont No. 1 Block	23	50	12	143	08	46	5
Victor	Tree marked broad-arrow over G over XXVI, at junction Percy and Gilbert Rivers	19	08	25	143	28	04	5
Wairana	Crossing of Ingham road over Burdekin River, near Oakhills Head Station	18	32	36	145	35	48	6
Waldegrave	Roma †	26	34	31-32	148	47	05-04	7
Walker	South-east corner portion 2, parish of Aberfoyle	21	49	47-8	145	15	07-5	6
Walsh	Tree marked broad-arrow over N over XXXIX, at junction Brown Creek and Mitchell River	16	32	00	143	40	40	5
Warbreccan	North-west corner portion 16, parish of Chamsit	24	48	17-6	142	53	16-0	5
Warburton	Tree marked broad-arrow over C over XXIII, on south-east boundary Clarendon Holding	22	13	27	140	53	28	4
Ward	Mount Tamborine	27	55	13-03	153	09	37-46	9
Warner	South-east corner Kalkah No. 6 Block, at tree marked broad-arrow over K6	15	15	54	143	21	46	5
Watrong	South-west corner portion 6, parish of Ogilvie	25	22	00-6	147	59	26-7	7
Waverley	East corner portion 2, parish of Moonah	21	26	48-6	139	03	58-0	4
Weipa	Tree marked broad-arrow over B over XXVI, on Wenlock River	12	14	50	142	03	16	4
Wellestey	Sweers Island (Inscription Point)	17	06	56	139	35	40	4
Wellington	Eulo †	28	09	44-95	145	02	13-44	6
Wentworth	Tree marked broad-arrow over L over 11, on Lagoon Creek, near crossing of Darwin Road	17	20	50	138	16	58	4
Weramo	South-east corner Grayshall Block	25	26	40	138	26	36	4
Weringa	Remains of Ocoory Station, near Ocoory Waterhole on Gilmour Creek	25	14	49	139	33	32	4
Westgrove	North-east corner portion 21, parish of Simmie	25	41	31-2	148	40	56-7	4
Weymouth	Tree marked broad-arrow over BR over 1, at north-east corner Big River No. 1 Block, on Wenlock River	13	07	50	143	10	30	5
Wicklow	Hawkwood †	25	46	58-3	150	48	58-7	8
Wilkie Gray	North-east corner portion 304, parish of Argentine	19	20	08	146	10	55	6
Wills	Boulla †	22	54	45-43	139	54	24-44	4

TABLE OF COUNTIES, WITH THE COUNTY VARIATION AND INITIAL POINT FOR EACH—continued

County	Initial Point	Latitude S.	Longitude E.	County Variation
Wilson ..	Station 29 (G. 250,238) on rabbit fence, near tree marked broad-arrow over T over 24, on Dingera Creek, near south-east corner O'Hea Block	28 08 08.2	141 52 43.9	5
Windeyer ..	West corner portion 6, parish of Cathay ..	24 39 21.5	146 22 55.5	6
Windor ..	Noronside Station, at well ..	22 09 46	140 05 55	4
Windula ..	North-west corner portion 3, parish of Beilalle ..	26 58 55.7	142 46 44.0	5
Woodhouse ..	Nebo † ..	21 41 24.0	148 41 30.7	7
Wokingham ..	South-east corner R. 1, parish of Nuken ..	21 56 43.2	142 27 54.7	5
Wolseley ..	South-east corner portion 17, parish of Birmera ..	24 25 09.7	143 28 28.3	5
Wondoola ..	Donors Hill Head Station ..	18 42 40	140 33 20	4
Wongalle ..	Intersection north boundary portion 1, parish of Galah, and Prairie Creek ..	20 16 31.2	144 33 04.5	5
Wonomo ..	South-east corner Bernal Block, near tree marked broad-arrow over E over CXXI ..	20 08 15	138 21 54	4
Woodstock ..	North corner portion 10, parish of Eyernah ..	22 18 33.5	141 41 37.4	5
Woodgar ..	North-east corner Blacktown Block, near tree marked broad-arrow over B over 11 ..	19 45 14	143 00 28	5
Wooroolah ..	East corner portion IV, parish of Berriedale ..	24 59 18.8	145 21 19.2	6
Wooroona ..	Tree marked broad-arrow over S over 11, at Shorover Head Station ..	24 03 42	149 05 50	7
Woura ..	Iron pin, near north-east corner section 1, town of Prairie ..	20 52 22.3	144 35 58.1	5
Wrotham ..	Tree marked broad-arrow over G over MD, at north-east corner Wrotham Park Holding ..	16 29 16	144 08 40	5
Wyara ..	North-east corner Zenoni Block, at post marked broad-arrow over S ..	28 29 16	143 51 10	6
Yagoonya ..	Tree marked broad-arrow over 37, near junction Wyaabn Creek and Staaten River ..	16 26 52	141 34 18	4
Yappal ..	South-west corner portion 11, parish of Burligh ..	20 18 00.3	142 47 21.0	5
Yarrol ..	Station 10 (N1. 453) on north boundary portion 1, parish of Dalgaungal ..	25 06 23.4	151 19 48.7	8
York ..	Merlins Head Station ..	13 03 52.2	142 26 36.9	5
Youranigh ..	North-east corner portion IV, parish of Montes ..	23 54 09.4	145 01 31.2	6



Part C

Registration Requirements

C1
Registration of Individuals
as
Surveying Associates
Surveying Graduates
Surveyors

Endorsements

Reciprocity

C2
Registration of Bodies Corporate
as
Surveyors

Endorsements

C3
Renewal of Registration

Index

Part C1

Item	Section	Page
Registration of Individuals		
Associate	1.0	C1--1
Graduate	2.0	C1--1
Surveyor	3.0	C1--2
Practical Experience - Surveyor	4.0	C1--3
Licensed Surveyor	5.0	C1--3
Consulting Surveyor	6.0	C1--4
Insurance	7.0	C1--4
Professional Assessment Project	8.0	C1--5

Reciprocity

Reciprocal Registration	9.0	C1--5
Letter of Accreditation	9.1	C1--5
Applications and Fees	9.2	C1--6
Supporting Documentation	9.3	C1--6

Appendices

Statutory Declaration	-	C1--7
-----------------------------	---------	-------

Part C2

Registration of Bodies Corporate

Body Corporate	1.0	C2--1
Business Entity providing Survey Services	1.1	C2--1
Registration of Other Structures	1.2	C2--1
Business names	1.3	C2--2
Body Corporate Names	1.4	C2--2
Directors to be Registered Surveyors	1.5	C2--4
Insurance	1.6	C2--4
Branch Offices - Operation of	1.7	C2--5
Application for Initial Registration	1.8	C2--5

Part C3

Renewal of Registration

Annual Re-Registration	1.0	C3--1
Certification of Maintenance of Competence	2.0	C3--1

These guidelines should be read in conjunction with the relevant Sections of the Act and Regulation.

In September each year the Board sponsors a seminar on the requirements for registration and endorsement. Students and graduates should be aware of this seminar and attend at least one.

1.0 Associate

Section 38A (Act) -- Section 6 (Regulation)

1.1 Associate Diploma in Surveying or equivalent.

1.1.1 QIT, OR

1.1.2 USQ (DDIAE) Associate Diploma in Surveying 2 years full-time, 4 years external, OR

1.1.3 USQ Associate Degree in Surveying 2 years full-time, 4 years external, OR

1.1.4 Completed a course of study acceptable to the Board and is the holder of a diploma, certificate or other qualification conferred after due examination by an educational institution.

Plus 4 years approved practical experience in a field or fields of surveying which in the Board's opinion is appropriate for persons seeking registration.

1.2 A person is otherwise qualified if he/she has gained over a period of 7 years practical experience and competence in a field or fields of surveying which in the opinion of the Board is appropriate for persons seeking registration.

1.3 Further, the applicant must satisfy the Board as to his/her capacity to maintain a high level of performance in the technical aspects of the practice of surveying.

1.4 An application shall be on Form 1 and be accompanied by the prescribed fee.

2.0 Graduate

Section 38 (Act) -- Section 7 (Regulation)

2.1 Degree in Surveying or equivalent.

2.1.1 U of Q Bachelor of Surveying, 4 years full-time, OR

2.1.2 QUT/QIT Bachelor of Applied Science (Surveying), 3 years full-time or part-time equivalent, OR

2.1.3 QUT Bachelor of Surveying, 4 years full-time or part-time equivalent, OR

2.1.4 USQ Bachelor of Technology (Surveying) 3 years full-time, 6 years external, OR

2.1.5 USQ Bachelor of Surveying, 8 years external, OR

2.1.6 Appropriate qualifications from a tertiary education institution recognised under the reciprocating Boards arrangements within Australia and New Zealand.

2.2 An applicant shall complete Form 2 and such application shall be accompanied by the prescribed fee.

3.0 Surveyor

Section 37 (Act) -- Section 8 (Regulation)

3.1 Academic Qualifications

3.1.1 Holds a degree in Surveying as set out in 2.1, and shall:-

3.1.2 have gained practical experience in surveying and satisfactorily completed a Professional Training Agreement (refer to 8.0 PAP), sufficient to satisfy the Board of his/her capacity to maintain a high level of performance in all aspects (ethical, administrative & technical) of the practice of surveying,
OR

3.1.3 have gained the Graduate Diploma in Surveying Practice from QUT,
OR

3.2 Higher Qualifications

3.2.1 satisfy the Board that he/she possesses academic qualifications that the Board considers to be higher than the academic qualifications referred to in 3.1.1; and

3.2.2 satisfy the Board that he/she has gained practical experience that the Board considers to be equal to or greater than the requirements referred to in Requirements 3.1.2 or 3.1.3 above;
OR

3.3 Reciprocity

3.3.1 satisfy the Board that he/she is registered as a surveyor with the Surveyors Board or other competent authority of a State or Territory of Australia, or of New Zealand, or that he/she is entitled to be so registered; and

3.3.2 if required by the Board, pass such examinations (whether written or oral or both), and gain such practical experience or additional practical experience and do such additional projects, as the Board considers to be sufficient for the purpose of qualifying him/her to be registered under the Act.

3.4 Application

An applicant shall complete Form 3 and such application shall be accompanied by the prescribed fee.

4.0 Practical Experience - Surveyor

Section 37(1)(b)(i)(B) (Act)

- 4.1** Prior to making application to the Board for registration as a surveyor, every surveying graduate shall have gained a period of two years practical experience under the supervision of a registered surveyor or in the case of cadastral surveying a licensed surveyor.
- 4.2** The surveyor supervising the practical experience being undertaken by a surveying graduate shall report thereon to the Board in Form 6, at the end of each period of experience or at the end of each six months, whichever is the lesser period.
- 4.3** The Board may accept the practical experience gained by a surveying graduate or student or it may refuse to accept the whole or any part of the experience if the Board is of the opinion that such experience is in any respect unsatisfactory.
- 4.4** The Board may grant credit of up to the two years practical experience required. Each case will be considered on its merits.
- 4.5** The minimum requirements for practical experience shall be a period of at least six months in urban and six months in rural cadastral surveying and at least six months in engineering and six months in another discipline of surveying.

5.0 Licensed Surveyor

Section 42 (Act) -- Section 9 (Regulation)

- 5.1** A person registered as a surveyor or an applicant for registration as a surveyor who seeks to have his/her registration in the Register of Surveyors endorsed to the effect that he/she may perform cadastral surveys shall
- 5.1.1** satisfy the Board that he/she has completed a period of twelve months practical experience in cadastral surveying as set out hereunder.
- The practical experience shall:-
- (i) be performed under the supervision of a licensed surveyor; and
 - (ii) relate to cadastral surveying in both urban and rural areas; and
 - (iii) include a Professional Assessment Project in cadastral surveying; and
 - (iv) have been gained under a Professional Training Agreement;
- OR
- 5.2** have gained the Graduate Diploma in Surveying Practice from QUT;
- OR

5.3 satisfy the Board that he/she is licensed or otherwise authorised by the Surveyors Board or other competent authority of a State or Territory of Australia, or of New Zealand, to perform cadastral surveys; and

5.3.1 an applicant shall complete Form 4 and such application shall be accompanied by the prescribed fee.

6.0 Consulting Surveyor

Section 42A (Act) -- Section 10 (Regulation)

6.1 A person registered as a surveyor or an applicant for registration as a surveyor who seeks to have his/her registration in the Register of Surveyors endorsed to the effect that he/she is a consulting surveyor shall satisfy the Board that he/she intends to provide survey services to the public for a fee, and

6.2 have completed the Graduate Diploma in Surveying Practice under a Professional Training Agreement incorporating at least, 5 core units, Professional Practice Management 2 and 2 other elective units;
OR

6.3 have completed a Professional Training Agreement incorporating at least five core units plus Advanced Professional Practice Management and two other elective units; OR

6.4 have completed the Board's practical experience requirements and obtained a satisfactory assessment result from the Association of Consulting Surveyors Queensland;
OR

6.5 have satisfactorily completed his/her assessment under a Professional Training Agreement incorporating, at least, 5 core modules plus Property Development Surveys, Advanced Professional Practice Management, one other optional module, and a Professional Assessment Project in an approved field with an emphasis on consulting activities, before an application for endorsement as a consulting surveyor will be considered.

6.6 An applicant shall complete Form 5 and such application shall be accompanied by the prescribed fee.

7.0 Insurances

Section 42A (Act) -- Section 10(2) (Regulation)

An applicant for endorsement as a consulting surveyor shall take out and maintain professional indemnity insurance and public liability insurance cover to minimum values as set by the Board from time to time, prior to making application to the Board for the Consulting endorsement. The minimum values are shown on the forms for initial application and for registration renewal. (Refer SOM Web Site www.qld-som.com.au).

8.0 Professional Assessment Project (PAP)

- 8.1** Prior to making application to the Board for registration as a surveyor, a surveying graduate shall complete, to the Board's satisfaction, a Professional Assessment Project (PAP).
- 8.2** The Board may accept a project undertaken by an honours or post-graduate student during the course of his/her higher studies, in lieu of the PAP.
- 8.3** The Professional Assessment Project shall be of moderate complexity, and sufficiently broad for the surveying graduate to adequately demonstrate his/her competence and professionalism (ethical, technical and administrative) in the broad practice of surveying.
- 8.4** The surveying graduate shall, prior to commencing work thereon, apply to the Board on Form 8 for approval of the proposed project. Such application shall be accompanied by the prescribed fee.
- 8.5** The Board shall appoint an examiner and an assistant examiner. If the project is one in the category of cadastral surveying, both examiner and assistant examiner shall be licensed surveyors.
- 8.6** Both examiner and assistant examiner shall assess the competence of the surveying graduate by observing his/her performance of the project, and shall conduct such oral or practical examinations as they deem necessary.
- 8.7** The Board may conduct such further oral or practical examination as recommended by the examiner or as the Board sees fit, either in the category of surveying chosen in the PAP or in other categories of surveying.

Reciprocity

9.0 Reciprocal Registration - Section 37(b) (Act) -- Section 8(3)(c) (Regulation)

For registration in Queensland as a surveyor, of a person currently registered in another State or Territory of Australia or in New Zealand, the applicant has to submit the following:

9.1 Letter of Accreditation

A Letter of Accreditation from the Surveyors Board with whom they are currently registered.

An application form for a Letter of Accreditation is available from the Surveyors Board with whom they are currently registered.

9.2 Applications and Fees

Written application on the prescribed forms:

- Form 3 - Application for Registration as a surveyor; and

where the applicant seeks endorsement to perform cadastral surveys:

- Form 4 - Application for Endorsement to Perform Cadastral Surveys, with suitable evidence of cadastral surveying practical experience to support the application, and

where the applicant intends to provide survey services to the public for a fee:

- Form 5 - Application for Endorsement as a consulting surveyor, with evidence of practical experience considered suitable by the Board;

plus

- the prescribed fees.

9.3 Supporting Documentation

The following documentation is required to accompany the applications :

- two (2) recent (dated within the last twelve months) references to the applicants good fame and character,
- a completed Statutory Declaration in the form attached hereto, and
- a certified statement that the applicant has studied:
 - the Surveyors Act 1977;
 - the Surveyors Regulation 1992;
 - the Survey Co-ordination Act 1952;
 - the Surveyors Operations Manual;
 - "Law Related to Land Boundaries and Surveying" by A G Brown; and
 - the legislation contained in the list set out in Part B - General Information; AND
- where the applicant is seeking endorsement as a consulting surveyor, evidence that the applicant holds the professional indemnity and public liability insurances required under Section 10(2) of the Surveyors Regulation 1992.
- The applicant is required to submit to the Board a copy of their proposed letterhead and invoices for the Board's approval.

SURVEYORS ACT, 1977
STATUTORY DECLARATION

I, _____ do here by solemnly and sincerely declare that I will, to the best of my ability and without partiality, favour or affection, correctly survey and delineate the boundaries of any land I may be instructed to survey, in strict compliance with the Surveyors Act 1977 the Surveyors Regulation 1992 and Directions in force for the time being of the Board constituted by the Surveyors Act 1977, and set out in the Surveyors Operations Manual.

(Signed)

Taken and declared before me, at _____ this _____ day of
_____ 19 _____

(Signed)
A Justice of the Peace/
Commissioner for Declarations

This page intentionally left blank.

1.0 Body Corporate -

Section 40 (Act) - Section 11 (Regulation)

1.1 Business Entity Providing Survey Services

A business entity which presents itself to the public as being a surveyor or in the business of providing survey services is required to be registered with the Board. The Board considers that the business entity which presents itself to the public is one and the same as the entity which is registered and/or licensed.

1.1.1 A body corporate is to be registered as a surveyor if it includes the name of a registered surveyor or words descriptive of the practice of surveying; and is a name which the Board considers desirable in relation to the practice of surveying.

1.1.2 Any registered person being an individual, may practise under his/her own name with suitable designation eg, licensed surveyor or consulting surveyor.

1.1.3 Any registered person being a body corporate may practise under the name of that body corporate, or under another name approved by the Board. This applies to:

- a sole practitioner who, for business reasons, is the employee of his own private trading company, which company has been registered with the Board; and
- a company which wishes to use a business name of which it is the beneficial owner. It is a requirement that the name of the beneficial owner(s) of any business name, must be shown on all relevant stationery. Further, the names, qualifications and designations of the principals and/or directors of that entity must be shown. Where there are only two directors, one of whom is the spouse of the registered person (sole practitioner), the name of the registered person only is to be shown.

1.1.4 In Summary

- The name of the entity must reflect the composition of that entity.
- The name of the beneficial owner(s) of the business name, if one is used, must be shown on all stationery.
- The name and registered status of the registered person(s), principals and directors of the body corporate must be shown on all stationery.

1.2 Registration of Other Structures

1.2.1 Partnerships etc

The present legislation does not allow the Board to register Partnerships, Public companies limited by shares and Government organisations offering surveying services.

1.2.2 Trusts

The Board has determined that for the public interest to be upheld, a prospective client should be able to readily ascertain the entity or individual with whom he/she is dealing in relation to surveys.

The manner in which trusts can be set up, does not provide this "open" view of the entity. To this end, the Board does not register Trusts.

1.3 Business Names

The Surveyors Act 1977 at Section 47 provides for certain penalties for a person who holds out as a surveyor unless the person is registered as a surveyor under the Act. The section also prohibits the use of the words "registered", "licensed", "consulting", "consultant" in connection with the word "surveyor", unless the person is licensed or registered under the Act.

Section 47A of the Act provides for the steps to be taken by a person intending to practice surveying under a business name.

The Acts Interpretation Act 1954 provides the following meaning-
"Person" or "Party" - Includes a body corporate.

Further, the Act provides that every word in the singular number shall be construed as including the plural number, unless contrary intention appears.

1.4 Body Corporate Names - Approval, Content, Stationery

1.4.1 The body corporate must apply to the Board for prior approval of the proposed name and letterhead before making application for registration as a surveyor.

The following items should be adhered to in a name:-

- a company name should preferably only contain names of registered persons,
- stationery shall only show the names of registered persons. The appropriate category of registration shall, and qualification(s) may, be shown against each name,
- the name of a person who is holder of another qualification, may be shown on a letterhead, provided, the persons designation within the practice is also shown,
- a company (or business) name shall not include the term "and Associates" unless registered persons are actually carrying out such functions.

1.4.2 A body corporate name cannot include:-

- the name of a person who is not registered with the Board,
- Surveyor(s) in the name or in association with Registered, Licensed, Consulting, or Consultant, or
- the name of a Partnership or Trust.

For Example:

Acceptable	Unacceptable
Thompson Surveys Pty Ltd	W A Thompson & Partners Pty Ltd
Teerink & Thompson Pty Ltd (where both are registered persons)	Thompson Family Trust
W A Thompson Pty Ltd (Trading as Thompson Surveys)	Thompson & Thompson Surveys Pty Ltd (where one is a register surveyor and their spouse, who is not a registered person)
W A Thompson & Associates Pty Ltd (& Associates is acceptable only where there are in fact Associates.	Thompson Surveying Pty Ltd
Brisbane Survey Services Pty Ltd	W A Thompson Consulting Surveyor/s Pty Ltd
Survey and Mapping Services Pty Ltd	W A Thompson Registered Surveyor/s Pty Ltd
	W A Thompson Licensed Surveyor/s Pty Ltd
	W A Thompson Surveyor/s Pty Ltd

1.4.3 The Letterhead of a body corporate is to include:-

- the body corporate name, the Australian Securities Commission ACN and address, and if operating under a "trading" name, both the body corporate name and trading name must be clearly shown,
- the names and qualifications of all directors who are registered persons or hold qualifications acceptable to the Board.

1.4.4 The names of unregistered persons who do not hold qualifications acceptable to the Board cannot be shown.

For example:

THOMPSON SURVEYS PTY LTD
ACN 012 345 678
trading as
SOUTH QUEENSLAND SURVEYS

Consulting Surveyors

Shop 4, Land Centre, Woolloongabba. Qld 4102 Telephone 07 987 6543

Principals: W A Thompson L.S., B App Sc (Surv), M.L.S Aust
D M Thompson L.S., B App Sc (Surv),
I F Mudd, B. Cart,(Hons)

1.5 Directors to be Registered Surveyors

A majority of the directors of the body corporate must be registered surveyors or where there are only two directors at least one must be a registered surveyor. The registered surveyor(s) director(s) must hold a majority of the voting rights.

1.5.1 Where the body corporate intends to engage in cadastral surveys the registration is to be endorsed to that effect and the majority of directors must be licensed surveyors or where there is only two directors, the principal beneficiary must be a licensed surveyor.

1.5.2 A body corporate shall not practice or hold itself out as a consulting surveyor unless each of its directors who is a registered surveyor is endorsed to the effect that he/she is a consulting surveyor.

1.5.3 Where a body corporate has only two directors and one of these directors is not a surveyor, that director shall submit a letter stating that in the event of the registered surveyor director no longer being able to carry out the survey functions from whatever causes, that he/she will take immediate steps to have the registered surveyor replaced with another suitably qualified director.

1.5.3.1

Sample letter:

To: The Secretary
Surveyors Board of Queensland
PO Box 810
SPRING HILL QLD 4004

Dear Secretary,

I, *(name of non-surveyor director)*, being a non-surveyor director of *(name of body corporate)* which has only two directors, hereby give my undertaking that I will take immediate steps to have registered surveyor director, *(name of surveyor director)*, replaced with another suitably qualified surveyor director in the event of *(name of surveyor director)* being no longer able to carry the survey functions from whatever causes.

(signature of non-surveyor director)

1.6 Insurance

The body corporate must hold current professional indemnity and public liability insurances to minimum values set by the Board (See Sect. 7.0 in C1).

1.7 Branch Offices - Operation of

Section 11 of the *Surveyors Regulation 1992* states:

'Registration of body corporate'

11. The Board may register, or renew the registration of a body corporate as a surveyor if -

- (d) *the business of the body corporate at each place of business in the State is personally supervised and managed by a registered surveyor;*

The public would also reasonably expect that the person representing the body corporate with whom they are dealing, is a professional person appropriately registered and endorsed.

1.8 Application for Initial Registration

Application for registration of the body corporate is to include:

- Form 3 - Application for Registration as a surveyor; and
- Form 4 - Application for Endorsement to Perform Cadastral Surveys; and
- Form 5 - Application for Endorsement as a Consulting surveyor and;
- the prescribed fees; and
- Form 10 - Application for Registration as a surveyor by a body corporate - Solicitors Certificate; and
- A list of current directors and their qualifications; and
- Evidence of the Professional Indemnity Insurance and the Public Liability Insurance and to the currency thereof; and
- a copy of the certificate of registration of the company, or business name.

Form 4 and the associated fee is not required if the body corporate will not be engaged in and does not intend to engage in cadastral surveys.

This page intentionally left blank.

1.0 Annual Re-Registration

The Surveyors Act 1977 at Section 41 provides for renewal of a person's registration. The re-registration period is set between 1 October and 30 November each year.

The Board will assist registered persons by posting a renewal notice to them at the address shown on the register by 30 September. The notice will set out the fee due and list the requirements for re-registration in each year.

Where a registration has not been renewed by 30 November, a late notice shall be posted by 15 December. This notice will set out the fees due, including the late lodgement fee.

When a registered person has not paid the required fees by close of business on 31 December, the name of that person shall be removed from the register.

Restoration of a name to the register shall occur on receipt of all fees and costs including the late registration and restoration fees.

1.1 Late and Restoration Fees

The Section 41(3) fee (the Late Fee), is charged for renewal of registration in cases where renewal has not been applied and paid for by 30 November in each year and/or application for renewal is made within the 12 month period following the lapse of registration.

- 1.1.1 The Restoration Fee is charged in such instances where registration has been allowed to lapse or where registration has been cancelled by the Board and application is being made to be restored to the register; OR

an application for restoration is made within a period of not greater than 2 years after the lapse of registration.

- 1.1.2 A Restoration Fee is charged in addition to the prescribed Registration Fee and Late Fee.

- 1.1.3 If registration has been allowed to lapse and more than 2 years pass before restoration is sought, new applications for registration must be submitted.

Applicants may be requested to satisfy the Board that they are competent at the time of application.

2.0 Certification to Maintenance of Competence

Section 41(1) of the Act sets out that a person's registration may be renewed by the Board "as long as the person so registered continues to be qualified to be so registered...".

To become registered as a surveyor in Queensland, a person must satisfy the Board of his/her capacity to maintain a high level of performance in all aspects (ethical, administrative and technical) of the practice of surveying.

Each year, at the time of re-application for registration, the registered person must satisfy the Board that he/she has maintained his/her competence in the practice of surveying.

It is the Board's opinion that to maintain competence, a registered person should undertake relevant professional development on an ongoing basis. This may be by attendance at seminars, workshops, in-house training, pursuit of formal tertiary qualifications, non-award courses, research, active participation in professional body groups, reading of journals and publications relevant to surveying and so on.

All surveyors are asked to answer the following statement on their Renewal Application each year.

I certify that I maintained my competence during 1998 in the level of registration for which I apply for renewal.

__/__/__.

The Board will not require substantiation of maintenance of competence at the time of application for renewal of registration. However, it is recommended that registered persons keep adequate records of his/her professional development activities during each year.



Part D

Education, Training and Practical Experience

D1

Professional Training Agreements
and
Graduate Diploma in Surveying
Practice

D2

Specifications for
Professional Assessment Projects
and
Guidelines for Examiners

Index

Part D1

Item	Section	Page
------	---------	------

Education, Training and Practical Experience

Introduction

Introduction	1.0	D1-1
--------------------	-----------	------

Professional Training Agreements

Introduction	2.1	D1-1
--------------------	-----------	------

Graduate Diploma in Surveying Practice

Entry Requirements	3.1	D1-2
Course Objectives	3.2	D1-3
Course Structure	3.3	D1-3
Project Work	3.4	D1-4
Text and Reference Books	3.5	D1-4
Further Information	3.6	D1-4

Part D2

Professional Assessment Project

Specification

Introduction	1.0	D2-1
Board Philosophy on the PAP	2.0	D2-1
Examiners	3.0	D2-2
Application to Proceed	4.0	D2-2
Report Content	5.0	D2-2
Examiner's Report	6.0	D2-3

Guidelines for Examination

Assessment	7.0	D2-3
Checklist	8.0	D2-4
Professional Aspects	9.0	D2-4
Report of the Examiner	10.0	D2-5

1.0 Introduction

One of the responsibilities of the Surveyors Board is to assess the competence and suitability of candidates for registration as a surveyor and attaching endorsements.

As part of this process, candidates are required to either:

- satisfactorily undertake the Graduate Diploma in Surveying Practice (the SPC), or
- to complete a Professional Training Agreement (PTA) and a Professional Assessment Project (PAP); or
- a mix and match of the SPC, a PTA and a Professional Assessment Project (PAP).

2.0 Professional Training Agreements

2.1 Introduction

The Board introduced Professional Training Agreements (PTAs) from 1 January, 1998. The PTA replaced the technical projects system.

2.1.1 Purpose

The purpose of the PTA is to provide a structured training programme, to assist a registered surveying graduate with the overall continuing education, training and development of skills. This includes a suitable programme of technical and professional activities. A range of core activities are essential competencies needed by all professional surveyors seeking general registration.

These core competencies should be capable of being provided in almost any type of survey practice.

Competency areas would then be identified to cover endorsements to perform specialised surveys, eg cadastral, engineering surveys and so on.

The registered surveying graduate should be provided with opportunities to progress education, training and skills development, through training and resources provided by supervising surveyors.

The PTA will directly involve the applicant, a supervising surveyor, and the Surveyors Board of Queensland. Where the applicant is undertaking the Graduate Diploma in Surveying Practice, the Queensland University of Technology is also a party to the PTA. The applicant must have an approved degree in surveying and the equivalent of twelve months of approved experience, preferably post graduate, prior to entering into a PTA.

The PTA is able to be transferred between supervising surveyors, subject to certain conditions and approval of the Board.

2.1.2 Flexibility

Flexibility in the choice of optional modules will be available within the PTA. The overall intent will be the provision of education and training to develop a well rounded professional surveyor. The flexible structure of the PTA will provide clear benefits to the applicant. The PTA, through this flexible content, is capable of both innovation and versatility.

Professional Training Agreements (PTA) were adopted in principle by the Conference of the Surveyors Boards of Australia and New Zealand in November, 1996. PTAs provide a mechanism to enable a person, competent in surveying at Stage 1 as set out in the National Competency Standards for Professional Surveyors, (NCSFPS), to progress to registration as a surveyor in Australia and New Zealand.

2.1.3 Professional Training Agreement Information Kit

Interested persons with an approved degree in surveying and the equivalent of twelve months approved experience, who wish to progress towards registration as a surveyor and obtain specialist endorsements, can contact the Board in relation to a PTA information kit.

2.2 Discussion with Candidates Approaching Registration

It is the policy of the Board for candidates, who are approaching registration, to meet with the Registration Committee. It is the intention to have a discussion with all candidates who have substantially completed their Professional Training Agreement.

The graduate is at the stage where he/she has satisfied the education and training requirements of the Board and this discussion should now determine the individuals attitude, administrative capacity and ethical outlook to the profession of surveying.

As it is not practical to have country based candidates come to Brisbane for these discussions, the Board has agreed that where appropriate, a discussion be held with the candidate in a country centre by two Board members, or one Board member and a local surveyor, or two local surveyors. These discussions are arranged through the Board's Secretary.

3.0 Graduate Diploma in Surveying Practice

3.1 Entry Requirements

3.1.1 Normal Entry

To be eligible to enrol in the course leading to the Graduate Diploma in Surveying Practice (SPC), an applicant shall hold:

- (a) a Bachelor of Surveying from the University of Queensland;
- OR**
- (b) a Bachelor of Applied Science (Surveying) from the Queensland University of Technology (QUT);
- OR**
- (c) a Bachelor of Surveying from (QUT);
- OR**
- (e) a Bachelor of Surveying from (USQ);
- OR**
- (f) a degree from another tertiary institution considered by the Surveyors Board of Queensland to be at least equivalent to the degrees named above.

3.1.2 Qualifying entry

Applicants who do not meet the requirements for normal entry but who hold a tertiary qualification in a technological field or other equivalent qualification may be required to complete such pre-requisite surveying and other subjects as may be determined by the Head of School of Surveying prior to enrolment in the course.

3.1.3 Prior Practical Experience

At least one year approved field experience in the practice of surveying is required prior to entry into the Survey Practice Course.

3.2 Course Objectives

- To provide surveying graduates with a period of intensive education and training so that they will reach the standard of competence required for registration and endorsement by the Surveyors Board of Queensland;
- To impart practical skills in surveying procedures and develop the ability to apply them without difficulty;
- To assist students to recognise their own limitations and make use of other professions when appropriate;
- To enhance the ability to communicate effectively

3.3 Course Structure

The course builds on the completion of an approved degree in surveying augmented at least one years approved field experience in the practice of surveying. Therefore the course is pitched at the post-graduate level pursuing a holistic approach to surveying projects including aspects of logistics, management, technology, quality assurance and resources.

The course requires completion of eight units, made up of 5 core units and electives chosen on the basis of endorsements being sought. Each unit is offered in a compressed time frame requiring attendance for approximately two weeks at QUT for each unit.

The 5 core units and available electives are:

Semester 1	Semester 2
<p><u>Core Units:</u> Professional Practice Management 1 Boundary Definition Surveys 1 Survey Computing & Processing</p> <p><u>Electives:</u> Property Development Surveys Urban Drainage Other approved electives</p>	<p><u>Core Units:</u> Project Site Surveys GIS and GPS</p> <p><u>Electives:</u> Engineering Surveying Boundary Definition Surveys 2 Professional Practice Management 2 Other approved electives</p>

3.4 Project Work

Each unit includes project work that can be made up of field work, assignments, reports and examinations. The lecture/tutorial material and the project work are mutually supportive of the learning process. The field work will be done away from QUT preferably in a work environment. Similarly reports, assignments etc., will be done as private study. Examinations and supervised tutorials will be part of the contact time at QUT.

3.5 Text and Reference Books

Lecture Notes and Practice Papers, prepared specifically for the course by the profession, are made available to the students at cost price.

Students are required to purchase copies of certain statutes, texts and the Surveyors Operations Manual making up the basis of their professional library. (These are recommended by the practising surveyors, who include reference texts in lecture notes where applicable.)

3.6 Further information

Further information can be obtained from:

**The Course Administrator, Survey Practice Course
 School of Surveying
 QUT - Gardens Point Campus
 GPO Box 2434 (2 George Street)
 BRISBANE 4001
 Telephone: (07) 3864 2804/3 Fax No: (07) 38641809**

Professional Assessment Project

1.0 Introduction

A Professional Assessment Project may be undertaken in any category of surveying. A person seeking to become a licensed surveyor is required by the Surveyors Regulation Section 9 to undertake the project in cadastral surveying. The project should embrace work undertaken in the normal course of business of the firm or authority in which the applicant is employed.

2.0 Board Philosophy on the Professional Assessment Project

The purpose of the Professional Assessment Project is to make a final check on the fitness of the candidate for registration. The Board has from time to time adopted certain views on how it may be used for this purpose. The candidate has already demonstrated technical ability by completing the Professional Training Agreement. The PTA is considered to constitute a demonstration at a reasonable (not specialist) level of the persons' ability.

The administrative ability is assessed by the way the Examiners see the candidate's performance in discussion and negotiation. If the project is within the public sector, similar negotiations would be assessed with respect to the client department. These examples are not exhaustive but provided there is a significant administrative input, an assessment can be made.

The Board demands continued technical ability - hence it needs some field survey in the Professional Assessment Project, but not necessarily as demanding as that in the Professional Training Agreement.

Sometimes the negotiating process breaks down at an advanced stage and the candidate may feel a need to start again on a new project. This is not so. If, for example, the process stops due to unwillingness of the clients to accept Council conditions, the Examiners can proceed from that point by discussing with the candidate what the candidate's advice would be and how he/she would proceed with an appeal or whatever the succeeding steps might be. The Examiner, could if necessary, observe the candidate in the field on another job to assess the field aspect.

The Board's attitude is that provided it can be satisfied under Section 37 of the *Surveyors Act 1977* by the candidate through advice from the Examiners, it should allow the process to be as smooth as practicable.

The Board also considers that by the time the candidate is presenting a Professional Assessment Project, the candidate should have a good understanding of their role and responsibility in the community and in relation to their fellow professionals; Examiners may well initiate discussion on this and other aspects of professionalism.

3.0 Examiners

- 3.1** The Board shall appoint an Examiner and an Assistant Examiner. If the project is one in the category of cadastral surveying, both Examiner and Assistant Examiner shall be Licensed Surveyors. The Assistant Examiner shall, whenever possible, be the surveyor who supervises the applicant in his normal place of work.
- 3.2** The Examiner, Assistant Examiner and applicant shall consult together to plan the project. The Assistant Examiner shall observe the performance of the applicant, each day if possible. The Examiner shall consult with the Assistant Examiner and observe the performance of the applicant, each week if possible.

4.0 Application to Proceed

- 4.1** Before submitting his/her 'Application for Approval of a Proposed Professional Assessment Project' (Form 8), the applicant shall, in consultation with the Assistant Examiner, make all arrangements necessary for the performance of the project.
- 4.2** The applicant shall describe on Form 8 the nature of the project proposed, giving a brief description of the category of surveying to be undertaken, the objectives of the project and the methods to be adopted to achieve the objectives, details of the candidates involvement in the project, the locality of the survey, a cost estimate, a project timeframe, and shall nominate the Assistant Examiner.
- 4.3** The Assistant Examiner proposed by the applicant shall support the application with a statement of his intention to perform the necessary supervision of the project.
- 4.4** The Board shall appoint the external Examiner.

5.0 Report Content

The candidate in the performance of the project, should consider the ethical, administrative and technical aspects and report on the following:

- the discussions which determine the objectives of the project,
- in planning of the work,
- obtain all consents necessary,
- make a full search of relevant existing data,
- personally perform the surveys and calculations,
- supervise the drawing of plans or maps,
- prepare a costing statement,
- arrange lodgement of the results of the project,
- and submit a report to the Examiner on each of the above actions.

6.0 Examiners Reports

- 6.1 The Assistant Examiner shall report to the Examiner on the performance of the applicant throughout the project and on the candidate's ethical, administrative and technical performance aspects as these pertain to the project.
- 6.2 On completion of the project, the Examiner shall report on the performance of the applicant and recommend whether the Board should accept the project.
- 6.3 The Examiner's and Assistant Examiner's report **MUST** include:
- a recommendation whether the candidate should be awarded a pass for the project;
 - a statement on whether the candidate has shown competence and professionalism; and
 - a recommendation on the suitability of the candidate for registration as a surveyor and if appropriate, licensing.

Guidelines for Examination

7.0 Assessment

- 7.1 The attention of the Examiners is drawn to the following and in particular to the provisions for the conduct of an oral or practical examination.
- 7.1.1 Both Examiner and Assistant Examiner shall assess the competence of the surveying graduate by observing the candidate's performance on the project and shall conduct such oral or practical examinations as they deem necessary.
- 7.1.2 The Board may conduct such further oral or practical examination as recommended by the Examiner or as the Board sees fit, either in the category of surveying chosen for the PAP or in other categories of surveying.
- 7.2 The Examiner and Assistant Examiner shall take into consideration the check list set out hereunder.

The check list refers specifically to a cadastral project. A number of its headings will apply equally to a project in some other branch of surveying, others will not. The Examiner of the latter type project will need to take this into account. The Examiner may see fit to introduce alternative components to meet particular requirements.

The check list is to be regarded as a guide and should not be converted into a quantitative marking scheme by the allocation of marks to the components or sub-components.

8.0 Checklist

8.1 Objectives

Discussions with client; identification of purpose of the survey; completion date to meet clients needs.

8.2 Planning

Instruments and other equipment; personnel; travelling and accommodation; notice of entry; time schedule; cost estimate; ascertain the relevant land tenure, encumbrances, reservations, etc.; administrative process adopted.

8.3 Approvals

Correspondence and discussion with client and planning authority and/or the Department of Natural Resources on consent matters such as zoning. The assessment of conditions of approval and their relevance.

8.4 Search

Location map; search of Department of Natural Resources and Department of Mines and Energy documentation (plans, field notes, PSM sketches, proclaimed survey area data, etc.).

8.5 Field Work and Calculations

Datum; reinstatement; field procedures; meridian; marking; survey records; calculations; report on field survey.

8.6 Plan

Supervision of draftsman; compliance with Survey Plan Guidelines; suitability for proposed action.

8.7 Costing Statement

Charge out rates in accordance with contractual arrangements, explanation of unforeseen costs.

8.8 Lodgement of Results

Endorsement of plan by surveyor, registered proprietor, Local Authority, Chief Executive - Department of Natural Resources (if required), lodgement of plan and any other supporting documents with the registering authority.

9.0 Professional Aspects

The candidate's professional approach to the project in terms of compliance with the code of professional conduct and relationships with the client, statutory bodies and other professionals.

10.0 Report of the Examiner

As the Board's eyes and ears, the Examiner and the Assistant Examiner offer judgements and opinions on the candidate's performance. This is so that (in the words of Section 37 of the Act) the candidate can "Satisfy the Board of his capacity to maintain a high level of performance in all aspects (ethical, administrative and technical) of the practice of surveying."

In order to be "satisfied" the Board seeks from the Examiners a full report which, as well as commenting on the points listed, discloses all doubts or deficiencies about the candidate's performance and offers opinions on any matter connected with the project or resulting from discussions with the candidate.

The Examiner is required to conclude the report with a recommendation on whether the candidate, in the Examiner's opinion, has shown competence and professionalism. The examiner recommends on whether the candidate is fit to be registered as a surveyor and endorsed as a licensed surveyor.

So as not to disadvantage candidates and to allow the Board sufficient time to digest their reports properly, Examiners are requested to submit their reports on the project at least ten (10) days before a Board meeting.

This page intentionally left blank.

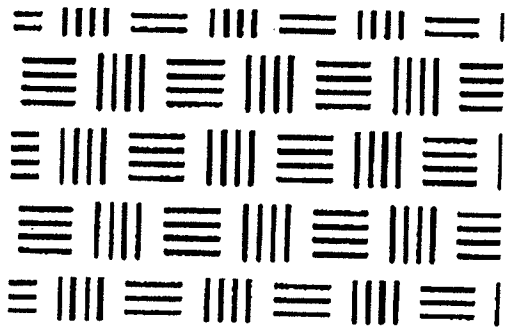

Part E

Standards for Surveys

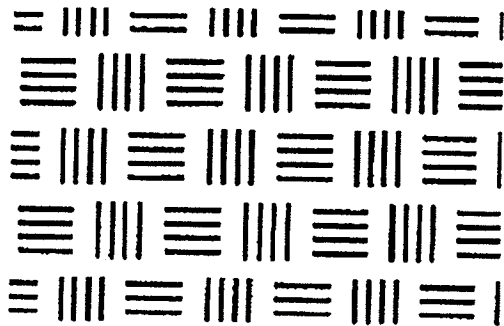

E1
**Directions and Recommended
Practices for Surveyors
to assist surveyors in the
performance of their work**

E2
Survey Plan Guidelines - General

E3
Dept. of Natural Resources - Requirements

E4
Dept. of Mines & Energy - Requirements

E5
Dept of Main Roads - Requirements



This page intentionally left blank.

Index Part E1

Item	Section	Page
Introduction		
Legislation	1.0	2
Authority for Directions	2.0	2
Review	3.0	2
Departure from Directions	4.0	3
Definitions	5.0	3
Directions		
Survey Plans	1.0	4
Stakings	2.0	5
Long Line Easements	3.0	6
Recommended Practices		
Introduction	101.0	9
Review	101.2	9
Departure from Recommended Practices	101.3	9
Supervision	102.0	9
Connection of Surveys	103.0	10
Encroachment	104.0	10
Meridian Determination	105.0	11
Australian Map Grid	105.1	11
Integration of Surveys	105.2	11
Large Projects	105.3	12
Professional Responsibility	105.4	12
Extensive Surveys	105.5	12
Future Reinstatement of Meridian	105.6	12
Survey in Separate Parts	105.7	12
Permanent Marks	106.0	12
Marking Boundaries	107.0	13
Reference Marking	108.0	14
Iron Pin	108.1	14
Rural Areas	108.2	14
Urban Areas	108.3	14
Estate Development	108.4	14
Photogrammetric Surveys	109.0	14
Location Certificates	110.0	15

Introduction

1.0 Legislation

The Surveyors Act 1977 as amended provides for:

- the constitution of the Surveyors Board of Queensland.
- the qualifications of persons for registration as surveyors, surveying graduates and surveying associates.
- the constitution of a Surveyors Disciplinary Committee.
- the regulation of the practice of surveying.

2.0 Authority For Directions

2.1 Section 77 (1) (fa) of the Surveyors Act 1977 states that the Governor-in-Council may make regulations not inconsistent with the Act providing, with respect to the powers of the Board relating to securing compliance with the regulations, the issue by the Board of directions to surveyors in relation to the performance of surveys and the achievement of the prescribed standards of accuracy;

2.2 Section 5 of the Surveyors Regulation 1992 provides for the issue of those directions.

“Board’s directions

5.(1) The Board may issue directions to surveyors in relation to the performance of surveys and the achievement of the standards of accuracy specified in this regulation.

(2) Without limiting subsection (1), directions may be given in relation to the storage, transfer and use of electronic survey data.

(3) A surveyor must comply with the directions of the Board”.

3.0 Review

These Directions will be under constant review and the Board would appreciate **constructive comment in writing** to ensure that the purpose of the Directions is at all times legitimate.

The Board will be constantly reviewing all survey legislation to ensure that professional integrity is promoted. The Board is ever conscious of the need to prevent the introduction of restrictive clauses that inhibit professional practice.

4.0 Departure From Directions

A surveyor may use any method and/or equipment in performing a survey where it can be demonstrated that such method and/or equipment is capable of achieving the purpose of the survey.

Where a surveyor uses methods and/or equipment which involve a significant departure from any Direction, the surveyor shall submit with the survey records sufficient information to identify the methods and/or equipment used.

5.0 Definitions

Relevant definitions have been sourced from appropriate legislation. The definitions reproduced below are those which are referred to elsewhere in this Section.

"AMG" means the Australian Map Grid specified in the Australian Geodetic Datum Technical Manual of the Australian Survey and Land Information Group; (*Surveyors Regulation 1992*).

"bed and banks" with reference to a watercourse or lake means land over which the water of that watercourse or lake normally flows or that is normally covered by that water whether permanently or intermittently. The term does not include land abutting or adjacent to the bed or banks that is from time to time covered by flood water. For the purposes of this definition "bed" means the relatively flat and "banks" the relatively steep portions of the first mentioned land; (*Water Resources Act 1989*).

"cadastral survey" means any process of determining, mapping or planning the boundaries of a piece of land or waters required or authorised-

- (a) under any Act dealing with the alienation, leasing, and occupation of Crown lands or with mining, or affecting titles to land; or
- (b) by the proprietor, lessee or mortgagee under any Act affecting titles to land; or
- (c) by the owner, proprietor, lessee, mortgagee or occupier of, or any person holding a registered interest in, any land for the re-establishment of, or identification of, or adjustment of any boundary of such land; or
- (d) under any Act to be made or certified by a licensed surveyor; (*Surveyors Act 1977*).

"encroachment" means encroachment by a building, including encroachment by overhang of any part as well as encroachment by intrusion of any part in or upon the soil; (*Property Law Act 1974*).

"high water mark" means the ordinary high water mark at spring tides (*Land Act 1994*).

“identification survey” means a cadastral survey carried out for the purpose of identification, re-establishment, marking or remarking of existing boundaries of a piece of land or waters (*Surveyors Act 1977*).

“natural feature” means a topographical feature suitable for use as a boundary in a cadastral survey, and includes-

- (a) a mountain range; and
- (b) a cliff; and
- (c) a river; and
- (d) a watercourse; and
- (e) a seashore; (*Surveyors Regulation 1992*).

“occupation” means a permanent improvement situated on or near the boundary of land, and includes-

- (a) a building; and
- (b) a fence; and
- (c) a wall; (*Surveyors Regulation 1992*).

“plan” includes any survey plan, sketch for identification survey, map, aerial photograph or description made or obtained as part of any survey or surveys; (*Surveyors Act 1977*).

“State Control Survey: - A survey of high precision being carried out at the direction of the Surveyor-General for the purpose of establishing permanent marks to enable surveys throughout the State to be co-ordinated. (*Survey Co-ordination Act 1952*).

“supervision”, in relation to a survey, means the immediate personal oversight of the planning and execution of the survey, including:

- (a) the method of measurements; and
- (b) the placement of survey marks; and
- (c) the preparation of the plan of survey; and
- (d) in the case of a cadastral survey, the examination of evidence of ownership relied on when fixing an existing boundary; (*Surveyors Regulation 1992*).

“survey” means the act or process of determining the form, contour, position, area, height, depth or any other similar particulars of the earth's surface, whether on land or water, or of any natural or artificial features on, below or above any part of that surface or planning the position or the length and direction of the bounding lines of any part of that surface, or of any such natural or artificial features thereof and includes the making or obtaining of a plan or plans thereof; (*Surveyors Act 1977*).

“survey mark” means a mark of the prescribed form used for the purposes of a survey. (*Surveyors Act 1977*)

“survey records” means the documents necessary to adequately record every aspect of the survey. (*Surveyors Regulation, 1992*).

Directions

1.0 Survey Plans (Section 30 Surveyors Regulation 1992)

- 1.1 Lodgement of plans shall conform to the requirements of the Registering Authorities.
- 1.2 Sample plans for a variety of land actions are contained in the Survey Plan Guidelines.

2.0 Stakings

2.1 Construction Process

“Staking” or marking the approximate location of the position of the boundary or corner of a parcel of land is not permissible unless it is part of the process in carrying out the subdivision of new parcels of land. If it is to be used, it must be as an integral part of the procedure required during subdivision.

“Staking” to indicate proposed boundaries in a new subdivision prior to final marking is acceptable as a means of identifying construction or other works involved in the new subdivision under the *Land Sales Act*.

A new subdivision process terminates with the registration of the survey plan.

2.2 Definition

“Staking means placement of appropriate marks, other than survey marks, to indicate the location of proposed boundaries and/or corners of allotments in a new subdivision as a preliminary part of, but prior to the completion of, a cadastral survey”.

2.3 Land Sales Act

“Staking” of allotments under the *Land Sales Act*, through the placement of marks, other than survey marks specified in the *Surveyors Regulation 1992*, is allowed as follows:

- The definition of staking set out in 2.2 is to be noted.
- A registered licensed surveyor may place or supervise the placement of temporary marks of an appropriate nature, other than survey marks, which are suitable for the circumstances and which are clear and intelligible both to surveyors and to the public.

- The registered licensed surveyor shall maintain records of the placement of stakes which were placed for the purpose of pre-selling of allotments under the *Land Sales Act*. Such records shall be maintained until the surveyor places survey marks under the provisions of the *Surveyors Regulation 1992*.
- The absolute position of any stake placed for the purpose of pre-selling proposed allotments shall not vary by more than 0.2m, from the final position of each boundary mark such that the final linear dimensions of the boundary conform to the proposed linear dimensions of the allotment in accordance with the provisions of the *Land Sales Act*.
- Should a registered licensed surveyor be required by the vendor or the purchaser to place survey marks to identify the boundaries on corners of an allotment, the requirements of s.30(1) of the *Surveyors Regulation 1992* shall be met.

3.0 Long Line Easements

- 3.1 There has always been a requirement to survey easements in accordance with the Surveyors Act 1977 and Surveyors Regulation 1992 and the guidelines contained in this Manual. The Act and Regulation give Registered Licensed Surveyors the ability to use their professional discretion to provide clients with alternative solutions, provided these are acceptable to the Registering Authority and protect the public interest.
- 3.2 The SOM at Section E3 page 30 item 7.13, details the requirements for long line easements surveys. These requirements were developed for easements in rural lands where individual easement lengths were only several kilometres long. This resulted in boundary lines being intersected, reinstated and marked at relatively close intervals.
- 3.3 In recent years there has been a significant increase in easements for infrastructure corridors (for example, gas, water, and slurry pipelines) in remote/rural areas. These easements range from a few kilometres to many tens of kilometres in length. Many of the road and property boundaries in these remote/rural areas may be unsurveyed. These infrastructure corridors provide an opportunity to integrate the cadastre across large tracts of remote/rural land and assist in developing a homogeneous coordinate system.
- 3.4 Further infrastructure development in remote/rural areas may lead to the need to identify other long term interests in land. The following are *minimum* requirements that should apply to all long line cadastral surveys

3.5 Basic criteria :-

- i) The marking of the survey must be such that the property owner can unambiguously identify the easement.
- ii) All corners must be capable of reinstatement and be appropriately marked.
- iii) The survey must be capable of unambiguous interpretation.
- iv) The existing cadastre must be maintained and enhanced.
- v) The requirements of the Survey Co-ordination Act must be met in relation to the placement of permanent marks.

3.6 Specific guidelines :-

- a) Intersections with the underlying cadastre are to be marked according to the Surveyors Regulation, ie with boundary marks and reference marks. This applies to both existing surveyed and unsurveyed boundaries.
- b) The existing cadastre, where it is reinstated, is to be preserved and additional reference marks placed wherever possible to enhance the cadastre.
- c) Boundary marks and reference marks are to be placed at bend points along the corridor, as well as at appropriate spacings along the corridor. Appropriate spacings for boundary marks and reference marks are at nominal 1 km intervals.
- d) Permanent Marks (for example star pickets with concrete collars, marks in above ground structures, etc.) are to be placed or located at strategic locations along the corridor, such as at boundary intersections, bends points or at nominal 5 km intervals.
- e) The boundary marks would normally include pegs or alternative durable marks. Reference marks are to be placed in accordance with best practice. Consideration should be given to placing a range of sub-surface and visible surface marks (including connections to above ground structures within the infrastructure corridor). This is considered to be particularly applicable on surveys of large extent.

The use of reference trees and blazed trees can assist in the reinstatement of surveys in remote/rural areas. However surveyors should be aware that in some localities the taking of reference trees and the blazing of trees may be prohibited or not prudent for a range of reasons, including landholder, environmental and aboriginal cultural heritage reasons.

- f) Where the project has been coordinated or where GPS is to be used as part of the cadastral survey, AMG coordinates are to be shown for relevant permanent marks, boundary marks and/or reference marks.

Survey records should contain details of the methodology and the origin used.

4.0 Permanent Marks

The basic criteria listed in 4.6 are issued as a Direction effective from 1 July 1998.

- 4.1 There are obligations under the Survey Co-ordination Act 1952 and the Surveyors Act 1977 and their accompanying Regulations for surveyors to place or connect to permanent marks during the carrying out of surveys.

Regulation 29(1) of the Surveyors Regulation 1992 states: "To facilitate reinstatement of a cadastral survey and integration of the survey into the State Control Survey, a licensed surveyor must make connections to permanent marks within the survey unless the surveyor considers that it is not practical."

- 4.2 Section 7 of the Survey Co-ordination Act grants power to the Chief Executive to require connection of proposed surveys to permanent marks. Under Section 12(3) of the Survey Co-ordination Act, surveyors are required to connect to at least two permanent marks in any proclaimed survey area.

- 4.3 In recent years, the Department of Natural Resources has been attempting to place some rigour into the requirement to place or connect permanent marks within cadastral surveys through imposing a mandatory requirement in relation to ten or more lot subdivisions or surveys requiring extensive traversing of boundaries.

- 4.4 Connections to permanent marks are recommended for all surveys including identification surveys.

- 4.5 In the interests of furthering the concepts of survey integration and contribution to a co-ordinated cadastre, the following are **minimum** requirements that should apply to all reconfiguration surveys presented on Survey Plans where field survey is undertaken.

4.6 Basic Criteria:

- i) Examine the density of existing permanent marks in the proximity of the survey to determine whether it is necessary to place additional permanent mark/s.
- ii) Establish the status of existing permanent marks to determine the availability of AMG. Where AMG is available, at least two marks should be connected to and the survey related to the AMG meridian.
- iii) Otherwise, the survey should be connected to at least two existing or new permanent marks. When placing a new mark, its site should be selected to facilitate future co-ordination by GPS.
- iv) For surveys within or adjoining Proclaimed Survey Areas, connection must be made to at least two established permanent marks and the survey placed on AMG meridian.

GUIDELINES FOR PREPARATION OF SURVEY PLANS

PART E2

INTRODUCTION

These Guidelines outline the recommended drafting practices which the Surveyors Board of Queensland believe will satisfy the requirements of the Registering Authorities.

The Guidelines indicate drafting procedures that will ensure:

- plans submitted are suitable for the purpose of the survey
- the property is accurately and unambiguously described so that tenure documents based on the plan will be correct
- the survey data can be incorporated into archives as a resource for future surveys
- survey marks placed by the survey are accurately recorded
- the plans can be reproduced on a reduction scale without loss of clarity and quality.

These procedures support Section 30 of the Surveyors Regulation 1992 and are directed towards achieving consistency in the recording of Surveys and Survey data.

President, Surveyors Board of Queensland.



**Outlining the recommended drafting practices
which the Surveyors Board believe will satisfy
the requirements of the Registering Authorities**



Covers both the

**Department of Natural Resources and
Department of Mines & Energy survey plans**

INDEX

Item	Section
A Abbreviations - Common Trees	1.2
Abbreviations- General.....	1.1
Accuracy.....	1.3
Adjoining Descriptions	1.4
Alignment Offsets	1.5
Alignment Spikes - See Corner References.....	1.21.6
Alterations/ Additions/ Amendments	1.6
AMG Connections.....	1.7
Areas	1.8
About.....	1.8.5
Balance	1.8.3
Calculated.....	1.8.1
B Balance Distances - See Distances	1.28
Bearings.....	1.9
Boundaries - See Linework.....	1.38
Broad Arrow - See Corner Marks & Corner References.....	1.21.3 & 1.21.6
Building Unit Plans - See DNR Requirements.....	E3
Buildings.....	1.10
C Calculated Lines.....	1.11
Cancelled Boundaries	1.12
Centre Lines.....	1.13
Certificates.....	1.14
Channel - See DNR Requirements	Example Plan 4
Cities - See Locality	1.39
Colours - See Ink.....	1.34
Compass Survey	1.15
Compiled Plans	
See DNR Requirements	E3
See DME Requirements	E4
Computer Assisted Drafting	1.16
Connections To Distant Points.....	1.17
Connections Across Roads (subject Lot) - See Dimensions	1.27
- See Linework	1.38
Consolidated Title	1.18
Conversions	1.19
Co-ordinates.....	1.20
Corner Information.....	1.21
See Corner Marks	1.21.3
See Corner References	1.21.6
See General Guidelines	1.21.2
See New Corner Marks	1.21.5
See New Reference Marks & Occupation	1.21.8
See Notations	1.21.9
See Original Corner Marks	1.21.4
See Original Reference Marks & Occupation	1.21.7
See Sample Diagrams A & B after	1.21.9
County Boundary.....	1.22
Creek - See Watercourses.....	1.69
Curved Boundaries.....	1.23

D	Datum.....	1.24
	Departmental Requirements	
	Department of Natural Resources.....	E3
	Department of Mines & Energy.....	E4
	Depth Restrictions - See Surveys In Strata.....	1.64
	Description Of Country.....	1.25
	Diagrams.....	1.26
	Dimensions.....	1.27
	Distances.....	1.28
	Drain - See DNR Requirements.....	Example Plan 4
	Drill Holes - See Corner Marks & Corner References.....	1.21.3 & 1.21.6
E	Easements.....	1.29
	Electric Light Poles - See Corner References.....	1.21.6
	Encroachments - See Buildings.....	1.10
	Esplanades - See Roads.....	1.57
F	Features.....	1.31
	Fence Posts - See Corner Marks & Corner References.....	1.21.6
	Fences.....	1.31
	Field Notes - See Survey Records.....	1.63
	Found - See Corner Information.....	1.21.24
G	Group Title Plan - See DNR Requirements.....	E3
H	High Water Mark.....	1.32
I	Identification Survey.....	1.33
	See Corner Information.....	1.21.4
	See DME Requirements.....	E4
	Improvements - See Buildings.....	1.10
	Ink.....	1.34
	Insets.....	1.35
	Iron Pins - See Corner References.....	1.21.6
K	Kilometre Pegs - See Line Pegs.....	1.37
L	Lapsed Boundaries	
	See DME Requirements.....	E4
	See Linework.....	1.38
	Leases & Lease Plans	
	See DNR Requirements.....	E3
	See DME Requirements.....	E4
	Line Pegs.....	1.37
	Linework.....	1.38
	Locality.....	1.39
	Lots.....	1.40

M	Main Roads Bench Marks - See Corner References.....	1.21.6
	Marks () Etc - See Corner Marks & Corner References.....	1.21.3 & 1.21.6
	Marks Found - See Original Corner Marks.....	1.21.4
	Measurement Only.....	1.41
	Meridian.....	1.42
	Metric Documentation.....	1.43
	Multiple Sheets - See Plan Forms.....	1.49
N	Nails - See Corner Marks & Corner References.....	1.21.3 & 1.21.6
	Natural Features - See Features.....	1.31
	No Mark Placed - See New Corner Marks.....	1.21.5
	No Original Marks - See Original & New Corner Marks.....	1.21.4 & 1.21.5
	North Point & Data Orientation.....	1.44
	Not To Scale.....	1.45
	Notations - See Certificates.....	1.14
	- See Corner Information.....	1.21.9
O	Occupation - See Corner Information.....	1.21
	Offsets.....	1.46
	Original Dimensions.....	1.47
	Original Marks - See Orig. Cor. Marks & Orig. Ref. Marks.....	1.21.4, 1.21.7
	Original Pegs - See Original Corner Marks.....	1.21.4
	Original Portion Boundaries - See Linework.....	1.38
P	Parish Boundary.....	1.48
	Pegs - See Corner Marks.....	1.21.3
	Permanent Marks - See Corner References.....	1.21.6
	Photogrammetric Surveys - See DNR Requirements.....	Example Plan No 23
	Pins - See Corner References.....	1.21.6
	Plan - See Adjoining Description.....	1.4
	- See Plan Forms.....	1.49
	Plan Forms.....	1.49
	Plans In Strata- See Surveys In Strata.....	1.64
	- See DNR Requirements.....	Example Plan Nos 37 & 38
	Plotting.....	1.50
	Pointer Pegs - See Corner References.....	1.21.6
	Poles - See Corner References.....	1.21.6
	Proclaimed Survey Areas.....	1.51
R	Railways - See Adjoining Description.....	1.4
	- See Also Centre Lines.....	1.13
	Ranged Only and Reads Bearings.....	1.52
	Reference Marks - See Corner References.....	1.21.6
	Renewed - See Orig. Cor. Marks & Orig. Ref. Marks.....	1.21.4, 1.21.7
	Reproduction & Reduction - See Scale Of Plans.....	1.58
	Reserved Esplanade.....	1.53
	Reserved Roads.....	1.54
	Reset - See Orig. Cor. Marks & Orig. Ref. Marks.....	1.21.4 & 1.21.7
	Restricted Titles - See DNR Requirements.....	Example Plan Nos 37 & 38
	Resurvey.....	1-55
	Rivers - See Watercourses.....	1.69
	Road Reservation.....	1-56
	Roads.....	1-57

S	Scale Of Plans.....	1.58
	Screws - See Corner Marks & Corner References	1.21.3 & 1.21.6
	Secants.....	1.59
	Sheet Numbers- See Plan Forms	1.49
	Specimen Plans	
	See Department of Natural Resources Requirements	
	See Department Of Mines & Energy Requirements	
	Spikes - See Corner References	1.21.6
	Star Pickets - See Corner References	1.21.6
	State Boundary.....	1.60
	Station Numbers.....	1.61
	Strata Surveys - See Surveys In Strata.....	1.64
	Streets - See Roads	1.57
	- See Styles	1.62
	Styles	1.62
	Survey Records	1.63
	Survey Post - See Corner Marks	1.21.3
	Surveys In Strata.....	1.64
	See DNR Requirements	Example Plan Nos 37 & 38
	Symbols.....	1.65
T	Tabulations	1.66
	Telegraph Poles - See Corner References	1.21.6
	Town - See Locality	1.39
	Traverses	1.67
	Trees - See Abbreviations - Common Trees	1.2
V	Vinculum	1.68
W	Watercourses	1.69
	Watersheds.....	1.70
X		
Y		
Z		

1.1 Abbreviations - General

For the purpose of this Section the following nomenclature has been adopted:-

Dept A shall refer to the Department of Natural Resources

Dept B shall refer to the Department of Mines & Energy

For use where space prevents use of full word.

A limit of three consecutive letters is preferred E.g. Cen. face S.F.P. or C. face S.F.P. (not C.F.S.F.P.)

The full stops denoting an abbreviation may be omitted.

About.....	Abt
Addition.....	Addn
Alignment Spike.....	A.SpK.
Alluvial Mining Claim.....	A.M.C.
Application Post.....	Appln Post
Approximately.....	Approx.
ARCADE.....	ARC.
Australian Geodetic Datum.....	A.G.D.
Australian Height Datum.....	A.H.D.
Australian Map Grid.....	A.M.G.
Avenue.....	Ave.
Balance.....	Bal.
Bank.....	Bk
Bitumen.....	Bit.
Block.....	Blk
BOULEVARD.....	BLVD
BOUNDARY.....	BDY
Brick.....	Br
BROADWAY.....	BDWY
Brook.....	Brook
Building.....	Bldg
Building Unit Plan.....	B.U.P.
Business Area.....	B.A.
Calculated.....	Calc.
Centre.....	Cen. (C)
CHANNEL.....	CHNL
CHASE.....	CH.
CIRCLE.....	CCL.
CIRCUIT.....	CCT.
CLOSE.....	CL.
Coal Mining Lease.....	C.M.L.
Concrete.....	Conc.
Connection.....	Conn
Construction.....	Constn
Continued.....	Contd
Corner.....	Cor.
County.....	Cty
COURT.....	CT
Creek.....	Ck
CRESCENT.....	CRES.
CROWN PLAN.....	C.P.

Datum Post	D Post
Dead	Dd
Deep Driven Mark	D.D.M.
Department of Natural Resources	D.N.R.
Department of Mines & Energy	D.M.E.
D.M.E. Plan	M.P.
Departmental	Deptl
Developmental	Dev.
Diagram	Diag.
Distance	Dist.
Disturbed	Distd
Dog Spike	D. Spk.
Dredging Area	D.A.
Dredging Claim	D.C.
Dredging Lease	D.L.
Drill Hole (& Wing)	D.Hole,D/H. or D/H. & W.
DRIVE	DR.
Easement	Emt
East	E.
Electric Light Pole	E.L.P.
ESPLANADE	ESP.
Exploration Permit	E.P.
Exploration Permit for Coal	E.P.C.
Exploration Permit for Minerals	E.P.M.
Exploration Permit for Petroleum	E.P.P.
EXPRESSWAY	EXPWY
Extended	Extd
Fence Posts:	
Round Fence Post	R.F.P.
Square Fence Post	S.F.P.
Square Concrete Fence Post	Conc.S.F.P.
Round Steel Fence Post)	either
Round Galv.Iron Fence Post)	Steel FP
Steel Fence Post)	or
Tubular Steel Fence Post)	G.I.F.P.
Corner Square Fence Post	Cor S.F.P.
Centre Round Fence Post	Cen R.F.P.
Centre Face Square Fence Post	Cen.Face S.F.P. (C.Face S.F.P.)
Fences: eg. 2 Barbed Wire, 1 Plain Wire	2B.1P
FREEWAY	FWY
Foot	Ft
Found	Fd
Galvanised	Galv.
Galvanised Iron	G.I.
Gold Field Homestead	G.F.H.
Gold Mining Lease	G.M.L.
Ground	Gnd
Group Title Plan	G.T.P.
GROVE	GR
Gully Trap	G/T

Headwall.....	Hdwl
Hectares.....	ha.
HIGHWAY.....	HWY
High Water Mark.....	H.W.M.
Holding.....	Hldg(H.)
Identification.....	Ident
Identification Survey.....	I.S.
Instruction.....	Inst.
Intersection.....	Intsn
Iron Pin.....	I. Pin (I.P. never used)
ISLAND.....	IS.
Kerb.....	Kb
Kilometre (s).....	Km
LANE.....	LA.
Leaning.....	Leang
Left Bank.....	L.Bk
Licensed Gem Claim.....	L.G.C.
Line Peg.....	L.P.
Local Government.....	Local Govt
Low Water Mark.....	L.W.M.
Manhole.....	M/H
Market Garden Area.....	M.G.A.
Mark.....	Mk
Measurement.....	Mmt
Metre (s).....	m.
Mineral Claim.....	M.C.
Mineral Development License.....	M.D.L.
Miners Homestead.....	M.H.
Miners Homestead Lease.....	M.H.L.
Miners Homestead Perpetual Lease.....	M.H.P.L.
Mining Lease.....	M.L.
Mining Title Freehold Lease.....	M.T.F.L.
Mount.....	Mt
Mountain.....	Mtn
Nails:	
Galv. Iron Nail.....	G.I.Nail
Lead Head Nail.....	L.H.Nail
Ramset Nail.....	Ram.Nail
Round Head Nail.....	R.H.Nail
Spring Head Nail.....	S.H.Nail
No Original Mark.....	No O.Mk.
North.....	Nth (N.)
Noted & Checked.....	N & C.
Number.....	No.
Obliterated.....	Obltd
Occupation.....	Occupn
Old.....	Old
Original.....	Orig. (O.)
Original Iron Pin.....	O.I.P.

Original Line Peg	O.L.P.
Original Peg	O.P.
Original Permanent Mark	O.P.M.
Original Pointer Peg	O.Ptr
Original Reference Tree	O.R.T.
Original Survey Post	O.S.P.
Overhead	O/H
PARADE	PAR.
PARKWAY	PKWY
PATHWAY	PTHWY
Peg	Peg(P)
Permanent	Perm.
Permanent Mark	Perm Mk (P.M.)
Petroleum Lease	P.L.
Petroleum Well Location	P.W.L.
Pipeline license	P.Lic.
PLACE	P.L.
Placed	Pld
PLAZA	PLZ.
Plinth	Plth
Pointer	Ptr
Portion	Por.
Power Pole	P.P.
PROMENADE	PROM.
QUAY	QY
RAILWAY	RLY
Ranged	Rgd Only
Reads	Rds
Recreation	Rec.
Redundant Catalogue Plan	R.C.
Registered Plan	R.P.
Reinstated	Reinstd
Remains	Rmns
Remarkd	Remkd
Removed	Remvd
Renewed	Renwd
Reserve	Res.
Reserved	Resd
Residence Area	R.A.
Restricted Mining Claim	R.M.C.
Restricted Mining Purposes Claim	R.M.P.C.
Right Bank	R.Bk
Right of Access	R. of A.
Right of Way	R. of W.
RIVER	RIV.(R)
ROAD	RD
S.M.L.	
Special Perpetual Mining Purposes Lease	S.P.M.P.L.
Spike	Spk.
Standard	Stand
Star Picket	S.Pkt

Station.....	Stn
Straightened.....	Strghd
Strainer.....	Strr
STREET.....	ST
Stump.....	Stp
Suburban.....	Subn
Surface.....	Surf.
Surface Area.....	Surf. Area (S.A.)
Surveyed.....	Survd
Survey Plan.....	SP
Tailings Area.....	T.A.
Telegraph Pole.....	T.P.
TERRACE.....	TER.
Traverse.....	Trav.
Unallocated State Land.....	U.S.L.
Underground.....	U/G
Very Old.....	V.Old
Water Hole.....	W.H.
Water Right.....	W.R.
Watershed.....	W'shed
West.....	W.

If Upper and Lower case is used for a word to be abbreviated, then use Upper and Lower case for abbreviation eg:

RAILWAY - RLY ; Railway Fence - Rly fence;

CHANNEL - CHNL; Kerb and Channel - Kerb & Chnl

1.2 Abbreviations - Common Trees

Bauhinia	Bauh.	Mahogany	Mahog.
Beefwood	Beefwd	Mangrove	Mgrove
Blackbutt	Bkbutt	Messmate	Mmate
Blackwood	Blackwd	Milkwood	Milkwd
Bloodwood	Bldwd	Moreton Bay Ash	M.B. Ash
Bollywood	Bollywd	Nutwood	Nutwd
Bonewood	Bonewd		
Bottle Brush	Bot. Brush	Peppermint	Pmint
Bottle Tree	Bot. Tree	Pepperwood	Pepperwd
Boxwood	Boxwd	Poplar Gum	Pop. Gum
Brigalow	Brig.		
Cabbage Gum	Cab. Gum	Quandong	Qdong
Camphorwood	Camphwd	Rosewood	Rosewd
Candlenut	Candnt		
Cheesewood	Cheesewd	Saffron Heart	Saf. Heart
Coachwood	Coachwd	Sandalbox	Sandbox
Coolibah	Coolbh	Sandalwood	Sandwd
Corkwood	Corkwd	Sassafras	Sasfras
Cottonwood	Cottonwd	Satinwood	Satinwd
Cypress Pine	Cy. Pine	Scrubtree	Scrub
		Scrubwood	Scrub
Dead Finish	Dd Fin.	Silkwood	Silkwd
		Spotted Gum	Sp. Gum
Fibrewood	Fibrewd	Stringybark	Stybk
Gum Topped Box	G.T. Box	Tallowwood	Tallowd
		Tulipwood	Tulipwd
Ironbark	Ironbk	Turpentine	Turp.
Ironwood	Ironwd		
Johnson River Hardwood	J.R. Hardwd	Whitewood	Whitewd
		Yellowjacket	Y Jacket
Kurrajong	Kjong	Yellowwood	Yellowd
Lancewood	Lancewd		

(Other tree names are generally shown in full)

1.3 Accuracy

- 1.3.1 Under the Surveyors Regulation 1992 "the word "accuracy" has the commonly understood meaning - precise, exact, correct in accordance with a standard - and so has a wider meaning than that frequently used by surveyors when referring to accuracy of measurement".

Certification of the words used in Form 13, 17, and 18 of the Surveyors Regulation 1992 (Section 25 and 30) - "that the plan is accurate" implies a declaration that the plan is correct in every detail and is in accordance with the standards of accuracy specified in the Surveyors Regulation 1992 and is suitable for the intended action.

For Section 25 compiled plans, the word "accurate" also applies to the available information from which the plan is compiled, regardless of the surveyed status of that available information. (Section 31 (7) of Surveyors Regulation 1992.)

See also "PLOTTING" 1.50 and "SCALE OF PLANS" 1.58
See also Dept A Example Plans 5 to 8 and Explanatory Notes.

1.4 Adjoining Description

- 1.4.1 All adjoining information will be shown in sloping hairline.

See also "STYLES" 1.62.3

- 1.4.2 For all Registering Authorities the latest adjoining registered descriptions and relevant catalogue numbers are to be shown as follows:

Sample

<i>21</i>	<i>42</i>	<i>ML 4</i>	<i>16</i>
<i>SL10432</i>	<i>CP808793</i>	<i>MP34567</i>	<i>RP123456</i>

NOTE:

- *P12345* is never shown - show *RP123456* regardless of status for plans.
- Country Prefixes, e.g. SL, WD etc, no longer form part of the Catalogue Number for new plans of State Tenure and the Term "Registered Plan" no longer forms part of the plan number for Freehold Tenure. Plan prefixes have been replaced by a generic SP (Survey Plan) which will form part of the Catalogue Number and shall be shown as such for adjoining descriptions. (See above example).

Ongoing surveys involving several plans should show the most recent adjoining descriptions pertinent to that survey (ie. show the new description created on the survey as adjoining information).

See also 'Plan Forms' 1.49

1.4.3 Adjoining Easements

Sample	<i>Emt A</i> SL20657	<i>Emt G</i> RP213175	<i>Emt J</i> CP12345
---------------	-------------------------	--------------------------	-------------------------

- Show existing Easements and Registered Plan numbers that abut the subject boundary.

See also "EXISTING REGISTERED EASEMENTS" 1.29.2

1.4.4 Adjoining Railways

- Show Railway Name in all cases
- For Land held by the Queensland Rail in a Certificate of Title, the full RP. Description **must** also be shown.

See also Dept A requirements E3-10.11 & B2.

1.4.5 Adjoining Building Units Or Group Title Plans

- In addition to adjoining Lot on Plan descriptions the adjoining registered Building Units Plan Number or adjoining registered Group Title Plan Number must also be shown.

Sample	<i>BUP 6418</i> 2 RP264458	<i>GTP 5942</i> 6 RP238671
---------------	---	---

This information is obtainable from the reverse side of the plan form and/or a search of the Dept A Computer Inventory of Survey Plans (CISP) and Dept A Office Working Maps.

1.4.6 Adjoining Dept B Descriptions

- All existing and underlying Tenures are to be shown.
- Provided the Mining Tenure can be described by reference to a "Lot on Plan", then the "Lot on Plan" description only will suffice.

See also "Dept B SPECIMEN PLAN"

1.5 Alignment Offsets

Offset lines should be avoided if possible.

Offset marks should be referenced as a direct connection from corners.

See also "CORNER REFERENCES" 1.21.6

1.6 Amendments/ Additions/Corrections to Plans

1.6.1 For Plans "deposited" in Dept A District Offices or "lodged" in Dept B

- Before a plan is "Endorsed" (Dept A) "Registered" (Dept B) any alterations will be effected by erasure and corrections and additions shown in black. In most cases this will entail the return of the plan to the Surveyor.
- Once the plan is "registered" any alterations or additions will be effected by "crossing out" and amending in red. In these cases the plan will be suitably endorsed with a qualifying statement signed by the designated Officer.

See also Dept A Requirements E3-5.1 Corrections to Plans

See also Dept A Requirements E3-5.8 Patent Error

See also Dept A Requirements E3-5.7 Surveyors Book

1.7 A.M.G. Connections

Whenever any survey has been connected to a co-ordinated point on the Australian Map Grid (AMG), the co-ordinates may be tabulated.

AMG co-ordinates are to be computed in accordance with The Australian Geodetic Datum Technical Manual - Special Publication Number 10.

See also "CO-ORDINATES" 1.20

See also "CORNER INFORMATION DIAGRAMS A & B"

See also "MERIDIAN" 1.42

See also "MERIDIAN" Dept A Requirements E3-11.9

See also "AMG CONNECTIONS" Dept A Requirements E3-11.9.1

1.8 Areas

A calculated area is preferred. In the case of Balance lots, a balance area may be acceptable if that lot does not close within the prescribed limits, or where otherwise appropriate.

Eg. -- A remaining lot bounded by a watercourse which has not been re-traversed during the course of survey.

1.8.1 Calculated

Parcels of land which are to exhibit a calculated area will be deduced by closure and adjustment (preferably Bowditch) and shown -

1.8.1.1 In square metres to the nearest square metre where the parcel is less than one hectare. This includes Access Restriction Strips.

1.8.1.2 In hectares to four significant figures.

- 1.8.1.3** Where land is of very small extent (less than one square metre) and of high value (inner city area), the area may be shown to not more than one decimal point.

See also "METRIC DOCUMENTATION" 1.43

1.8.2 Multiple Line Areas

- 1.8.2.1** It is no longer a requirement to show multiple line areas on new plans. An exception is where the block contains a Reservation in Title in terms of Section 23 of the Land Act.

- 1.8.2.2** When working from an original plan with a multiple line area, deductions for the new plan area are always taken from the existing "Nett" or "Balance" area.

- 1.8.2.3** Only the true Nett area of a Lot is shown regardless of other Lots whether fully surrounded or not, or included Road etc.

1.8.2.4 Example Involving Original Multiple Line Areas:

- 1.8.2.5** By computation and adjustment, information from the computer is:

gross area	184.4746378	ha
and road area	20.5822597	ha
by subtraction the nett area is	163.8923781	ha

Plan presentation will be 163.9 ha

NOTE: The "rounded" nett area is adopted.

- 1.8.2.6** If the road was existing and

-- in imperial units, say 50 ac 3r 17p		
-- calculate gross area as in 1.8.2.5		
-- conversion of imperial road area		
(vide 1.19) gives	20.5808	ha
-- calculation provides a 'nett' area of	163.8938378	ha

Plan presentation will be 163.9 ha

NOTE: The "rounded" nett area is adopted.

1.8.3 Balance

Where a balance area may be adopted, the new nett area is determined by SUBTRACTING the surveyed area (rounded as prescribed) FROM THE EXISTING NETT AREA of the parcel.

NOTE: There is no rounding of this resulting area.

Examples Involving Multiple Line Areas

1.8.3.1	existing plan shows	85.1.17		
		4.3.11	Rd	
		80.2.6		
	by survey lot 4 is created:	4.19	ha	
	convert existing imperial nett area to metric (vide 1.19)	32.5924	ha	
		<u>- 4.19</u>	ha	(New Lot 4)
	by subtraction the new nett deduces	28.4024	ha	
	plan presentation will be	28.4024	ha	Bal

NOTE: The "unrounded" nett area is adopted.

1.8.3.2	existing plan shows	158.534	ha	
		2.134	ha	Rd
		<u>156.4</u>	ha	
	by survey lot 4 is created:	123	m ²	
	by subtraction the new nett deduces	156.276	ha	
		Plan presentation will be	156.276	ha

NOTE: The "unrounded" nett is adopted.

1.8.4 Imperial Exclusions (eg Road Reservation etc Sec 23 of Land Act)

Where the area of original exclusions (Road reservation, Forestry Entitlement Area etc.) are imperial, these are converted to the nearest square metre and a three line area shown on the plan. Eg.

34.5425	ha		
1.9501	ha	Rd	Resn
32.5924	ha	Bal	

See also "RESERVATIONS IN TITLE" Dept A Requirements E3-1.5

See also "CONVERSIONS" 1.19

See also "VINCULUM" 1.68

See also "AREAS" Dept A Requirements E3-11.1

See also "VINCULA" Dept A Requirements E3-11.17

1.8.5 "About" Areas

Show to 3 significant figures

See also "Dept A Example Plan" No. 7 & explanatory notes.

1.9 Bearings

1.9.1 Bearings are shown upright on face of plan, sloping in all tabulations & in a clockwise direction for completed blocks.

1.9.2 Bearings to be shown in degrees, minutes & seconds, rounded off as appropriate & reduced to the meridian of the survey.

1.9.3 It is preferable that the following use of '0' be adopted.

eg. 270°0', 270°03', 270°00'30"

Note that 270°00'00" is to be avoided.

See also "DIMENSIONS" 1.27

See also "RANGED ONLY & READS BEARINGS" 1.52

See also "ORIGINAL DIMENSIONS" 1.47

See also Dept A example plan No 7 & explanatory notes.

1.10 Buildings

Encroachment must be clearly illustrated and may be shown as follows:

Sample

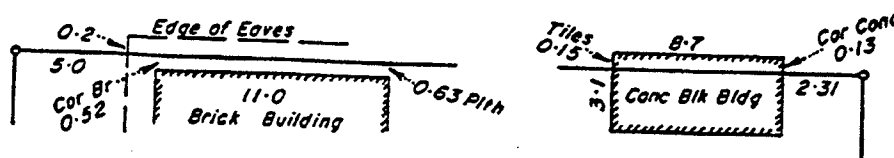

See also Section 26.2 of the Surveyors Regulation 1992.

See also "ENCROACHMENT" Dept A Requirements E3-11.7

See also Recommended Practice 104.0 E1

1.10.2 When classified as a reference mark (immovable object), connections thereto may be shown "on face" or tabulated in required manner.

1.10.3 Other improvements such as bridges, dams, mine shafts, etc., may be shown if connected to in the course of survey.

See also "CORNER REFERENCES" 1.21.6

1.11 Calculated Lines

1.11.1 Calculated lines are those lines derived by computation from survey information.

1.11.2 Show as full lines with computed bearings and distances, and the word "Calc". Show "Calc Orig" on successive plans.

1.11.3 If appropriate to tabulate, show 'Calc' outside column.

See also "EASEMENTS" 1.29

See also "UNSURVEYED AND CALC BNDRIES" Dept A Requirements E3-11.16

1.12 Cancelled Boundaries

1.12.1 These are boundaries rendered redundant by the new survey and are shown by broken lines of about 6mm lengths, where necessary.

1.12.2 Once cancelled they are no longer shown on future plans.

Dept B -- Shown with all dimensions on face or tabulated in "TRAVERSES ETC" column - original indicated.

See also "LAPSED BOUNDARIES" Dept B E4 3.11

See also "LINEWORK" 1.38.8

See also "TRAVERSES" 1.67

1.13 Centre Lines

1.13.1 Road Centre Lines

When shown indicate as follows:

Sample

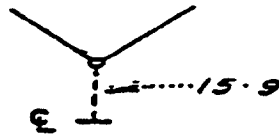

1.13.2 Railway Centre Lines

Connections to "Rly C" are to be shown either on face or by tabulation in the "TRAVERSES ETC" column.

1.14 Certificates

The Surveyor's CERTIFICATE is to be in accordance with Form 13 or Form 18 under either Section 25 or 30 of the Surveyors Regulation 1992 and is valid for twelve months from the date of signature.

If the date of signature lapses, the plan will be re-certified utilising Form 17.

Vide Section 76(a) of the Surveyors Act, 1977.

Sample Certificate -- Licensed Surveyor

[Form 13]

1.14.1 I, John William Brown hereby certify that I have surveyed the land comprised in this plan personally, that the plan is accurate, that the said survey was performed in accordance with the Surveyors Act 1977 and the Surveyors Regulation 1992 and that the said survey was completed on 20/6/92

..... Licensed Surveyor

Date : 30/6/92

**Sample Certificate -- Licensed Surveyor Supervising Licensed Surveyor
[Form 13]**

1.14.2

I, John William Brown hereby certify that I have surveyed the land comprised in this plan by Robert Ellis Junior, Licensed Surveyor for whose work I accept responsibility, that the plan is accurate, that the said survey was performed in accordance with the Surveyors Act 1977 and the Surveyors Regulation 1992 and that the said survey was completed on 20/6/92

..... Licensed Surveyor

Date : 30/6/92

**Sample Certificate -- Licensed Surveyor supervising Registered Person
(Form 13)**

1.14.3

I, John William Brown hereby certify that I have surveyed the land comprised in this plan personally and by Paul Mark Smith, Registered Surveyor * for whose work I accept responsibility, and that the plan is accurate, that the said survey was performed in accordance with the Surveyors Act 1977 and the Surveyors Regulation 1992 and that the said survey was completed on 20/6/92

..... Licensed Surveyor

Date : 30/6/92

(*) Substitute Surveying Graduate or Surveying Associate where applicable.

**Sample Certificate -- Company as Licensed Surveyor supervising Licensed Surveyor
[Form 13]**

1.14.4

J W Brown Surveys Pty Ltd ACN 123456789 hereby certify that the Company has surveyed the land comprised in this plan by Robert Ellis Smith, Licensed Surveyor for whose work the Company accepts responsibility, that the plan is accurate, that the said survey was performed in accordance with the Surveyors Act 1977 and the Surveyors Regulation 1992 and that the said survey was completed on 20/6/92



.....
John William Brown, Director & Licensed Surveyor

.....
Brian Lloyd Gardiner, Director

Date: 30/6/92

Sample Certificate -- Company as Licensed Surveyor delegating supervision to Licensed Surveyor who supervises another Registered Person

[Form 13]

1.14.5

J W Brown Surveys Pty Ltd ACN 123456789 hereby certify that the Company has surveyed the land comprised in this plan by Robert Ellis Smith, Licensed Surveyor and by Paul Mark Smith, Registered Surveyor* for whose work the Company accepts responsibility, that the plan is accurate, that the said survey was performed in accordance with the Surveyors Act 1977 and the Surveyors Regulation 1992 and that the said survey was completed on 20/6/92



.....
John William Brown, Director & Licensed Surveyor

.....
Brian Lloyd Gardiner, Director Date: 30/6/92

(*) Substitute Surveying Graduate or Surveying Associate where applicable.

Sample Certificate -- Licensed Surveyor

[Form 18]

1.14.6

I, John William Brown hereby certify that I have made this plan pursuant to Section 25 of the Surveyors Regulation 1992, and that the plan is accurate and compiled from MP 20261 in the Department of Natural Resources.*

.....
Licensed Surveyor Date: 30/6/92

Sample Certificate -- Company As Licensed Surveyor

[Form 18]

1.14.7

J W Brown Surveys Pty Ltd ACN 123456789 hereby certify that the Company has made this plan pursuant to Section 25 of the Surveyors Regulation 1992, and that the plan is accurate and compiled from CP842126 and RP181275 in the Department of Natural Resources.*



.....
John William Brown, Director & Licensed Surveyor

.....
Brian Lloyd Gardiner, Director Date: 30/6/92

(*) Substitute or add "Department of Mines & Energy, Brisbane" where applicable.

Sample Recertification -- Licensed Surveyor**[Form 17]**

1.14.8 I, John William Brown hereby certify that this plan is accurate at this date of recertification.

.....
John William Brown, Licensed Surveyor Date: 30/6/92

This certificate should be shown on:

- Face of the plan above the Form 13 Certificate; or
- Face of plan; or
- Reverse of plan in area where other certifications are placed.

1.14.9 Surveyors name must be shown in full. The Surveyor should be registered at time of survey and signing of the plan.

1.14.10 If the Surveyor signs his responsibility for another person, the qualifications of that other person must be shown eg. Registered Surveyor, Surveying Graduate or Surveying Associate.

See Section 30 (2) of the Surveyors Regulation 1992.

1.14.11 If responsibility for survey is accepted by a company, the plan must be signed under the Company Seal by two directors, one of whom must be a Licensed Surveyor. The designation of the signatories should be shown.

See Section 14(2)(b) of the Surveyors Regulation 1992.

1.14.12 The date of signature must not precede the survey completion date. The plan must be signed and dated prior to lodgement for sealing with the Local Authority.

1.14.13 All notations including the amendment certificate etc and signatures must be in black ink.

See also "INK" 1.34

See also "Dept B REQUIREMENTS" E4 3.3

1.14.14 Where a plan contains a mixture of survey information and information compiled from other sources, a Form 13 certificate is to be placed on the plan. The Form 13 has relevance to the survey information. A statement indicating the origin of compiled information should be shown on the face of the plan.

1.15 Compass Survey

When parts of the boundary of a block have been previously surveyed by compass, these boundary lines should be noted by the term "COMPASS SURVEY" on face.

Sample

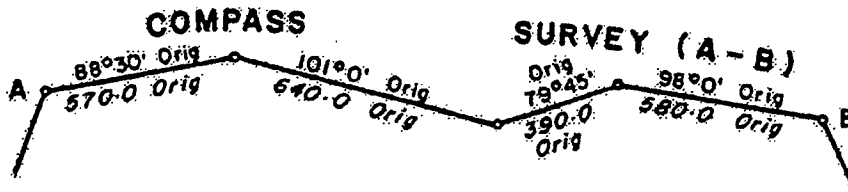

See also "WATERSHEDS" 1.70

1.16 Computer Assisted Drafting

- 1.16.1 This method of plan preparation must follow the same guidelines as set out in this manual.
- 1.16.2 The presentation of lettering styles may vary to those recommended in 1.62 to accommodate the commercial C.A.D. packages available.
- 1.16.3 The size and boldness of the text however must comply with the objective for clarity of information when the plan is reproduced at a reduced scale.

See also "SCALE OF PLANS" 1.58

See also "STYLES" 1.62

1.17 Connections To Distant Points

"Reads" Bearings to Beacons, T.V. Towers etc. can be shown on face or entered in the TRAVERSES ETC." column if the plan is crowded.

See also "RANGED ONLY & READS BEARINGS" 1.52

1.18 Consolidated Title

Definition:

A Consolidated Title contains a number of individual parcels of land for which separate Titles can issue upon request.

See also "CONSOLIDATED TITLES Dept A REQUIREMENTS" E3 2.3.1

See also "Dept A Example Plan No 3"

See also "Dept B REQUIREMENTS" E4 Consolidation

1.19 Conversions

Conversion factors to be adopted are as follows:

Links to Metres :	LKS x 0.201168
Distances to be converted to 3 decimal places	
Perches to Square Metres :	Per. x 25.29285264
Perches to Square Metres :	$M2 = (P \times 625) \times 0.201168^2$
Acres to Hectares :	Acre x 0.40468564
Acres to Hectares :	$H = (A \times 10) \times 0.201168^2$
Acres to be converted to the nearest square metre (40 perches = 1 rood; 4 roods = 1 acre)	

See also "AREAS" 1.8

See also "METRIC DOCUMENTATION" 1.43.7

See also "ORIGINAL DIMENSIONS" 1.47

1.20 Co-ordinates

AMG co-ordinates are to be computed in accordance with The Australian Geodetic Datum Technical Manual - Special Publication Number 10.

1.20.1 Co-ordinated Corners

Go-ordinates for Corners of the subject lot may be shown on a plan provided that the origin of those co-ordinates (ie. Permanent Mark shown on DNR Form 6 or Control Station Summary) together with a connection to that Permanent Mark are shown. Plans showing co-ordinates for lot Corners must provide a statement of terrain heights used to determine the co-ordinates.

1.20.2 Co-ordinates - Permanent Marks

All co-ordinates (except those scaled) shown on the face of Survey Plans must clearly identify the origin station/s.

1.20.2.1 A.M.G. Co-ordinates result from a Geodetic Adjustment of Australia - AGD 84 - PRIMARY.

Supplementary Section from :
Surveying and Land Information Group (eg ZZQLD001)
and Department of Natural Resources (eg BRISCON)

1.20.2.2 Provisional A.M.G. Co-ordinates result from a suitable adjustment technique applied to a local control system, the position and orientation of which has been established by connections to control stations with A.M.G. co-ordinates.

1.20.2.3 Derived A.M.G. Co-ordinates result from simple un-adjusted connections, traverses, radiations etc. from existing control stations with A.M.G. or Provisional A.M.G. co-ordinates.

- 1.20.2.4** **Approximate A.M.G. Co-ordinates** are co-ordinates that have not been obtained by computational methods but by careful scaling from a Published Map, or from a point position determined by satellite observation.

1.20.3 Presentation Of Co-ordinates

Co-ordinates may be presented in a panel on the face of the plan as illustrated hereunder.

The accuracy should be tabulated for AMG co-ordinates shown on the face of plans. This should be shown as Class or Order as defined in the Inter-Government Advisory Committee on Surveying and Mapping Standards and Specifications for Control *Surveys*) July 1990, IGAGSM Publication No. 1.

1.20.3.1 A.M.G. Co-ordinates

Sample:

A.M.G. CO-ORDINATES - AGD-84

<i>STATION</i>	<i>EAST</i>	<i>NORTH</i>	<i>ZONE</i>	<i>ORDER</i>
<i>GRAVATT SM 40337</i>	<i>455 031-799</i>	<i>7 019 023-527</i>	<i>56</i>	<i>1</i>

1.20.3.2 Provisional A.M.G. Co-ordinates

Sample:

*PROVISIONAL A.M.G. CO-ORDINATES - AGD-84
CAIRNS - CORMORANT PASS REEF MAPPING*

<i>STATION</i>	<i>EAST</i>	<i>NORTH</i>	<i>ZONE</i>	<i>ORDER</i>	<i>CLASS</i>
<i>PM 46307</i>	<i>439 572-255</i>	<i>7 256 243-661</i>	<i>56</i>		<i>C</i>

1.20.3.3 Derived A.M.G. Co-ordinates

Sample:

DERIVED A.M.G. CO-ORDINATES AGD-84

<i>STATION</i>	<i>EAST</i>	<i>NORTH</i>	<i>ZONE</i>	<i>CLASS</i>
<i>PM 21899</i>	<i>500 301-361</i>	<i>6 974 239-173</i>	<i>56</i>	<i>D</i>

1.20.3.4 Approximate A.M.G. Co-ordinates

Sample:

APPROXIMATE A.M.G. CO-ORDINATES

<i>STATION</i>	<i>EAST</i>	<i>NORTH</i>	<i>ZONE</i>
<i>PM 20657</i>	<i>457 200</i>	<i>7 624 520</i>	<i>56</i>

- 1.20.4** For provisional and derived A.M.G. co-ordinates the descriptions and values of the points from which these co-ordinates were generated, together with the associated computations (including height determinations) should form part of the survey record.

See also - "A.M.G. CONNECTIONS" 1.7

See also - "CORNER INFORMATION" 1.21 - DIAGRAMS A & B

See also - "MERIDIAN" Dept A Requirements E3 11.9

See also - "PERM SURVEY MARKS" Dept A Requirements E3 11.1

See also - "PROCLAIMED SURVEY AREAS" Dept A Requirements E3 11.12

See also "AMG CONNECTIONS" Dept A Requirements E3-11.9.1

1.21 Corner Information

- 1.211** Corner information deals with the method of presentation on the face of the plans for:

➤ **Corner Marks**

i.e. ORIGINAL Corner Marks and NEW Corner Marks

➤ **Corner References**

i.e. ORIGINAL Reference Marks (& Occupation) and NEW Reference Marks (& Occupation)

➤ **Notations**

1.21.2 General Guidelines

- 1.21.2.1** Information marking the corner (ie Monument at the corner) should be written first, and information referring to Reference Marks and/or Occupation should be written in order of proximity after the corner mark.

See Diagrams "A" and "B" on following pages .

- 1.21.2.2** It is preferred that Occupation references are determined "square" from the principal lines run (eg. Stn 3 - Diagrams "A" & "B"); except where a bearing and distance is required to avoid ambiguity. (eg. Stn 23 - Diags. "A" & "B")

- 1.21.2.3** Corner information should generally be shown as in Diagram "A" (ie on face") provided the plan can be reproduced at a reduced scale **without loss of clarity**, otherwise the Tabulated method as in Diagram "B" should be used. A mixture of "on face" and Tabulated presentation is to be **AVOIDED**.

Item 1.21.4 continues after Diagrams "A" & "B".

Diagram A (On face presentation)

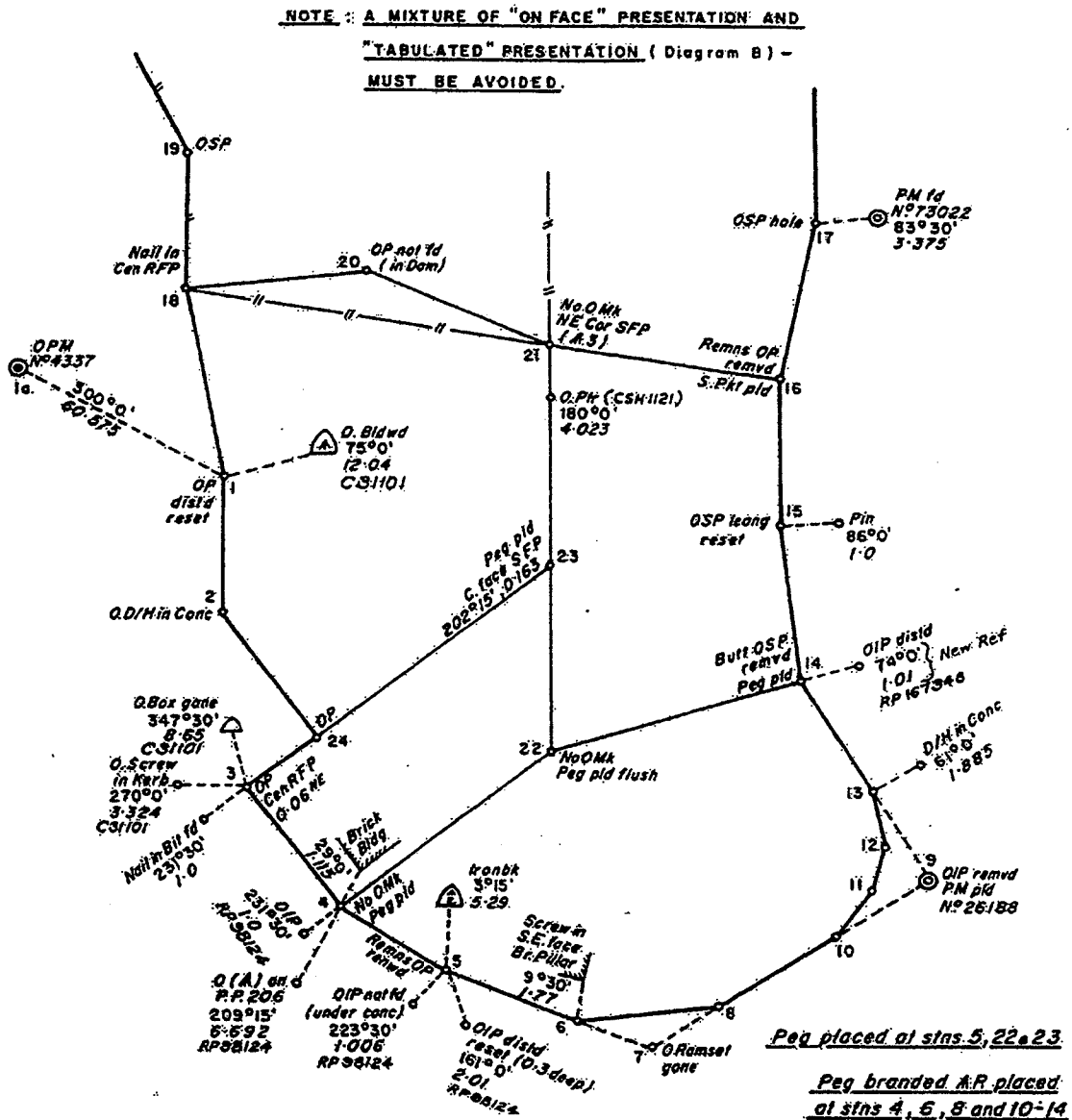

PERMANENT MARKS: When co-ordinates have been established, these may be treated as follows for 'On face' presentation:

Example ...

A.M.G CO-ORDINATES (A.G.D. 84)

STN	EAST	NORTH	ZONE	ORDER
OPM4337	723 569.96	7 657 837.81	57	2

(Enter in 'A.M.G. CONNECTIONS' tabulation)

Diagram B (Tabulated presentation)

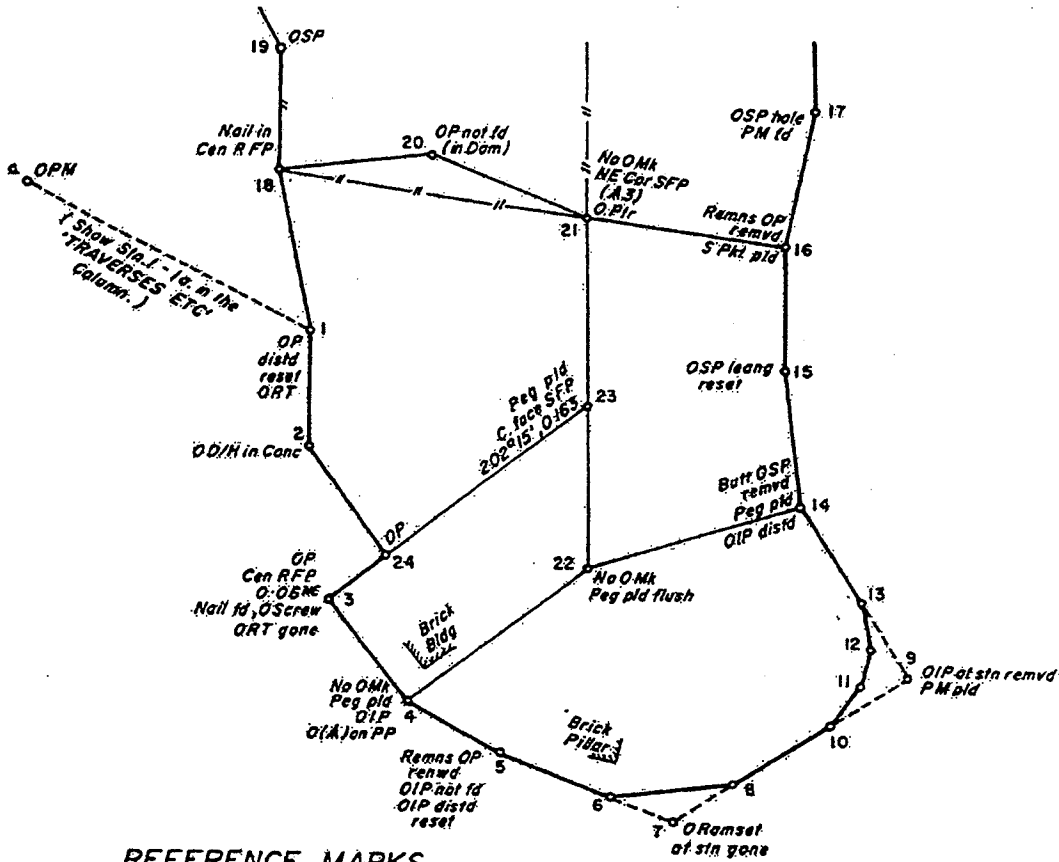

REFERENCE MARKS

STN.	TO	OPEN	BEARING	DIST
1	O Blawa Mk	C3101	75° 0'	12.04
3	Nail Id in Bit	C31101	23° 30'	1.0
	O Screw in Kerb	C31101	270° 0'	3.324
	O Box Gate	C31101	347° 30'	8.65
4	OIP	RP98124	23° 30'	1.0
	Cor Br Blag		29° 0'	1.15
	O A. on RP206	RP98124	209° 15'	6.692
5	OIP not Id. under conc	RP98124	223° 30'	1.006
	OIP reset 0.3 deep	RP98124	161° 0'	2.01
	Ironbk A2		3° 15'	5.29
6	Screw in SE face BR Pillar		9° 30'	1.77
13	D/H in Conc		6° 0'	1.865
14	OIP distd (New Ref)	RP167348	74° 0'	1.01
15	Pin		66° 0'	1.0
21	O Pir	GS1121	180° 0'	4.023

Peg branded AR placed at stns 4, 6, 8 and 10-14

Peg placed at stns 5, 22 & 23.

PERMANENT MARKS

PM	BEARING	DIST	N ^o
1a - OPM	at station		4337
9 - PM	at station		26188
17 - PM	83° 30'	3.375	73022

(NOTE: For Tabulations - listings are consecutive, showing all marks referenced from the station. All reference marks for a station MUST BE KEPT TOGETHER and shown listed at their progressive distances from the station.)

PERMANENT MARKS:

When co-ordinates have been established, these may be treated as follows for 'Tabulated' presentation:

PERMANENT MARKS

AM.G. CO-ORDINATES (A.G.D. 84)

PM	BEARING	DIST	STN	EAST	NORTH	ZONE	ORDER
1a - OPM	at station		OPM4337	723 659.96	7 657 837.81	57	2

(Add to existing 'PERM MARK' tabulation in a suitable format.)

1.21.2.4 The word "found" (fd) written after a mark eg. *Peg fd, Pin fd* etc. denotes a mark at a surveyed position with no origin or cadastral connection shown on a Registered Plan, Identification Survey, Redundant Catalogue Plan, sketch in a Registered Document, or Alignment Marking Files lodged in a Registering Authority.

1.21.2.5 The methods of presentation are influenced by the priority to ensure clarity of information is maintained upon reduction and reproduction of the plan.

1.21.3 Corner Marks

Refers to Survey marks and/or Branded Occupation recovered, placed or adopted at the corner eg. Pegs, Pins, Survey Posts, Star Pickets or Survey Marks recovered or placed in occupation at the corner to represent the corner.

Sample *Nail in Cen RFP ; Ramset in Br Wall ; Screw in Conc.*

(The type of nail can be shown if indicated in the survey records eg. Clout, Ramset, Spring Head etc).

1.21.4 Original Corner Marks

1.21.4.1 When the origin of the mark recovered at the corner is known (ie recorded on a previously registered survey or a lodged Identification Survey or lodged Redundant Catalogue Plan), the mark is classified as "original" and shown by the abbreviation "O".

Sample *OP ; OSP ; O Nail in Cen RFP ; OP (I. S. 2345)*
O Ramset In Br Wall ; O Screw in Conc ;
O Nail in Conc (R.C. 800361); etc.

NOTE: The decision to utilise corner marks shown on Identification Survey and Redundant Catalogue plans for reinstatement purposes rests with the Surveyor.

1.21.4.2 When the origin of the mark recovered at the corner is known, the mark may be identified by the addition of the catalogue number of the plan of origin.

See also - Diagrams "A" and "B".

1.21.4.3 When the **origin** of the mark recovered at the corner is **unknown** (ie no previous cadastral connection on a registered plan, Identification Survey or Redundant Catalogue Plan) the mark should be classified as being "found".

Sample *Peg fd ; Screw in Conc fd; etc.*

- 1.21.4.4** When there is no original survey mark or evidence of any type remaining at the position of the previously surveyed corner, the term "No O Mk" is used.

See also - "NEW CORNER MARKS" 1.21.5

The term "No Mk" is **never** shown on a plan.

- 1.21.4.5** When the original corner mark has become inaccessible since the original survey and hence is not able to be connected to, then the term "not fd", suitably qualified is used.

Sample *OP not fd ; O D/H not fd ; etc*
(in deep fill) (under conc)

- 1.21.4.6** When **remains** of a survey mark or evidence of a survey mark position is found at the corner, the following terms may be used where applicable.

Sample *Rmns OP ; OP hole ; Rmns OSP ; OSP hole ; etc.*

See also - "NEW CORNER MARKS" 1.21.5

- 1.21.4.7** When an existing survey mark is found disturbed and that same mark is **reset** in the original corner position, the following terms may be used where applicable.

Sample *OP distd Reset ; OSP lying out Reset ; etc.*

The term "replaced" should NOT be used.

- 1.21.4.8** When an existing survey mark or remains thereof is removed at time of survey, and is replaced by a new mark of the same type, the Term "renewed" is used.

Sample *Rmns OP ; OP burnt ; Butt OSP ; Peg pld ; etc.*
renwd renwd renwd OP 0.14S; 0.05 W
remvd

The term "replaced" should NOT be used.

- 1.21.4.9** When an existing survey mark or remains thereof is removed at time of survey, and is replaced by a new mark of a **different** type, the term "removed" is used and the new mark quoted.

Sample *OP remvd ; Butt OSP remvd ; etc.*
Post pld Peg pld

- 1.21.4.10** When an existing survey mark or remains thereof has been disturbed at the time of construction works (fencing, retaining wall) and the occupation is adopted at the corner, indicate as follows:

1.21.5.3 Variations such as "*Peg pld in cairn of stones, Peg driven flush, Plastic or Concrete Peg placed, Star Picket pld*" etc must be indicated either "on face" or by statement.

The term "*No Mark pld*" suitably qualified may be used if appropriate.

Sample *No mk pld* ; *No mk pld* ; etc.
(*in swamp*) (*inaccessible*)

1.21.5.4 Occupation adopted as new corner.
(When impracticable to place a Peg or Post)

If a new corner is established at which occupation exists, eg. Fence Post, Walls, Buildings, Poles, Man Holes or any such immovable object, the position of the occupation is referenced from the corner.

Sample *Cen RFP* ; *Cor Br Bldg* ; *C face SFP* ; etc.
0.3s 0.06w *0.02N 0.05E* *220°15', 2.657*

1.21.5.5 When Nails, Screws etc are placed as a new survey mark in occupation to establish the corner, the occupation is referenced.

Sample *Nail in RFP* | *Ramset in Cor Br* | *Nail in Cen RFP at* ; etc.
Cen 0.015s ; *Cor Br 0.12w* | *Stns 1, 4, 6 - 9*
(shown at corner on face) (statement on face)

1.21.5.6 If occupation is adopted as the new corner and is branded, this must also be quoted.

Sample *N.E. Cor SFP (A R)* | *Cen RFP (A 2) at*
Stns 2, 3, 5 - 8
(shown at corner on face) (statement on face)

1.21.6 Corner References (Reference Marks)

1.21.6.1 Refers to **Reference Marks** (eg. Iron Pins, Permanent Survey Marks, Spikes, Nails, Screws, Star Pickets, Broad Arrows, Drill Holes, Pointer Pegs, Marks on Poles, Branded Trees, Bench Marks etc) or **Occupation** (eg. Fence Posts, Walls, Buildings, Poles, Man Holes, Gully Traps or any such immovable objects) which are placed or connected to in the course of the survey.

1.21.6.2 **These marks are in addition to the monument denoting the corner. All connections will be from the corner to the reference mark or occupation.**

- 1.21.6.3** Reference Marks may be shown on the face of the plan. Where space does not permit, references may be shown by diagram or in the "REFERENCE MARKS" Column.

Exception:

Permanent Marks: Show in separate column headed "PERMANENT MARKS"

See also - Diagrams "A" & "B".

1.21.7 Original Reference Marks & Occupation

When the origin of the Reference Marks recovered at the corner is known (ie recorded on a previously registered survey or a lodged Identification Survey or lodged Redundant Catalogue Plan, enabling the true position of the existing corner to be re-established) the mark is classified as "Original" and shown as such by the abbreviation "O". Occupation as evidence of ownership should be recorded.

See Section 26(1)(a) and 26(1)(f) of Surveyors Regulation 1992.

Sample *OIP ; ORT ; O nail in Cen RFP ; O Screw in Conc ; OIP(I.S. 1568) ; etc.*

NOTE: The decision to utilise Reference Marks shown on Identification Surveys and Redundant Catalogue Plans for reinstatement purposes rests with the surveyor.

- 1.21.7.2** When the **origin** of the mark recovered away from the corner is **unknown**, the mark should be described by "found".

Sample *Pin fd ; Nail in Bit fd ; etc.*

- 1.21.7.3** When it is evident the original reference mark is missing or destroyed, the following terms are used.

Sample *OIP gone ; ORT gone ; etc.
(burnt out)*

Connections are shown on the plan if recorded in the field records.

- 1.21.7.4** When the original reference mark has become inaccessible since the original survey, and hence is not able to be found, the term "not fd" suitably qualified is used.

Sample *OIP not fd ; O Nail in Cen RFP not fd ; etc.
(under conc) (in Dam)*

1.21.7.5 When the **remains** of an original reference mark or evidence thereof is found, the following terms are used.

Sample *ORT hole* ; *Rmns OIP* ; etc.
 (burnt out) *(rusted out)*

1.21.7.6 When the existing reference mark is found disturbed or out of position, and that **same** mark is **reset** in the original position, the following terms are used.

Sample *OIP distd* ; *Old S Pkt lying out* ; etc.
 reset *reset*

1.21.7.7 When an original reference mark is removed at the time of survey, and is replaced by a new mark of the **same** type, the term "renewed" is used.

Sample *OIP distd* ; *OPM damaged* ; etc.
 renwd *renwd*

The term "replaced" should NOT be used.

1.21.7.8 When an existing reference mark is found disturbed or out of position and the same mark is **re-referenced**, the following terms are used.

Sample *OIP distd* ; *OIP distd* ; etc.
 (New Ref) *180°0' 1.008 (New Ref)*

1.21.7.9 When the origin of a Reference Mark is known, the mark may be identified by the addition of the catalogue number of the plan of origin - either on the face of the plan or in the Reference Marks column.

1.21.7.10 When an original reference mark is removed at the time of survey and replaced by a new mark of a **different** type, the term "removed" is used and the new mark quoted.

Sample *OIP remvd* ; *O Ptr remvd* ; etc.
 PM pld *Pin pld*

1.21.7.11 When an existing reference mark is found and connected to a new corner of the survey, show as a new connection.

Sample *OIP* ; *ORT Stp*
 New Conn *New Conn*

NOTE: In addition to the connection to the new corner, a connection to the original corner should also be shown in the usual manner.

See also, Diagrams "A" and "B".

Sample

4

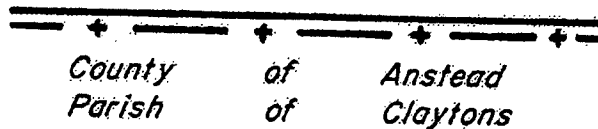

- 1.22.2 County boundaries are not to be shown in the middle of the roadway if both sides of the road are shown.
- 1.22.3 If the opposite side of the road is not shown, the County boundary may be shown in the road, as close as possible to the subject block, but not within the subject block.
- 1.22.4 Show County boundary in middle of Creek or River if space permits. Show County boundary on opposite side of Creek or River to the subject block if space is limited.

See also - "COUNTRY BOUNDARY" 1.38.11
 See also - "STYLES" 1.62 & EXAMPLE PLANS
 See also - "ADMINISTRATIVE BOUNDARIES" Dept A Requirements E3-2.1

1.23 Curved Boundaries

Curved Boundaries are not normally accepted by Dept A for new Cadastral boundaries as the boundary is not readily and unambiguously discernible on the ground at the completion of a cadastral survey (Section 27(a) Surveyors Regulation 1992).

In exceptional circumstances where a curved feature defines the boundary to be adopted, with prior approval of the Dept A, a curved boundary may be utilised.

See also - "CURVED BOUNDARIES" Dept A Requirements E3-11.5

1.24 Datum

Show thus

Sample

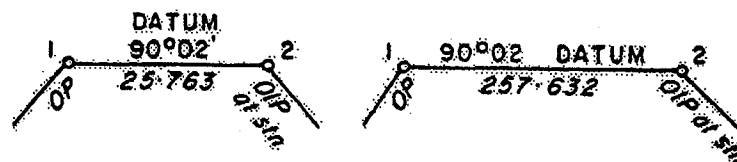

- 1.24.1 For cancelled boundary or traverse.

Sample

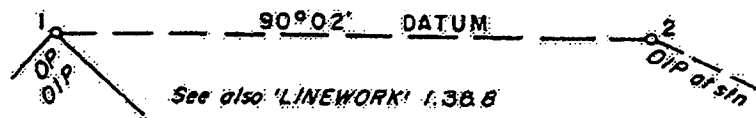

- 1.24.2 Where there are insufficient marks for a datum on one line, the following may be adopted.

Sample

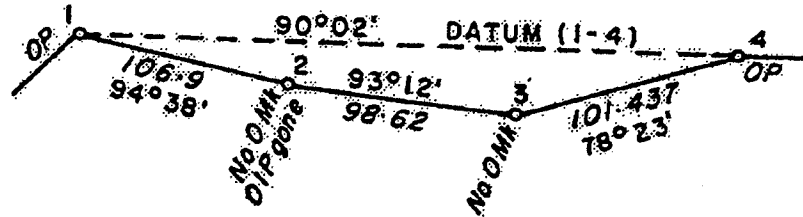

- 1.24.3 When datum is obtained by observation for meridian, show "DATUM BY OBS" on appropriate line.

- 1.24.4 When more than one plan is drafted from the one set of survey records (eg new estates) and the DATUM line is located on one plan only, the following note should be shown on all plans.

Sample *This is one of plans (.... Catalogue N's.....) from the one survey. For DATUM see plan*

See also - "PLAN FORMS" 1.49

See also - "MERIDAN" Dept A Requirements E3-11.9

1.25 Description Of Country

For Dept A:

Description of country may be shown for surveys in rural areas.

For Dept B :

Not required except for natural features.

See also - "FEATURES" 1.30

See also - "SPECIMEN PLAN" - Dept B

See also - "SYMBOLS" 1.65

1.26 Diagrams

- On face of plan show eg. SEE DIAGRAM A
- Lot number - repeat on diagram.
- Roads and Streets, if subject on plan, are shown hairline on diagram.

1.28 Distances

Distances are shown as per survey records.

- 1.28.1** Distances are shown sloping on face of plan and in all tabulations.
- 1.28.2** Always shown inside block.
- 1.28.3** The balance distance shall be deduced from the plan from which the title or deed was issued.

Where the dimensions of the balance are found to be imperfect, or a calculated area is to be adopted, the Licensed Surveyor can then derive data from any registered survey in order to determine the boundaries of the block.

- 1.28.4** Each severance within the subject land should be fully dimensioned if surveyed.

See - also "ROADS" 1.57

1.28.5 Brackets

When intermediate distances are shown, the "through" distance is to be shown with brackets.

Station numbers should be used for clarity.

See also - "ABOUT DISTANCES" & Notes with Dept A Example Plan 7

See also - "DIMENSIONS" 1.27

See also - "METRIC DOCUMENTATION" 1.43

See also - "ORIGINAL DIMENSIONS" 1.47

1.29 Easements

1.29.1 Plan Of Easement Only

Boundaries are broken.

Sample See 1.38.6 Linework -----

- 1.29.11.** Dimensions of the complete surround of an Easement are required in a clockwise direction.

The dimensions of the block of which the subject Easement is within, need not be completed. However a bearing and distance to at least one corner of the subject block **must** be shown.

- 1.29.1.2** The Easement must be shown to scale on the plan form. In addition, a diagram being not to scale may be utilised if required.

- 1.29.1.3 Where Easement boundaries are Calculated, they must be shown as "Calc" on plan.

See also - "CALCULATED LINES" 1.11.3

- 1.29.1.4 Where more than one Easement or Proposed Easement is surveyed in the one tenure, each shall be named with a different letter.

- 1.29.1.5 Where more than one Easement is created on the one plan, they should be named consecutively ie. "C", "D", "E" etc.

See also "DNR REQUIREMENTS" E3-7.7

See also - DNR EXAMPLE PLAN No 11

1.29.2 Existing Registered Easements

- 1.29.2.1 Existing Easements, together with their descriptions and plan number (or dealing number with easements shown on sketch only), shall be accurately plotted on the Subject Lot.

Exception:

- 1.29.2.2 Easements within parcel being resumed by the State. (Existing Easements or part thereof are automatically extinguished in the State Resumption Process).

- 1.29.2.3 For Dept B.

No provision exists to register an Easement over a Mining Lease under the Mineral Resources Act.

See also - "ADJOINING EASEMENTS" 1.4.3

See also - "DEPT A. REQUIREMENTS" E3-7.1 Easements

See also - DEPT A. EXAMPLE PLANS 11, 12 & 13.

See also - "CREATION OF NEW EASEMENTS ON LAND BEING TRANSFERRED TO THE STATE" Dept A. Requirements E3-7.18

See also - "EXISTING EASEMENT ALLOCATIONS" Dept A Requirements E3 4.4

1.30 Features

Both Dept A. and Dept B. plans require natural features such as gullies, mountain ranges, etc. to be shown if located in the course of survey.

See also - "DESCRIPTION OF COUNTRY" 1.25

See also - "SYMBOLS" 1.65

1.31 Fences

- 1.31.1 Type of fence to be shown if possible eg. 2PIB, Netting etc

- 1.31.2** "Read" bearings may be shown on fences that are existing on previous boundary lines.

If useful, "Read" bearings may be shown on internal fences.

- 1.31.3** Connections across roads to fence lines to be treated as follows.

Sample

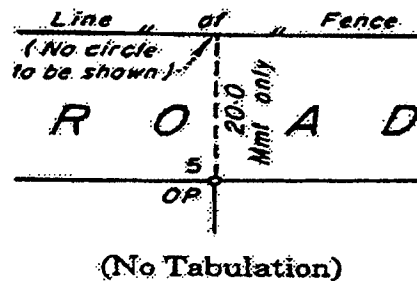

TRAVERSES ETC		
LINE	BEARIN	DIST
	G	
5- Fence	Mmt only	20.0

(With Tabulation)

See also - "RANGED ONLY AND READS BEARINGS" 1.52

1.32 High Water Mark

Boundary dimensions to be shown to HWM where applicable.

See also - "HWM" DEPT A. REQUIREMENTS E3-6.3

1.33 Identification Surveys

For Dept B. Requirements see E2 3.10.

See also - "DEPT A. REQUIREMENTS" E3-11.8

See also - "EXAMPLE PLANS" Nos 16, 17

See also - "ORIGINAL CORNER MARK" 1.21.4.1

See also - "ORIGINAL REFERENCE MARK" 1.21.7.1

See also MEMORANDUM No 8/93, B1.

1.34 Ink

All plans within the definition of the Surveyors Act 1977, lodged or deposited with a Registering Authority for registration, shall be drawn in BLACK INK.

The ink used for drafting, signing (black ink only), amending and noting plans shall be of a permanent and water-proof variety.

Biros and felt pens etc. will not be considered acceptable.

1.35 Insets

This method of plan presentation is to be avoided.

See also - "NOT TO SCALE" 1.45

See also - "SCALE OF PLANS" 1.58

1.36 Lease Plans

See - "DEPT B. REQUIREMENTS" E2-3.12

See - "DEPT A. REQUIREMENTS" E3-8. Leases & E3-20 Sketch Plans

See - DEPT A. EXAMPLE PLANS 20 - 22, 34 & 35

1.37 Line Pegs

When survey records not lodged, new Line Pegs shall be shown on the plan.

Placement of line pegs will be indicated by one of the following methods.

1.37.1 Statement eg Line Peg placed of intervals of 200.0 from Stns 1, 3, 6, 12 & 15

1.37.2 Tabulation eg LINE PEGS

STN	BEARING	DIST.
2	180° 42'	203.53
	180° 42'	406.22
	180° 42'	600.3
5	272° 33'	201.42
	272° 33'	400.63

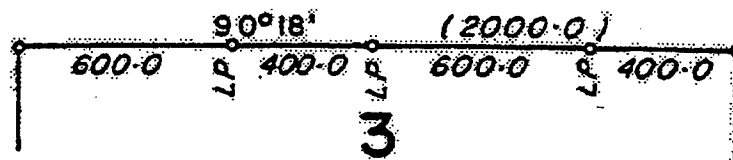

1.37.3 On face of plan eg.

1.37.4 Original Line Pegs

Show "OLP" on face

Measured distances shown in survey records which serve to fix position of OLP, are to be shown on face of plan.

Approximate distances are not shown.

Note: If intermediate pegs are not shown on the plan, survey records showing the position of these pegs **must be lodged**.

Kilometre Pegs are treated in the same manner as Line Pegs. If branded, indicate "on face" or tabulate.

1.38	Linework	
1.38.1	Boundaries of Subject Land	_____
1.38.2	Boundaries of Subject Land across roads (these to be direct connections)	- - - - -
	See also - "DIMENSIONS" 1.27.3	
1.38.3	Dept B. Surface Areas, Right of Access or Right of Way	_____
1.38.4	Adjoining Background Tenures (Dept B.)	_____
1.38.5	Lapsed Boundaries (Dept B.) Original Portion Boundaries (Dept A.)
1.38.6	Easements and Leases:	
	Subject	_____ 12 mm _____
	Adjoining
1.38.7	Traverse, Secants etc .	- - - - - 3 mm - - - - -
1.38.8	Cancelled Boundaries	_____ 6 mm _____
1.38.9	Unsurveyed Line	_____ 12 mm _____
1.38.10	Parish Boundary	_____ . _____ . _____ . _____
1.38.11	County Boundary	_____ + _____ + _____ + _____
1.38.12	State Boundary	_____ x _____ x _____ x _____

The above is a recommended format for line thickness.

Line length and thickness may be varied if clarity of plan will benefit.

1.39 Locality

For Dept A. plan forms, the "TOWN/LOCALITY" segment in the Title Block should state the name of the City, Town, Suburb or District or describe the location of the survey in relation to a permanent feature on a published map. However, if where the original description referred to a gazetted city/town, then that city/town SHOULD be shown.

Local/District names shown in the Title Block should be in accordance with the Gazetteer of Place Names which can be accessed at Dept A. District Offices.

Usage of new Local/District names eg New Estate Developments, should first be referred to Dept A. for consideration under Place Names.

For Dept B. provision exists for the office insertion of the latitude and longitude of the centre of the plan form by scaling if necessary when more accurate information is not available. The stated co-ordinates are strictly for location purposes.

1.40 Lots

1.40.1 Lot numbers are generally shown on Street frontages for urban lands and approximately 1/3 from the top boundary of the Lot for rural lands.

1.40.2 The lot number for the Balance of a block or for an amended block should retain the original numerical identifier.

1.40.3 The numbering of newly created lots can be at the discretion of the Licensed Surveyor provided the numbering is :

- Unique on a plan
- Avoids repetitive use of numbers 1 and 2
- Not similar to numbers of adjoining lots
- Limited to a number of three digits

See also - "LOT ALLOCATIONS" Dept A Reqmts E3-4.1

See also - "PORTION ALLOCATIONS" Dept A Reqmts E3-4.2

See also - "ORIG PORTIONS" Dept A Reqmts E3-9.5

See also - "TRANSFERS TO THE STATE" Dept A Reqmts E3-2.6.

1.41 Measurement Only

Show as required on face of plan or tabulated in the "TRAVERSESES ETC" column.

1.42 Meridian

It is preferable that all surveys be related to AMG.

Vide Section 105.0 Meridian Determination, Part E1.

1.42.1 The meridian of every survey should be indicated as follows.

Sample	<i>AMG Vide Plan WD4829</i>	<i>Add 5° 48' for AMG Vide Plan RP801576 Zone 55</i>	<i>CAM Vide SL1234</i>
--------	-----------------------------	--	----------------------------

Detail is generally shown in the Meridian Box however where space is limited the Meridian information should be shown directly above the Title Block.

Sample *MERIDIAN: Add 6°11' for AMG Vide Plan W31639, Zone 56.*

1.42.2 If observations are taken, details should be tabulated on face of plan.

Sample

MERIDIAN

LINE	PLAN BEARING	A.M.G. BEARING
4-3	15°38'50"	21°26'50"
	<i>ADD 5°48' for A.M.G. - ZONE 55</i>	
	15°38'50"	C.A.M. BEARING
	<i>ADD 0°57' for CAM</i>	16°35'50"

1.42.3 It would be advantageous for continuous surveys to be on the one meridian.

See also - "MERIDIAN" E3-11.9

1.43 Metric Documentation

1.43.1 The symbol "m" will NOT be shown following a length

Eg. 20·115 not 20·115 m

1.43.2 The decimal point is to be **prominently** shown at the mid height of the figures where possible.

1.43.3 Numbers should be grouped in threes right or left from the decimal point, and a space should be used instead of a comma.

Eg. 65 093·762 13 not 65,093.76213

However, except in tabular work (eg. co-ordinates), the space may be omitted in groups of only four figures.

Eg. 4076·3012

1.43.4 A space should be left between the numeral and the unit or unit symbol.

Eg. 5·273 ha not 5·273ha

1.43.5 No full stops will follow symbols.

1.43.6 Use of "zeros."

1.43.6.1 Where the figure is less than one, use a zero before the decimal point.

Eg. 0.745 not ·745

1.43.6.2 For whole numbers, a zero will be shown as the last character of length to the right of the decimal point.

Eg. 4·0, 51·0, 200·0 not 4·00 or 501·20 or 67·530

However, when showing (1) Road widths or (2) Areas, the above procedure is **NOT** to be adopted

Eg. ROAD 60 WIDE not ROAD 60·0 WIDE

Eg. 12 ha not 12·0 ha

1.43.7 Rounding

When rounding to fewer digits than the total number available, the following procedure is adopted.

1.43.7.1 Where the digit immediately following the last digit to be retained is less than 5, that digit should be left as is.

Eg. 7·624 25 to four digits = 7·624

1.43.7.2 When the digit immediately following the last digit to be retained is 5 or greater, that digit should be increased by one.

Eg. 4·624 51 to four digits = 4·625

1.43.7.3 If the digit to be discarded is exactly 5 and there is no indication of what the following digits might be, the last digit retained should be rounded to the nearest even digit.

Eg. 5·4665 rounded to 3 decimals becomes 5·466

5·4655 rounded to 3 decimals becomes 5·466

NOTE:

It is essential that the decimal point be shown as clearly and prominently as possible.

See also "AREAS" 1.8

See also "DIMENSIONS" 1.27

See also "DISTANCES" 1.28

See also "ORIGINAL DIMENSIONS" 1.47

1.44 North Point And Data Orientation

North Point is not shown unless a plan is turned. When it is necessary that a plan be rotated through 90°0' then 270°0' becomes 0°0'.

When a plan is turned, all information is shown orientated accordingly ie. to the North Point, (this includes tabulations and statements). There should be no circumstances where a plan needs to be turned upside down to read any data.

1.45 Not To Scale

Use with discretion. Break line for each block affected. Advantageous to plot this work to 'some scale' for sake of proportional representation. The wording "*Not to Scale*" is to be shown on appropriate line or lines.

See also "INSETS" 1.35

See also "SCALE OF PLANS" 1.58

NOTE:

New surveyed lines of subject blocks are drawn in an uninterrupted manner to the scale as shown in the title.

1.46 Offsets

Not shown on plan in normal circumstances.

If sufficient connections to the boundary line have been made, all information is to be related to the boundary line.

If there are insufficient connections, offset will be shown.

1.47 Original Dimensions

1.47.1 Shown with "Orig" written in conjunction with each bearing and distance. "Bal" to be used for subtraction. "By Addn" can be used for additions.

Sample

$\frac{270^{\circ}0' \text{ Calc Orig}}{52.0 \text{ Calc Orig}}$	$\frac{270^{\circ}0' \text{ Orig}}{545.33 \text{ Orig}}$	$\frac{270^{\circ}0' \text{ Orig}}{146.215 \text{ Bal}}$	$\frac{270^{\circ}0' \text{ Orig}}{215.427 \text{ By Addn}}$
--	--	--	--

NOTE : The term "Bal Orig", "Bal by Addn" are not used.

1.47.2 Original distances to be converted to metric are to be shown to three decimal places.

See also "CONVERSIONS" 1.19

See also "METRIC DOCUMENTATION" 1.43.7

1.47.3 When utilising original information, an endorsement is required stating the source of this information.

Sample

Original information compiled from plan SL1234 in Dept A.

OR

from MP10537 in Dept B., Brisbane.

When a number of plan sources are used for original information, the statement is as follows:

Sample Original information compiled from plans RP213546 and CP808763 in Dept A. and from MP10537 in Dept B., Brisbane.

1.47.4 The word "Original" is not shown on Section 25 compiled plans.

See also "DIMENSIONS" 1.27

See also "DISTANCES" 1.28

See also "METRIC DOCUMENTATION" 1.43

See also "WATERCOURSES" 1.69

1.48 Parish Boundary

Sample

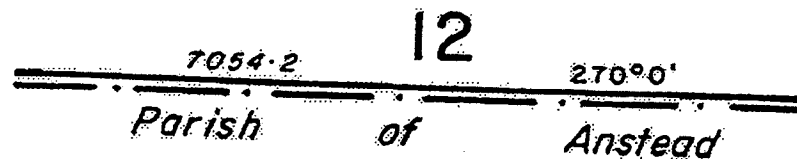

Show outside subject block and as close to line as possible. Parish boundary is never broken by dimensions.

Subject to same conditions as "COUNTY BOUNDARY" 1.22

See also "LINEWORK" 1.38.10

1.49 Plan Forms

1.49.1 For surveys to be lodged in Dept B. the official Dept B. plan form shall be used.

See also "PLAN " Part E4

1.49.2 For cadastral surveys to be lodged or deposited with Dept A. the current version of the official plan form shall be used (Form 21). The plan should be identified with a pre-numbered barcode label.

See also - 1.4 "ADJOINING DESCRIPTION"

See also - 1.24 "DATUM"

See also - "DEPT A REQUIRMENTS" E3-18. Plan forms

1.49.3 Availability

Barcodes can be purchased from:

Secretary, Association of Consulting Surveyors
1st Floor, Silverton Place 101 Wickham Terrace
BRISBANE QLD 4000

Phone: (07) 3831-6668

Fax: (07) 3832 6398

For Dept B:

Plan forms can be purchased from:

Department of Mines & Energy
GPO Box 194
BRISBANE QLD 4001

1.50 Plotting

Plans shall be accurately drawn to scale to within a minimum of 1 part in 150.

The co-ordinate system of accuracy control should be used where necessary to achieve the required standard.

See also "SCALE OF PLANS" 1.58

1.51 Proclaimed Survey Areas

PSA's should be identified by statement on the face of the plan directly above the Title Block.

See also Dept A. Requirements E3-11.12 Proclaimed Survey Areas

1.52 Ranged Only And Reads Bearings

Show as follows:

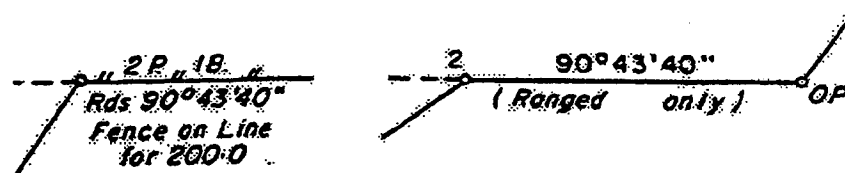
Sample

See also "CONNECTIONS TO DISTANT POINTS" 1.17

See also "FENCES" 1.31

1.53 Reserved Esplanade

1.53.1 The landward boundary of the esplanade is fixed at the time of survey for a Deed of Grant to issue.

1.53.2 The seaward boundary is subject to accretion and erosion.

See also "ROADS" 1.57

See also "AMBULATORY BOUNDARIES" Dept A. Reqmts E3-6.4

1.54 Reserved Roads

Reserved Roads & Esplanades either surveyed or unsurveyed, are shown on the face of the plan in a specific location and are also shown as being excluded from the parcel on the face of the plan.

Sample

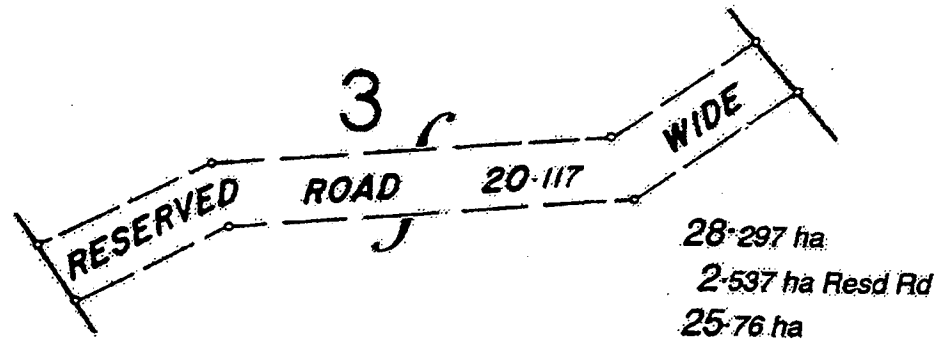

See also "AREAS" 1.8

See also "ROADS" 1.57

See also "RESERVED ROADS & ESPLANADES" Dept A. Reqmts E3-10.4

1.55 Resurvey

When a resurvey is carried out with a view to correction of or issue of title or instrument of lease, the normal plan requirements shall apply.

The title of the plan shall be :

*Eg. Lot 15, being Resurvey of Lot 15 on RP135694
Cancelling Lot 15 on RP135694.*

See also "DEPT A." EXAMPLE PLAN No 25

See also "DEPT B. REQUIREMENTS" E2-3.10 Identification Survey

See also "RESURVEY" Dept A. Requirements E3-11.3 Resurveys & 9.4.4 Resurveys

1.56 Road Reservation

A Road Reservation does not have a specific location within a lot and is State Land reserved from the title.

Areas shall be shown on plans as follows:

Sample

36.635 ha

3.075 ha Rd Resn

33.56 ha

(Title issues on the Nett area of the Lot only.)

See also "AREAS" 1.84

See also "RESNS IN TITLE" Dept A. Requirements E3-10.7 & 1.5

1.57 Roads

1.57.1 The present name of Roads, Streets and Esplanades shall be shown and be in accordance with the relevant Local Authority nomenclature.

- 1.57.2** Refer to Main Roads Gazette for correct HIGHWAY and MAIN ROAD name.
- 1.57.3** Where only one side of road has been surveyed, calculated distances on unsurveyed side are not normally shown.
- 1.57.4** Esplanades are shown and treated in the same manner on plans as for roads.
See also "RESERVED ESPLANADE" E3-10.4 & 10.9
- 1.57.5** Dimensions and widths for internal roads are shown for complete blocks. Use "Orig" where applicable.
- 1.57.6** For roads forming boundaries of subject blocks, the width, when opposite side is shown must be indicated and plotted to scale;
Eg. ROAD 60-35 WIDE
- 1.57.7** For roads in an unsurveyed state see DEPT A. Example Plan No 6.
See also "DIMENSIONS" 1.27.3 and E3-11.6
See also "DEPT A. EXAMPLE PLANS Nos 26 -- 32"
See also "DEPT B. REQUIREMENTS" E2-3.16
See also "ROADS/RAILWAYS" Dept A. Requirements E3-10

1.58 Scale Of Plans

- 1.58.1** Plans shall be drawn accurately to a scale that will allow all details and annotations being clearly shown on an A4 second generation copy of the original. This requirement should assist in determining the selection of the appropriate plan scale.
- 1.58.2** A complete plot of the subject block or blocks is drawn on the plan in an uninterrupted manner to the scale as shown in the Title.
- 1.58.3** Diagrams drawn either
- to another suitable scale; and/or
 - Not to scale' may be used for clarification.
- 1.58.4** It is suggested that plans and diagrams be drawn to one of the following scales, or multiples to the power of 10 thereof:

Suggested Plan Scales			
1:1	1:2	1:4	1:7.5
1:1.25	1:2.5	1:5	1:8
1:1.5	1:3	1:6	

- See also "NOT TO SCALE" 1.45
See also "PLOTING" 1.50
See also "SCALES & SCALES RATIOS" E3-20.2.9 & 20.2.10

1.59 Secants

Dimensions of secants are shown "on face" or tabulated in the "TRAVERSES ETC" column.

See also "DIMENSIONS" 1.27

See also "LINEWORK" 1.38.7

See also "TABULATIONS" 1.66

See also "TRAVERSES" 1.67

1.60 State Boundary

Sample

31

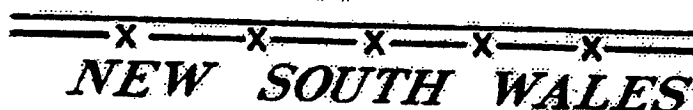

See State Boundary Agreement Act, 1983.

Subject to same conditions as "COUNTY BOUNDARY" 1.22

See also "LINEWORK" 1.38.12

See also "ADMINISTRATIVE BOUNDARIES" Dept A Requirements E3-2.1

1.61 Station Numbers

Station numbers are to be shown upright in as simple a format as possible. ie. 1,2,3, with 1a, 1b etc. for secants and close proximity work only.

Adequate station numbers should be shown on the plan to describe survey lines, qualify action statements and other "on face" statements.

See also Dept A SPECIMEN PLANS Nos 1, 2 and 3

1.62 Styles

1.62.1 The use of mechanical guides and computerised drafting equipment will produce styles that may vary from those shown in this segment. The use of this equipment to produce plans is acceptable provided -

- That the end result displays the information in a clear and concise manner.
- That variable pen sizes, lettering heights, etc. are used to indicate the information in an unambiguous manner, attempting to demonstrate the guidelines contained within the pages of this manual.

- That the plan can be reproduced at a reduced scale to enable microfilming to take place.

See also "INK" Part E2-1.34

See also Dept A Specimen Plans 1, 2 and 3

See also Dept B Speciment Plan 1

- 1.62.2** Subject Lot, Mining Tenure (where used as legal property descriptions), Easement, Island and Diagram.

Sample

ABCDEFGHIJKLMN OPQRSTUVWXYZ
1234567890

- 1.62.3** Adjoining Style of 1.62.2 above and their catalogue numbers. Adjacent (non-adjointing) Road, Street, Railway, Channel & Drainage Area. All distances and all column headings and entries. Statements & Endorsements. Corner Information, Plan Title (where applicable), Features (Gully, Bldg, 2B 1P fence etc), Read and Ranged Only Bearing, Area (right of decimal).

Sample

ABCDEFGHIJKLMN OPQRSTUVWXYZ
1234567890 *abcdefghijklmnopqrstuvwxy*z

- 1.62.4** Subject Road, Street, Lane, Pathway, Drain and Channel Area, Railway, Highway, Expressway, Freeway and Plan Title (where applicable).

Sample

ABCDEFGHIJKLMN OPQRSTUVWXYZ
1234567890

- 1.62.5** Subject Bay, Sea, Ocean, River, Creek. Area (left, of decimal), Plan Title (where applicable), Adjoining State eg. N.S.W

Sample

ABCDEFGHIJKLMN OPQRSTUVWXYZ
1234567890 *abcdefghijklmnopqrstuvwxy*z

- 1.62.6** Adjacent (non-adjointing) River, Parish Name (Upper and Lower Case), Bay, Ocean, Sea

Sample

ABCDEFGHIJKLMN OPQRSTUVWXYZ

- 1.62.7** Adjoining County Name, Adjoining or Internal Creek NOTE: For Capitals use style 1.62.6

Sample

*abcdefghijklmnopqrstuvwxy*z

- 1.62.8** Subject Holding, Parish Name on face (when applicable).

Sample

ABCDEFGHIJKLMN**OP**QRSTUVWXYZ
1234567890 abcdefghijklmnopqrstuvwxy

- 1.62.9** All bearings (except Column entries and Reads), Station Numbers

Sample

1234567890 abcdefghijklmnopqrstuvwxy

- 1.62.10**
- Lapsed Lease description for Dept B. PLANS ONLY
 - Previous property descriptions on face when entire parcels have disappeared as a result of State Resumptions for new Road, Rly etc for Dept A plans only.

Sample

A B C D E F G H I J K L M N O P Q R S T U V W X Y Z
1 2 3 4 5 6 7 8 9 0

1.63 Survey Records

When additional data is lodged in support of the survey eg. creek traverse offsets, this information shall be indicated in the appropriate box on the face of the plan.

ie. *YES/NO* SURVEY RECORDS DEPOSITED

If survey records for a number of plans are in the one book, one plan number should be chosen to be shown on the front of the Field Book and on the front of each plan in the Survey Records Box.

Where the reinstatement of a survey is complex or there are significant differences from either original or other surveys, a report in a Field Book cover should be lodged with the plan.

Where the present definition of High Water Mark (HWM) differs significantly from original HWM, a report in a Field Book cover should be lodged with the plan.

See also Dept A Requirements E3-11.4 Survey Records
See also Dept B "FIELD NOTES" E4-3.8

1.64 Surveys In Strata

1.64.1 Parcels of land with height or depth restrictions shall be fully defined on the face of the plan and shall be described as Lot..... (In Strata) or Proposed Easement..... (In Strata) in the Title Block.

1.64.2 If a Lot or Easement being created or cancelled has a depth or height restriction, that Lot or Easement shall be described as "In Strata" ie Lot 6 (In Strata), Proposed Emt A (in Strata) in the Title Block. The full depth or height restriction information shall be shown on the face of the plan.

Heights shall be in terms of the Australian Height Datum and be referred to a Permanent Survey Mark of known Reduced Level which is stated on the face of the plan and connected if applicable.

See also Dept A EXAMPLE PLANS Nos 12, 13, 37, 38

See also Dept B "DEPTH RESTRICTIONS" E4-3.12.5

See also Dept A Requirements E3-21 Easements & E3-25 Volumetric Format Plans.

1.65 Symbols

ADIT 

ASTRONOMICAL STATION 

BENCH MARK ● B.M. Number

BINDER (VINCULUM)  

BORE ● Bore

BORE & DRAIN 

BRIDGE & CULVERT 

BROAD ARROW 

BUILDING  (Approx. Shape & Descriptn)
U/Set Brick

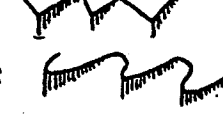
CLIFF or ESCARPMENT (traversed) OR 

CREEKS & RIVERS 

(not traversed) 

CUTTING 

DAM 

EMBANKMENT or STEEP BANK 

FENCE on Boundary 

Internal 

GRAVEL PIT 

GULLY 

HORIZONTAL CONTROL POINT 

LAKE or LAGOON		ROAD OVERBRIDGE	
LIGHTHOUSE		ROCKY FORESHORE	
MANGROVES		SAND	
MINING DISTRICT		SCRUB or TIMBER RIDGE	
MINING FIELD		SHAFT	
OBSERVATION STATION		SUBWAY UNDER RAILWAY	
PEAK		SURVEY STATION	(Small circle with number)
PERMANENT MARK		SWAMP	
PERMANENT WATER HOLE		TANK (earth)	
PHOTOGRAMMETRIC CONTROL POINT		TELEPHONE and TELEGRAPH LINE	
POWER LINE		TIMBER RIDGE	
QUARRY		TRACK	
RAILWAY SINGLE TRACK		TRONOMETRICAL STATION	1st & 2nd order 1400 3rd & 4th order 1210
RAILWAY DOUBLE TRACK		TUNNEL	
RANGE or RIDGE		VERTICAL CONTROL POINT Cadastral Traverse Permanent Mark Bench Mark
RETAINING WALL			

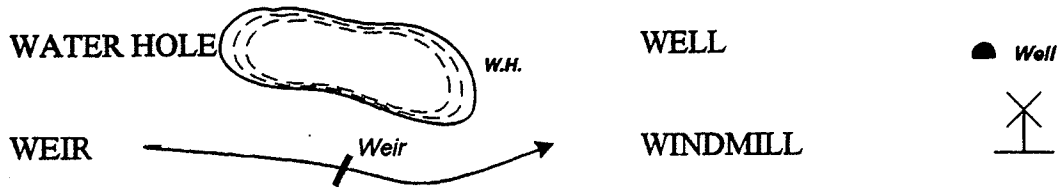

1.66 Tabulations

When a plan has been 'turned', tabulations are to be treated likewise so as to facilitate easy reading of plan.

See also "CORNER INFORMATION" Diag. B

See also "NORTH POINT & DATA ORIENTATION" 1.44

See also "TRAVERSES" 1.67

See also "NORTH POINT" Dept A Requirements E3-19.11

1.67 Traverses

1.67.1 Extraneous field traverse information is generally not shown.

1.67.2 When traverse lines are shown, dimensions are shown on face or tabulated in the "TRAVERSES ETC" column.

When tabulation is adopted, numerical order is preferred.

Sample

TRAVERSES ETC		
LINE	BEARING	DIST
1 - 2	180° 07'	13.13
3 - 4	236° 43' 30"	105.26
5 - 5a	355° 32' 40"	20.117

1.67.3 Where a traverse has been run to establish a new boundary along an inaccessible tract (cliff, etc.) the traverse is shown in the normal manner and the boundary shown calculated.

Vide Section 24 of the Surveyors Regulation 1992.

See also "DATUM" 1.24.1

See also "LINEWORK" 1.38.7

See also "OFFSETS" 1.46

See also "WATERCOURSES" 1.69.2

1.68 Vinculum

- 1.68.1 Vincula 'bind' two or more land segments, separated by road, railway etc, to form a single tenement which is usually designated by one property description.
- 1.68.2 Tenure issues on the "NETT" area only.

Sample

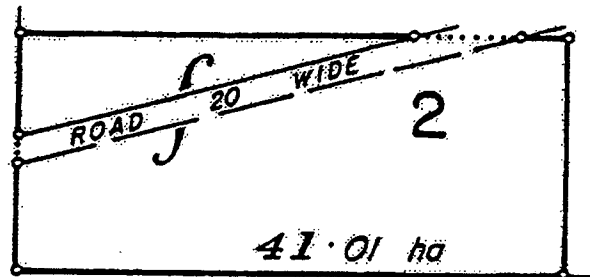

See also "AREAS" 1.8.1 Calculated & 1.8.2 Multiple Line Areas

See also "Dept B REQUIREMENTS" E4-3.21

See also "Dept A REQUIREMENTS" E3-11.17

See also "LOCAL GOVT AGREEMENTS" Dept A Reqmts E3-3.3.2

See also "DIMENSIONS" 1.27.3

1.69 Watercourses

- 1.69.1 Show opposite bank of watercourse if practicable. It is not always necessary, however, to show information on the other side of watercourse forming boundaries except for adjoining Parish and County names.

Sample

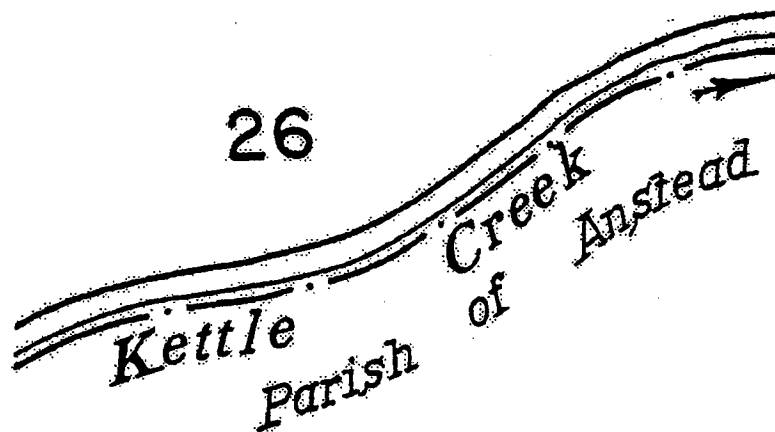

- 1.69.2 Distances on the boundary terminating at a watercourse are to include distance to:
- Post or Peg.
 - Traverse.
 - Bank or Watercourse Boundary (Ck, Riv, etc).

Sample

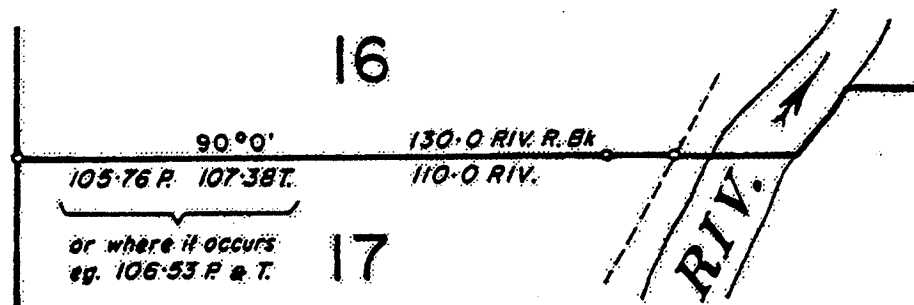

- 1.69.3 Survey records must be lodged showing the watercourse traverse, measurements to the bank and area calculations.
- 1.69.4 An arrow indicating "downstream" ONLY must always be shown.
- 1.69.5 While traverses of watercourses are to be indicated on plan when run, there is no necessity to show when original. The original catalogue number shown along the watercourse will suffice.
- 1.69.6 Where original traverses of watercourses are used to obtain a new area of a lot, it is required that the original traverse dimensions be shown on the plan.

A statement indicating origin of original offsets is also to be shown.

For cases involving vast original traverse data, the original plan number shown along the watercourse boundary will suffice, provided survey records are lodged.

See also "AMBULATORY BOUNDARIES" Dept A REQMTS E3-6

1.70 Watersheds

When "WATERSHED" is the boundary, the following guidelines should apply:

- 1.70.1 Unsurveyed Watershed

Sample



1.70.2 Surveyed Watershed

1.70.2.1 Eg.

Sample

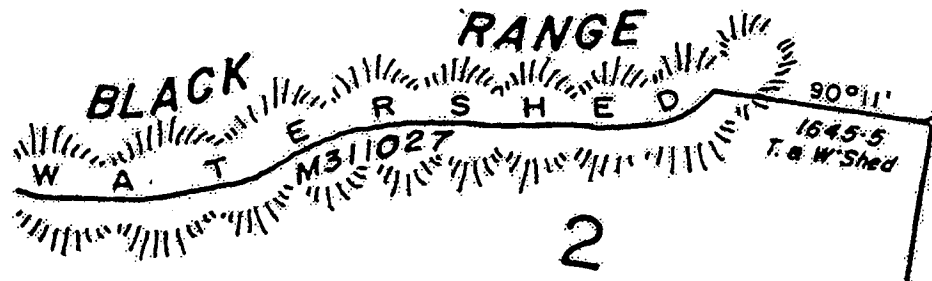

1.70.2.2 If traverse lines have been adopted as the boundary and corners have been marked, then right lines are shown.

Sample

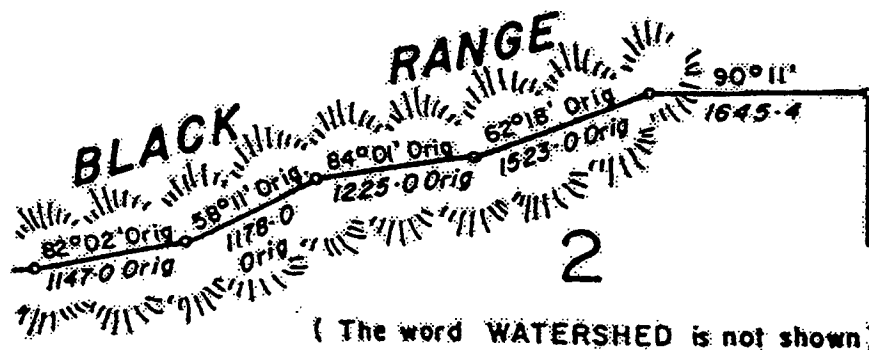

1.70.3 If in doubt as to which of the above methods is to be used, a search of the original tenure document should be made.

1.70.4 Relevant boundaries are labelled "COMPASS SURVEY" as required.
See also "COMPASS SURVEY" 1.15

This page intentionally left blank.

Department of Natural Resources

➤ SPECIMEN PLANS

➤ EXAMPLE PLANS

General:

Specimen Plans Nos 1, 2 & 3 are models of the desired survey plan format and presentation that should be adopted when preparing plans for deposit and registration in the Department of Natural Resources.

Example Plans Nos 1 to 39 are examples of the actions necessitating lodgement of cadastral plans in the Department of Natural Resources

The majority of the examples are copies of original plans held in Dept A which have been suitably adapted to represent specific actions. As such, these examples may not necessarily conform in every respect to all guidelines stated in this manual.

The Specimen and Example Plans have not been allocated page numbers.

The requirements of Dept B (Mines & Energy) commence at E2-131

The Examples Plans have been drafted by Benchmark Drafting Pty Ltd of PO Box 6462, Upper Mt Gravatt, 4122, Geoff Gebhard (07) 3849-5597.

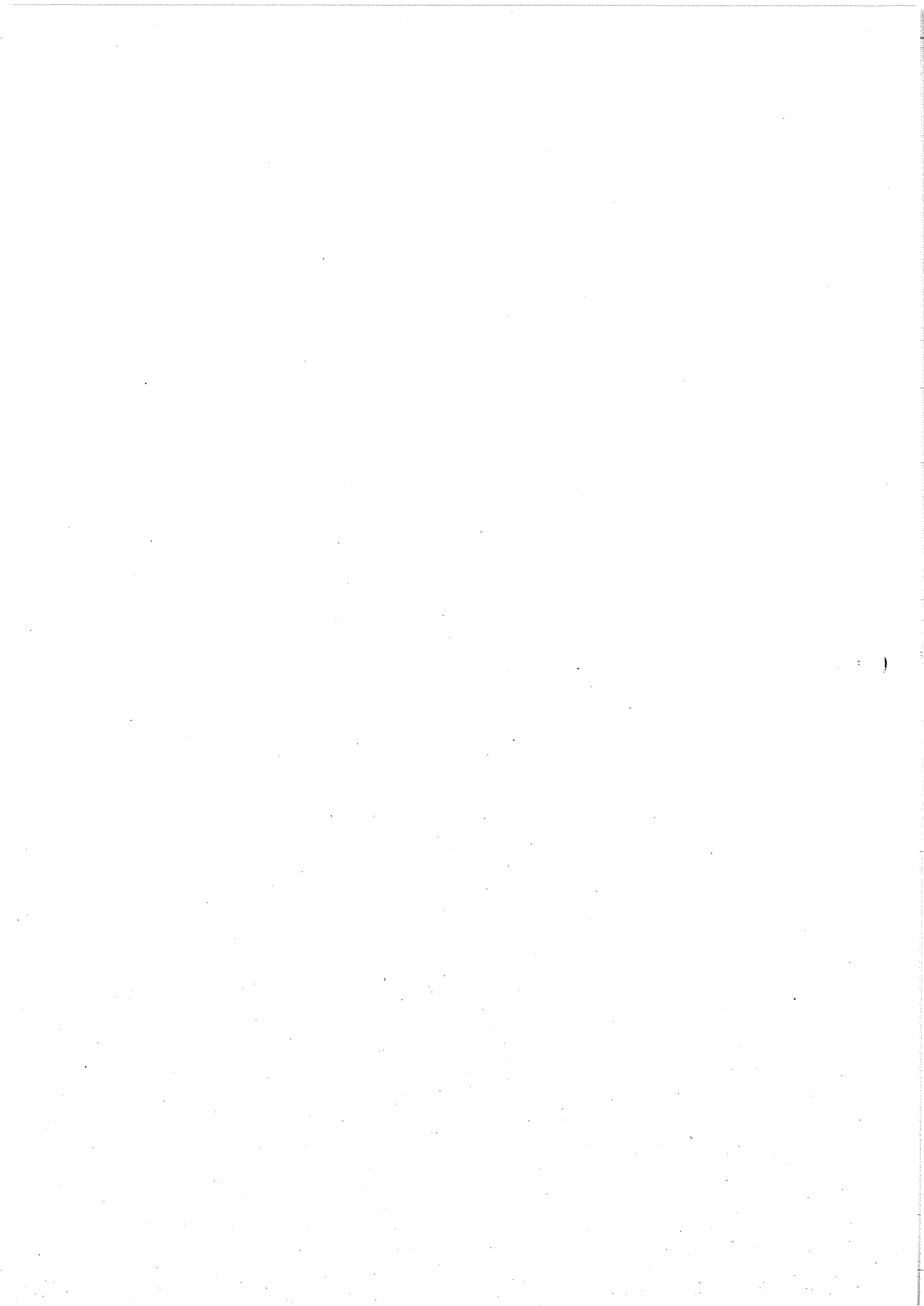

Item	Section
A Addition of unallocated Stateland	
vacant Land to F/Hold Consolidated Title	Example Plan No 3
reclaimed Land to F/Hold or L/Hold	Example Plan No 2
Road Closure To F/Hold or L/Hold	Example Plan No 1
C Channel - See Channel/Drain	Example Plan No 4
Compiled Plans	-
surveyed Parcel	Example Plan No 5
unsurveyed Parcel (located)	Example Plan No 7
unsurveyed Parcel (isolated)	Example Plan No 8
large unsurveyed Parcel	Example Plan No 6
Creek Traverse	Example Plan No 9
State Resumptions In F/Hold Land (main Road, Railway, Channel Etc) - Treat as normal plan of subdivision describing the resumed area as a lot.	
D Depth Restrictions (title To Varying Depths)	Example Plan No 10
E Easement Affected By Survey Action	Opposite Example Plan No 11
Easement Proposed	-
with Height Restriction	Example Plan No 12
in B.U.P. With Height Restriction	Example Plan No 13
Esplanades - Unsurveyed	Example Plan No 14
Excision	Example Plan No 15
G Group Title Plan	Example Plans Nos 18 & 19
I Identification Surveys	Example Plans Nos 16 & 17
L Leases	
in State Reserves	Plan No 21
in Vested Areas	Plan No 22
on Registered Plan Form	Plan No 20
of Part of A Building	Example Plan No 35
of Part of A Lot	Example Plan No 34
M Main Road Resumption In F/Hold Land - treat as normal plan of subdivision describing the resumed area as a lot.	
P Photogrammetric Survey	Example Plan No 23

Item	Section
R Railway In State Land.....	Example Plan No 24
Railway In F/Hold Land - treat as normal plan of subdivision describing the resumed . area as a lot.	
Restricted Titles (subdivisions In Strata)	Example Plan Nos 37, 38
Resurvey.....	Example Plan No 25
Road Closure	
addition To and Amalgamation Of Freehold Tenure	Example Plan No 26
addition To Undescribed Railway.....	Example Plan No 27
involving Criss Crossing of Old & New Roads.....	Example Plan No 28
Road Opening	
noticeable Erosion In Watercourse Boundary.....	Example Plan No 29
noticeable Accretion In Watercourse Boundary.....	Example Plan No 30
Main Roads Resumption In State Tenure	Example Plan No 31
Main Roads Requirements In Undescribed Railways	Example Plan No 32
S Section 5.8.3 Agreements (Local Govt - Planning & Environment Act.....	
.....	Example Plan No 33
Sketch Of Lease Of Part Of Building	Example Plan No 35
Sketch Of Lease Of Part Of Lot.....	Example Plan No 34
Specimen Plans Nos 1, 2 and 3	
Sub Leases In State Tenure.....	Example Plan Nos 37, 38
T Tenure In Strata.....	Example Plan Nos 37, 38
U Unmarked Lines & Corners	Example Plan No 39

Note:The Specimen and Example Plans have not been allotted page numbers.

Survey Plan Guidelines

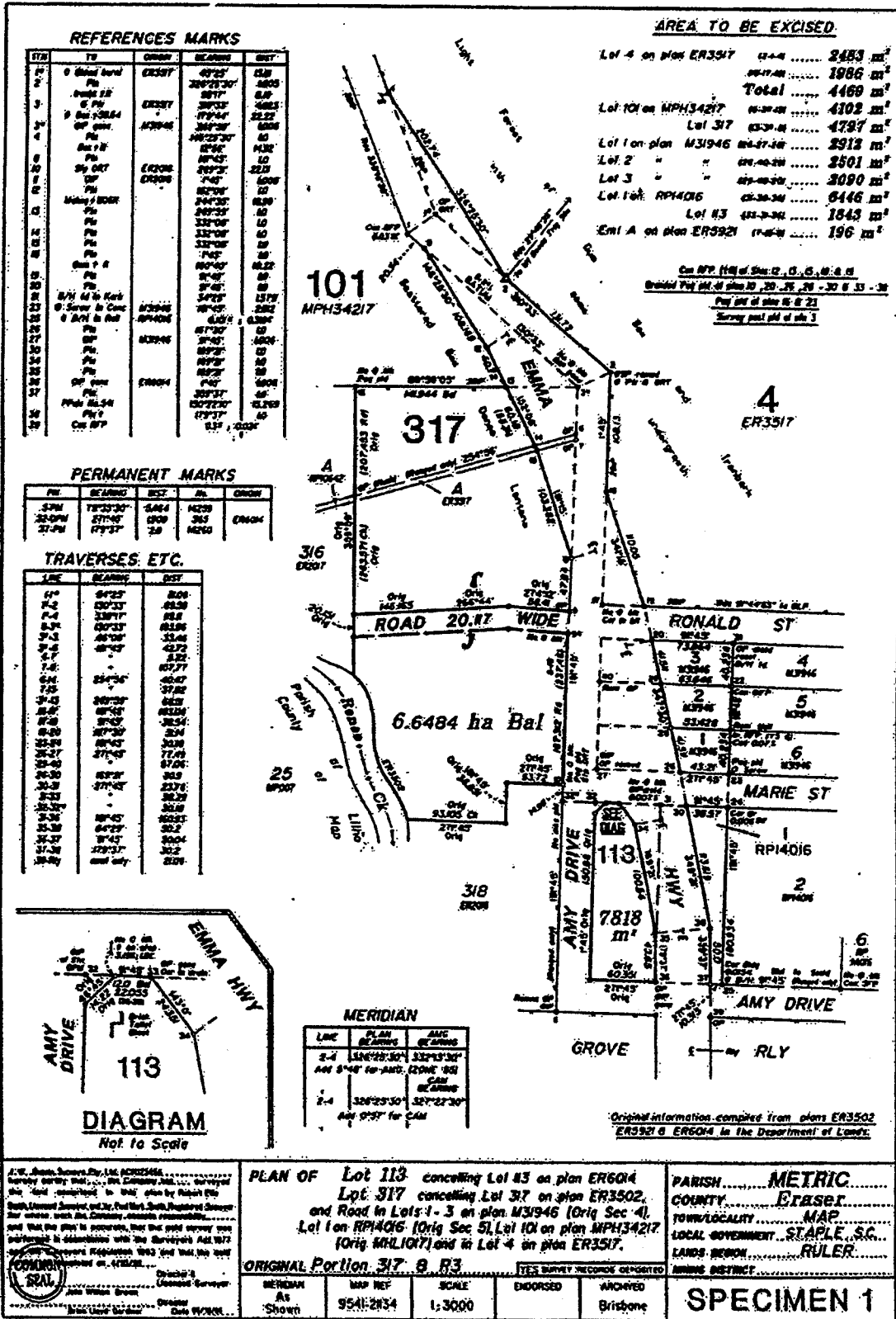

Survey Plan Guidelines

<p style="text-align: center;">(Dealing No.)</p>	<p>Lodged by</p> <p><small>Include address, phone number and reference</small></p> <p>Particulars entered in the Register on the Titles listed below.</p>																																			
<p><small>1/We</small></p> <p>(Names in full)</p> <p>* As Registered Owner of this land * As Lessee/s of Miners Homestead agree to this Plan, and dedicate the Public Use Land as shown hereon in accordance with Section 50 of the Land Title Act 1994.</p> <p>Signature of * Owner/s * Lessee/s</p>	<table border="1" style="width: 100%; border-collapse: collapse;"> <thead> <tr> <th>Title Reference</th> <th>Description</th> <th>New Lots</th> <th>New Road</th> <th>Easements</th> </tr> </thead> <tbody> <tr> <td>B74021A</td> <td>Lot 2, on RP22065</td> <td>5, 6</td> <td>New Road</td> <td>A</td> </tr> <tr> <td></td> <td>Lot 4, on RP22065</td> <td>1, 4</td> <td>New Road</td> <td>A</td> </tr> <tr> <td>B74023</td> <td>Lot 1st, RP22065</td> <td>7, 8</td> <td>New Road</td> <td></td> </tr> </tbody> </table> <table border="1" style="margin-left: auto; margin-right: auto; border-collapse: collapse;"> <thead> <tr> <th colspan="2">PORTION ALLOCATION</th> </tr> <tr> <th>Lots</th> <th>Portion</th> </tr> </thead> <tbody> <tr> <td>1 - 6</td> <td>292</td> </tr> <tr> <td>7 & 8</td> <td>292 & 293</td> </tr> <tr> <td>9, 10 & 11</td> <td>293</td> </tr> </tbody> </table>	Title Reference	Description	New Lots	New Road	Easements	B74021A	Lot 2, on RP22065	5, 6	New Road	A		Lot 4, on RP22065	1, 4	New Road	A	B74023	Lot 1st, RP22065	7, 8	New Road		PORTION ALLOCATION		Lots	Portion	1 - 6	292	7 & 8	292 & 293	9, 10 & 11	293					
Title Reference	Description	New Lots	New Road	Easements																																
B74021A	Lot 2, on RP22065	5, 6	New Road	A																																
	Lot 4, on RP22065	1, 4	New Road	A																																
B74023	Lot 1st, RP22065	7, 8	New Road																																	
PORTION ALLOCATION																																				
Lots	Portion																																			
1 - 6	292																																			
7 & 8	292 & 293																																			
9, 10 & 11	293																																			
<p><small>* Rule out whichever is inapplicable</small></p> <p><small>* NOTE: A Lessee of a Miners Homestead is unable to dedicate Public Use Land.</small></p> <p>I, _____</p> <p>certifies that all the requirements of this Council, the Local Government Act 1993, the Local Government (Planning and Environment) Act 1990 and all Local Laws, and the City of Brisbane Act 1924 and all Ordinances thereunder, have been complied with and approved this plan of Subdivision, SUBJECT TO</p> <p>Dated this day of, 19</p> <p style="text-align: right;">..... Mayor <small>* Appointed Officer</small></p> <p style="text-align: right;">..... Chief Executive Officer</p> <p><small>* Insert the name of the Local Government</small></p> <p><small>* Delete for Local Governments other than the City of Brisbane</small></p>	<table border="1" style="width: 100%; border-collapse: collapse;"> <thead> <tr> <th style="width: 25%;">SURVEY EXAMINATION</th> <th style="width: 25%;">ORIGINAL GRANT</th> <th style="width: 25%;">CHARTING</th> <th style="width: 25%;">LODGEMENT FEES</th> <th style="width: 25%;">REFERENCES</th> </tr> </thead> <tbody> <tr> <td>Exam Fee \$</td> <td></td> <td>Chk led</td> <td>Survey Exam \$</td> <td>Lands File</td> </tr> <tr> <td>Receipt No.</td> <td></td> <td></td> <td>Local Exam & Ass \$</td> <td>Local Government Reference</td> </tr> <tr> <td>Date</td> <td></td> <td></td> <td>New Titles \$</td> <td>Surveyor's Reference</td> </tr> <tr> <td>Deposited</td> <td></td> <td></td> <td>Photocopy \$</td> <td></td> </tr> <tr> <td>Examined</td> <td></td> <td></td> <td>Postage \$</td> <td></td> </tr> <tr> <td>Passed</td> <td></td> <td></td> <td>TOTAL \$</td> <td style="text-align: center;">PLAN</td> </tr> </tbody> </table>	SURVEY EXAMINATION	ORIGINAL GRANT	CHARTING	LODGEMENT FEES	REFERENCES	Exam Fee \$		Chk led	Survey Exam \$	Lands File	Receipt No.			Local Exam & Ass \$	Local Government Reference	Date			New Titles \$	Surveyor's Reference	Deposited			Photocopy \$		Examined			Postage \$		Passed			TOTAL \$	PLAN
SURVEY EXAMINATION	ORIGINAL GRANT	CHARTING	LODGEMENT FEES	REFERENCES																																
Exam Fee \$		Chk led	Survey Exam \$	Lands File																																
Receipt No.			Local Exam & Ass \$	Local Government Reference																																
Date			New Titles \$	Surveyor's Reference																																
Deposited			Photocopy \$																																	
Examined			Postage \$																																	
Passed			TOTAL \$	PLAN																																

Addition of State Land. (Including Road Closure)

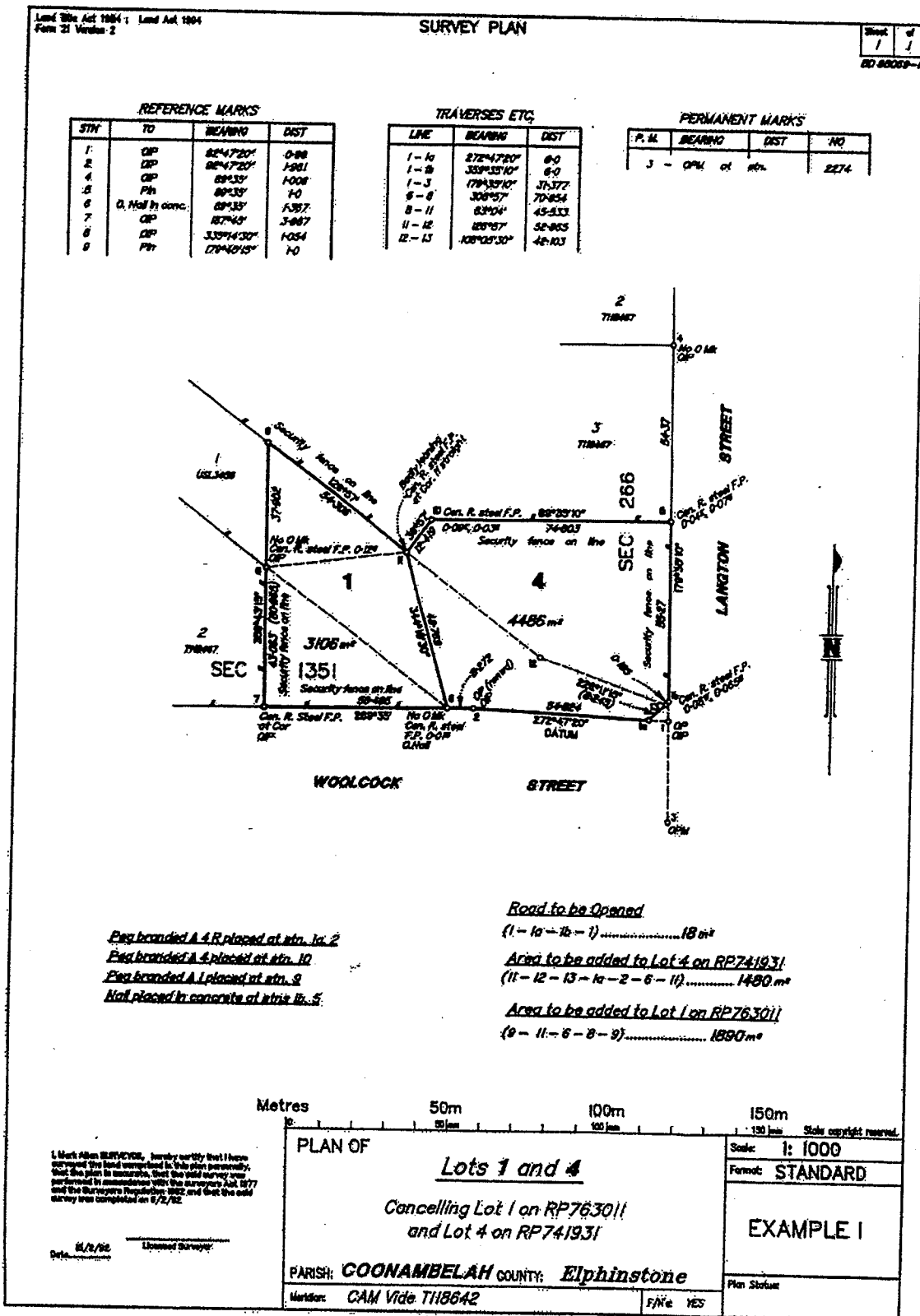

- NOTES:**
1. Action statements on face of plan indicating purpose of survey and full description of land involved
 2. Parcels retain their previous numerical identifier as the new description for the amended lots

Addition of State Land. (Reclamation)

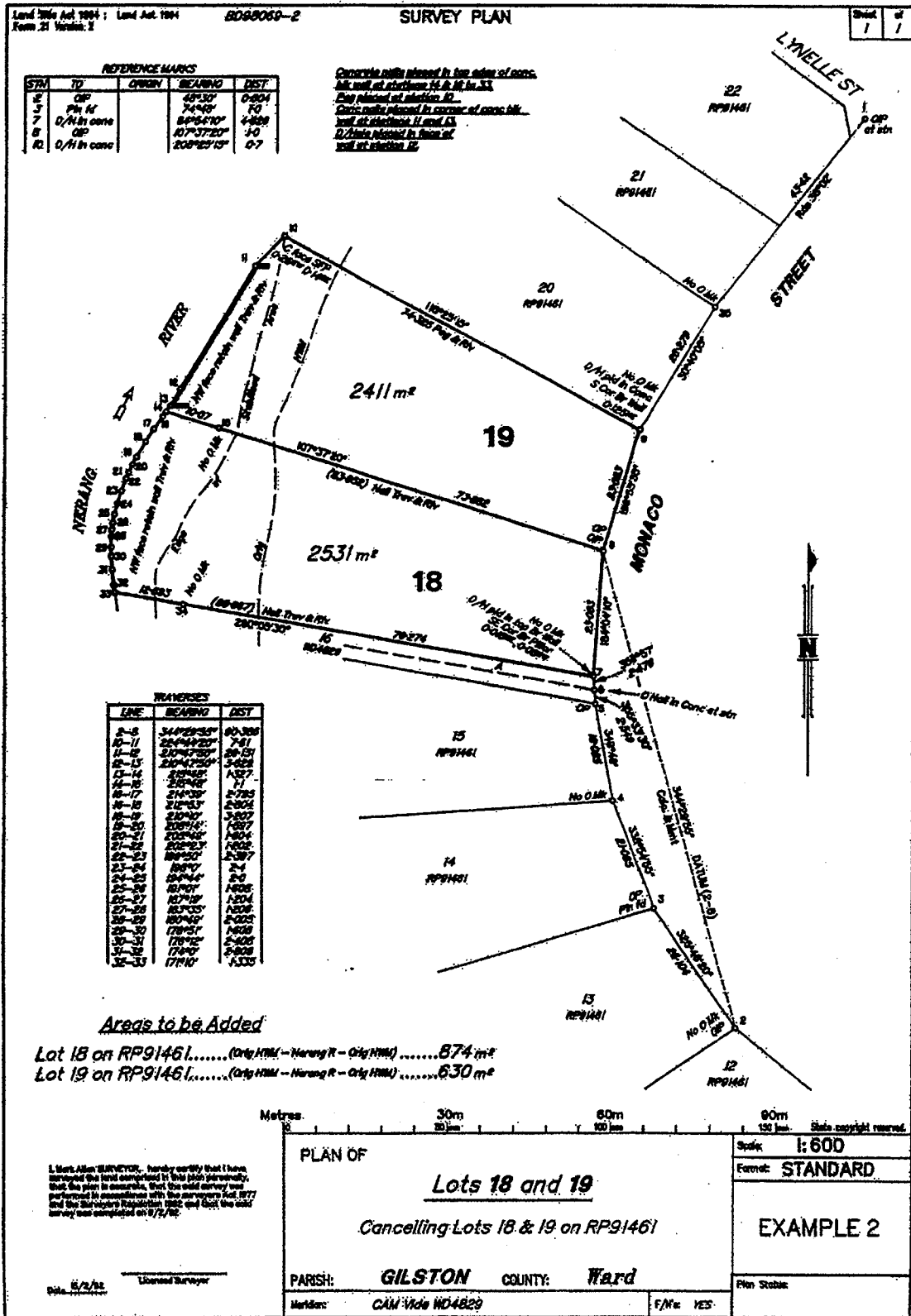

NOTES:

1. Description of areas being added in Action statement and full description of land involved
2. Description of new and original ambulatory boundaries on the plan
3. In this particular instance, the Retaining Wall, River and Traverse are co-incident
4. Parcels retain their previous numerical identifier as the new description for the amended lots

Addition (State Land to Freehold Consolidated Title)

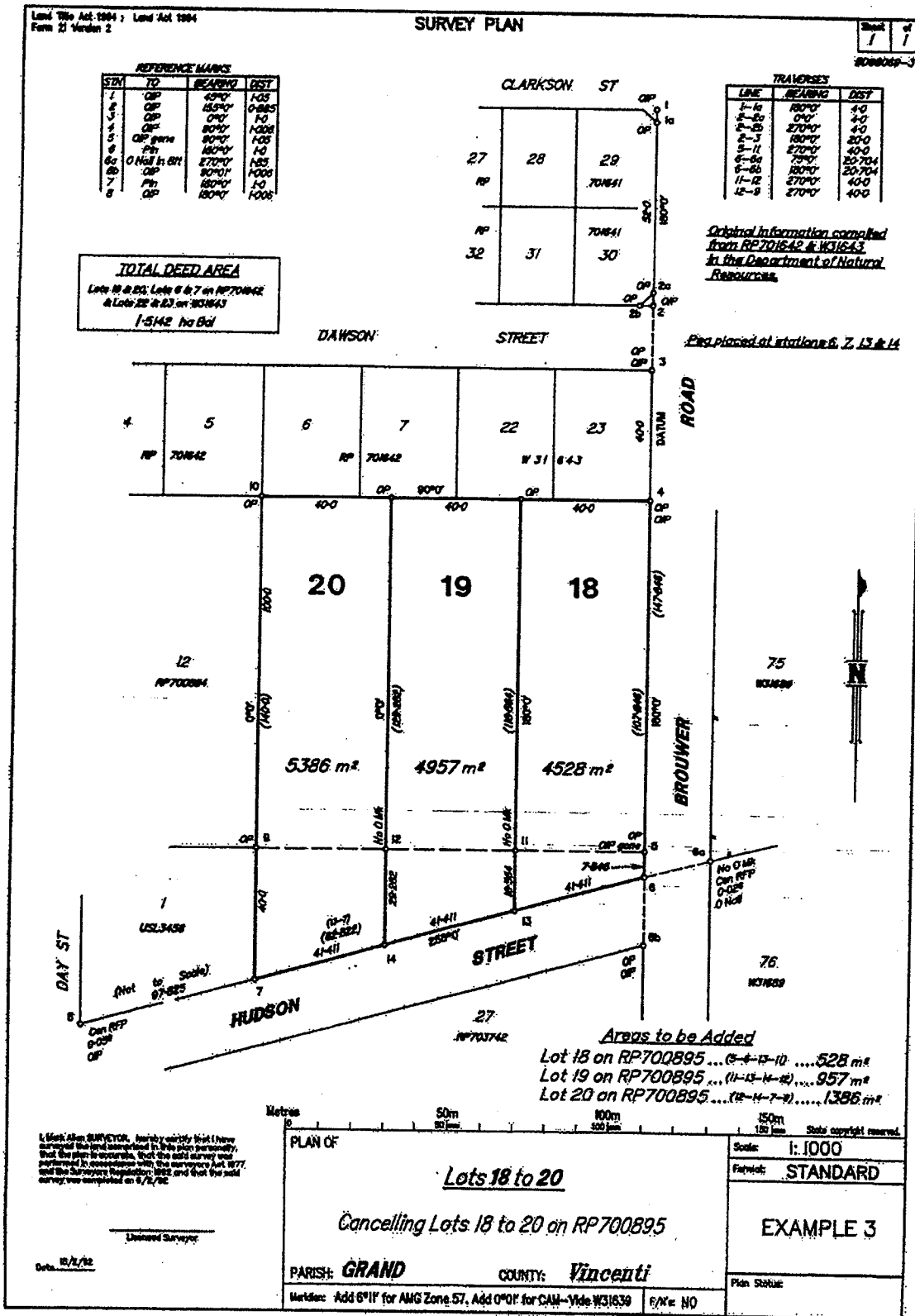

- NOTES:**
- Bordered statement for indicating "TOTAL DEED AREA" (NB. Lot 18 is not part of the consolidated title).
 - Action statements and full description of land involved
 - Parcels retain their previous numerical identifier as the new description for the amended lots

Channel/Drain

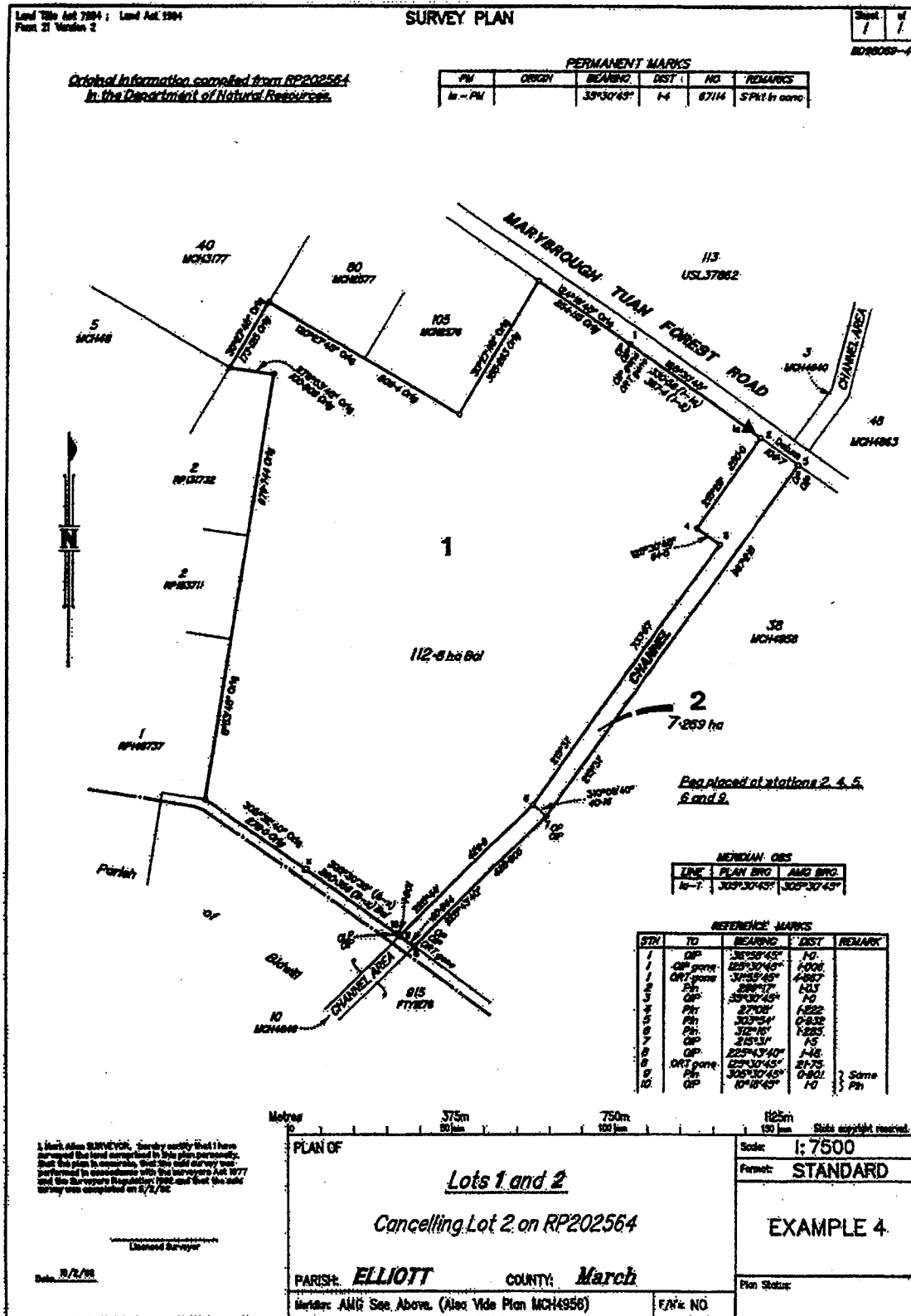

- NOTES:**
1. Channels/Drains are required by the Department of Natural Resources
 2. Channels/Drains are described as such on the face of the plan (Do not designate as Area or Reserve)
 3. Parcels retain their previous numerical identifier

Survey Plan Guidelines

<p>WARNING : Folded or Mutilated Plans will not be accepted. Plans may be rolled. Information may not be placed in the outer margins.</p>																							
<p>(Deed No.)</p>	<p>Registered _____</p> <p>Lodged by _____</p> <p style="font-size: small; text-align: right;">(Include address, phone number, reference, and Ledger Code)</p>																						
<p>1. Certificate of Registered Owners or Lessees.</p> <p>1/We _____</p> <p>(Names in full)</p> <p>* as Registered Owners of this land agree to this plan and dedicate the Public Use Land as shown hereon in accordance with Section 50 of the Land Title Act 1994.</p> <p>* as Lessees of this land agree to this plan.</p> <p>Signature of * Registered Owners * Lessees _____</p> <p style="text-align: center;">AS CONSTRUCTING AUTHORITY THE COMMISSIONER OF WATER RESOURCES APPROVES THIS PLAN OF SUBDIVISION. DATED AT BRISBANE THIS _____</p> <p style="text-align: center;">DAY _____ 1982</p> <p style="text-align: center;">SECRETARY TO THE COMMISSIONER OF WATER RESOURCES</p> <p style="font-size: x-small;">* Fill out whichever is applicable</p>																							
<p>2. Local Government Certificate.</p> <p>* _____</p> <p>Local Government (Planning and Environment) Act 1990, the City of Brisbane Act 1924, and all Local Laws and Ordinances have been complied with subject to _____</p> <p>Dated this _____ day of _____</p> <p style="font-size: x-small;">* Insert the name of the Local Government. Insert designation of signatory or delegation</p>																							
<p>3. Plans with Community Management Statement :</p> <p>CMS Number : _____</p> <p>Name : _____</p>	<p>4. References :</p> <p>Dept File : _____</p> <p>Local Govt : _____</p> <p>Surveyor : _____</p>																						
<table border="1" style="width: 100%; border-collapse: collapse;"> <tr> <td colspan="3" style="text-align: center;"> <p>5. Existing</p> </td> <td colspan="3" style="text-align: center;"> <p>Created</p> </td> </tr> <tr> <td style="font-size: x-small;">Title Reference</td> <td style="font-size: x-small;">Lot</td> <td style="font-size: x-small;">Plan</td> <td style="font-size: x-small;">Lots</td> <td style="font-size: x-small;">Emita</td> <td style="font-size: x-small;">Road</td> </tr> <tr> <td>18000105</td> <td>2</td> <td>RP202584</td> <td>1 and 2</td> <td>-</td> <td>-</td> </tr> </table> <p style="text-align: center;">G808050 Resumption Lot 2 to the Crown.</p> <table border="1" style="width: 100%; border-collapse: collapse;"> <tr> <td style="width: 20%;">Por 69</td> <td style="width: 80%;">1 and 2</td> </tr> <tr> <td>Orig</td> <td>Lots</td> </tr> </table>		<p>5. Existing</p>			<p>Created</p>			Title Reference	Lot	Plan	Lots	Emita	Road	18000105	2	RP202584	1 and 2	-	-	Por 69	1 and 2	Orig	Lots
<p>5. Existing</p>			<p>Created</p>																				
Title Reference	Lot	Plan	Lots	Emita	Road																		
18000105	2	RP202584	1 and 2	-	-																		
Por 69	1 and 2																						
Orig	Lots																						
<p>7. Portion Allocation :</p> <p>a. Map Reference : 9348-33</p> <p>b. Locality : HAUTON</p> <p>10. Local Government : CORAL C.C.</p> <p>11. Passed & Endorsed :</p> <p>By : _____</p> <p>Date : _____</p> <p>Signed : _____</p> <p>Designation : _____</p>																							
<p>12. Building Format Plans only.</p> <p>I certify that :</p> <ul style="list-style-type: none"> * As far as it is practicable to determine, no part of the building shown on this plan encroaches onto adjoining lots or road. * Part of the building shown on this plan encroaches onto adjoining * lots and road <p>Licensed Surveyor/Director * Date _____ *delete words not required</p>																							
<p>13. Lodgement Fees :</p> <table style="width: 100%;"> <tr> <td>Survey Deposit</td> <td style="text-align: right;">\$</td> </tr> <tr> <td>Lodgement</td> <td style="text-align: right;">\$</td> </tr> <tr> <td style="padding-left: 20px;">New Titles</td> <td style="text-align: right;">\$</td> </tr> <tr> <td>Photocopy</td> <td style="text-align: right;">\$</td> </tr> <tr> <td>Postage</td> <td style="text-align: right;">\$</td> </tr> <tr> <td>TOTAL</td> <td style="text-align: right;">\$</td> </tr> </table>		Survey Deposit	\$	Lodgement	\$	New Titles	\$	Photocopy	\$	Postage	\$	TOTAL	\$										
Survey Deposit	\$																						
Lodgement	\$																						
New Titles	\$																						
Photocopy	\$																						
Postage	\$																						
TOTAL	\$																						
<p>14. Insert Plan Number</p> <p style="text-align: right; font-size: large; font-weight: bold;">EXAMPLE 4</p>																							

Compiled Plan (Surveyed Parcel)

NOTES

1. Metes and bounds shall be shown for internal roads, railways etc.
2. For heavily congested plans, metes and bounds need not be shown for internal roads, railways etc. provided all plan catalogue numbers from which this data can be obtained are shown in lieu thereof
3. Plan catalogue number for Creek Traverse to be shown.

Parcel retains its previous numerical identifier as the new description for the amended Lot

Compiled Plan Of Large Unsurveyed Parcel

Pastoral Holding/Grazing Farms

NOTES

1. The name of the Station/Holding to be shown under the Subject Lot Number on the Face of the plan and in the Title Book as a LOCALITY
2. Areas appropriated to relevant Local Authorities to be shown on face.
3. Roads within the Lot, shown as dotted lines on Departmental working maps are by legislation 60 metres wide unless otherwise specified.
4. Roads - surveyed or unsurveyed are to be shown as a series of double straight fines.
5. Statement concerning "Fences to be adopted as boundaries" etc is to be shown if applicable.
6. Plan is compiled by collating the latest available data surrounding the Lot. This may vary from surveyed information to "scaling" and approximating information from published maps, sketches on Dept A Files etc. The plan is NOT drafted purely by tracing or digitizing from a published map.
7. Additional information e.g. Maps, aerial photography, sketches, reports etc. That is used in the compilation process is to be incorporated into the Form 18 certificate for cadastral plans.
8. This type of plan may be the basis for "upgrading" the accuracy of existing mapping.
9. See notes with Example Plan No. 7 for accuracies of Metes and Bounds & Areas.

Unsurveyed parcel (Located)

NOTES

1. There are no strict guidelines for the accuracy of the Metes and Bounds or Areas for unsurveyed Section 25 compiled plans.
2. Bearings, Distances and Areas should be shown to an accuracy which would reasonably reflect the "Control" from which this data is approximated.
3. The following scale of accuracies may be utilized as a guideline when approximating metes and bounds:

BEARINGS	Nearest 0° 15'
DISTANCES	(According to Scale of Plan) -
UP to 1:1250	Nearest 0.5 metres
1:1500 to 1:2500	Nearest 1.0 metres
1:3000 to 1:8000	Nearest 2.0 metres
1:10000 to 1:25000	Nearest 10.0 metres
1:30000 to 1:80000	Nearest 20.0 metres
1:100000 to above	Nearest, 50.0 metres

CLOSE RATIO

It is desirable that a close ratio of not less than 1:2000 be achieved when compiling plans of Lots with unsurveyed boundaries.

Unsurveyed boundaries are shown as broken lines (Abt 12 mm long). Show 'Abt' on bearings and distances. Show 'Abt orig' on successive plans.

4. Generally "Abt" areas are to be shown to no greater accuracy than three significant figures.
5. Parcel retains the most recent numerical identifier as the new description for the amended Lot.
6. Additional information e.g. maps, aerial photography, sketches, reports etc. that is used in the compilation process is to be incorporated into the Form 18 certificate for cadastral plans.

Compiled Plan Unsurveyed Parcel (Isolated)

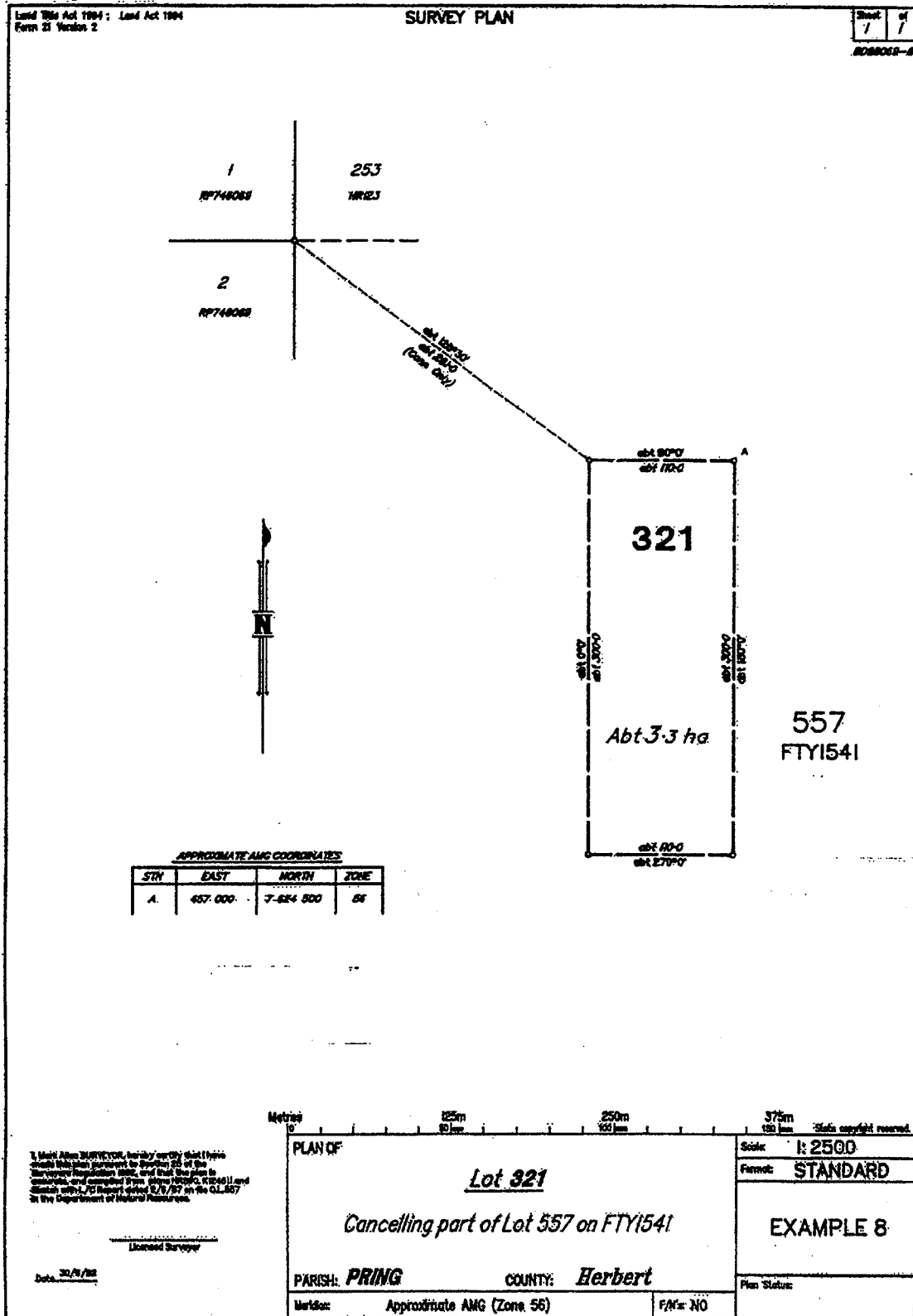

NOTES

1. Connection required to a Cadastral point for "location" of Lot 321 for mapping purposes.
2. Approximate A.M.G. coordinates may be used to "locate" the land parcels
3. Information given in the Surveyor's Certificate is to include all relevant compilation material used e.g. Sketch with Report, Approval, Offer etc. (show date also) and Dept A File Reference
4. See notes for Example Plan No 7 for accuracy of Metes and Bounds and Area.

Creek Traverse (Details from Previous Lot used for New Lot)

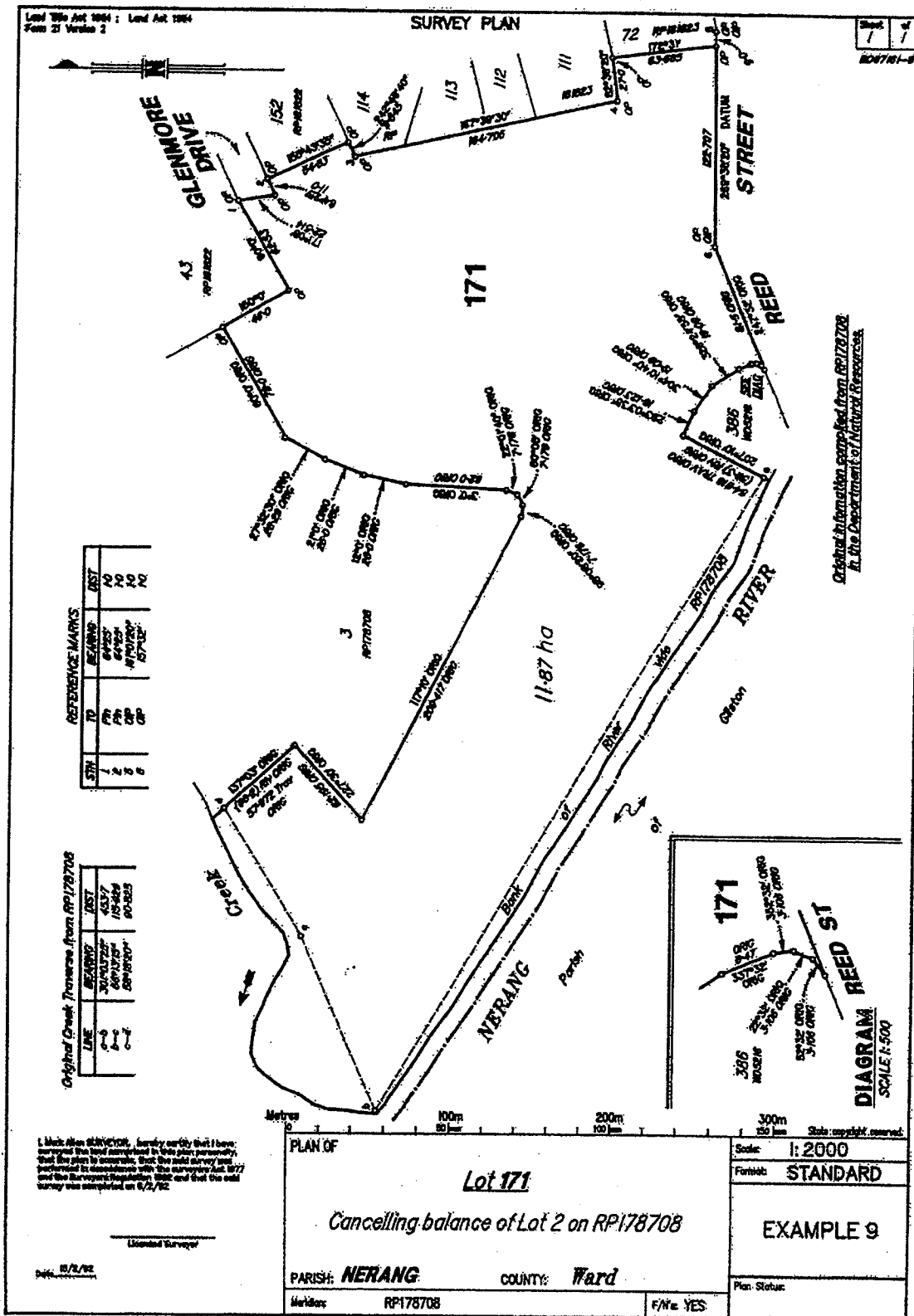

NOTE:

1. Area calculated using creek traverse information from previous plan

Depth Restrictions (Title to Varying Depths)

Land Title Act 1994 : Land Act 1994
Form 27 Version 2

SURVEY PLAN

Sheet 1 of 1
RD99009-10

PERMANENT MARKS			
FM	BEARING	DIST	NO
1-OPM	330°17'	3.315	8084

REFERENCE MARKS			
STM	TO	BEARING	DIST
1	Pin	244°16.3'	0.887
1	O.D./Nails	289°20'	0.704
1	O.Screw in conc	320°28'	0.718
1	R./Nail in conc	290°24'	0.370
1	O.Screw in to conc	348°45'	3.085
1	O.Screw in to conc	308°59'	3.088
2	Pin	348°47'	0.428
2	R./Nail in to conc	348°17'	3.23
3	Pin	244°16.3'	0.887
3	Pin	348°16.3'	2.085
4	O.A. Spike gone	330°17'30"	0.405
4	Pin	289°19'30"	1.009
5	Pin	289°19'30"	0.825
6	Pin	330°17'30"	0.418
6	Pin	330°17'30"	0.417
6	Pin	180°14'30"	1.028
9	OP	270°02'30"	0.804
9	OP (D-4 deep)	330°02'30"	0.853
9	OP (D-3 deep)	30°02'30"	30.177
10	OP	330°04'30"	0.853
11	OP	330°04'30"	0.853
12	OP	330°04'30"	0.853
13	OP	330°04'30"	0.853
14	Pin	270°02'30"	0.804
17	O.A. Spike gone	289°19'30"	0.804
17	OP gone	289°19'30"	0.816
20	Pin	289°19'30"	0.8
21	Pin	289°19'30"	0.8

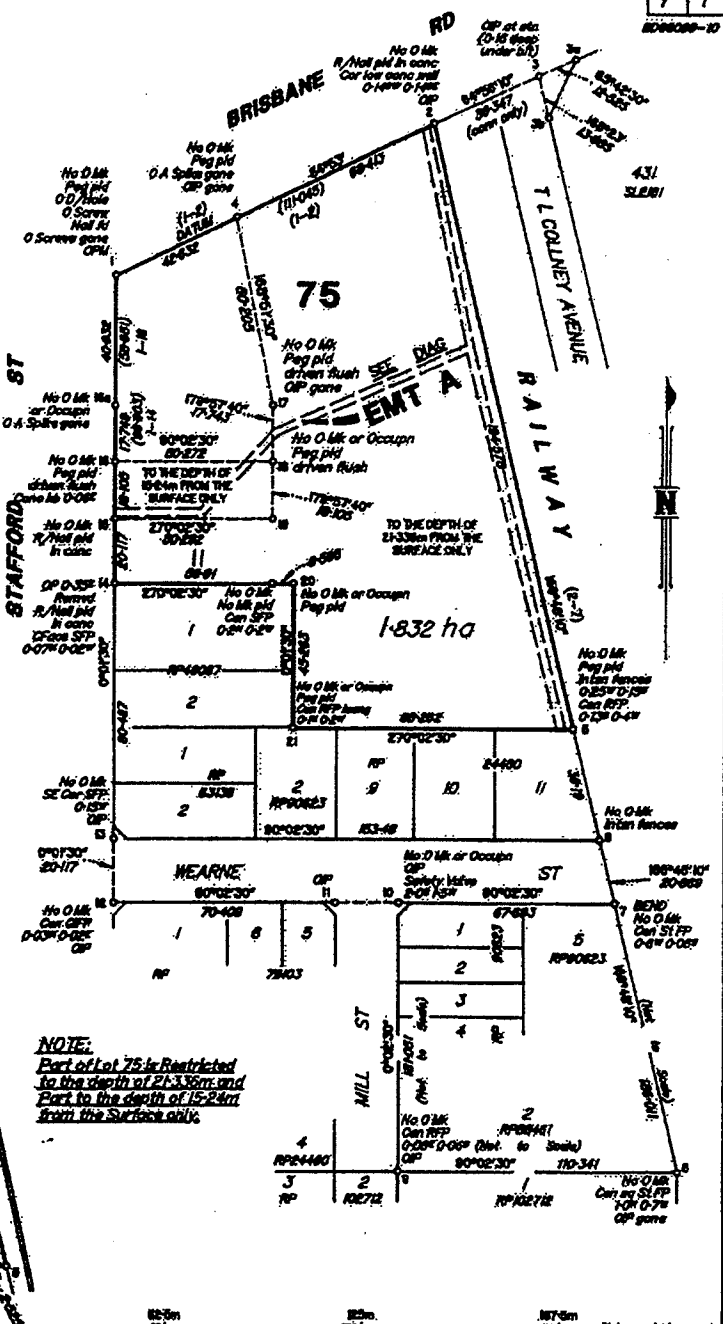
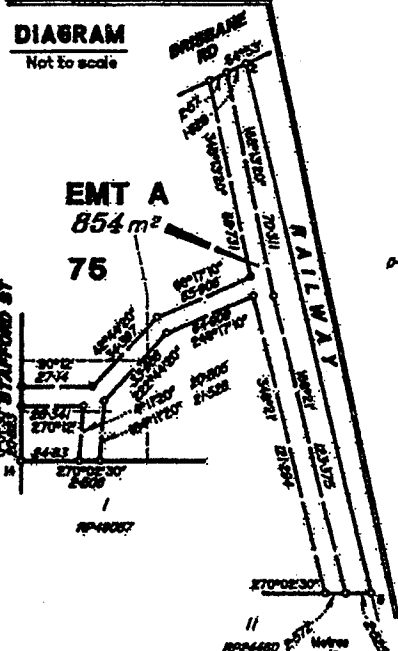

NOTE:
Part of Lot 75 is Restricted to the depth of 21.33m and Part to the depth of 15.24m from the surface only.

I, Mark Alan SURVEYOR, hereby certify that I have surveyed the land comprised in this plan personally, that the plan is correct, that the said survey was performed in accordance with the Survey Act 1977 and the Survey Regulation 1982, and that the said survey was completed on 6/2/98.

Mark Alan Surveyor

Date: 6/2/98

PLAN OF **Lot 75 in Strata and Proposed Easement A**
in Strata in Lot 75 Cancelling Lot 2 on RP24436 (To the Depth of 15.24 m from the surface only), Lots 1 & 2 on RP26307 (To the Depth of 21.33 m from the surface only), Lot 2 on RP24437, Lot 2 on RP24438 (To the Depth of 21.33 m from the surface only), Lot 2 on RP24439 (To the Depth of 21.33 m from the surface only), Lots 1 & 379 on RP44828 (To the Depth of 21.33 m from the surface only) and Lot 2 on RP44828.

PARISH: **IPSWICH** COUNTY: **Stanley**

Mark: RP44828 F/A: YES

Scale: **1:1250**

Format: **STANDARD**

EXAMPLE 10

Plan Status:

NOTE:
1. Demarcation of change in depth to be marked on the surface

Plan Requirements For Actions Affecting Easements

**Area Resumed by The State (Lot 4) in Freehold or State Land
(including Main Road Resumptions)**

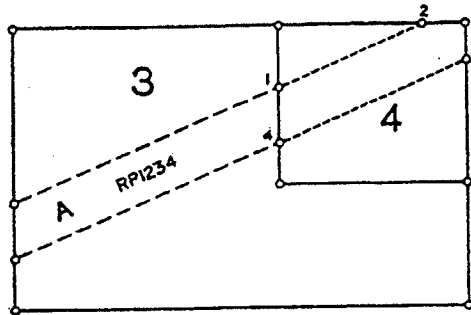

Area to be Excised from
EmtA on RPI234
(1-2-3-4).....0000 m

**Road To Be Opened (including area to be excised) at the
Instance of Local Government in Freehold or State Land**

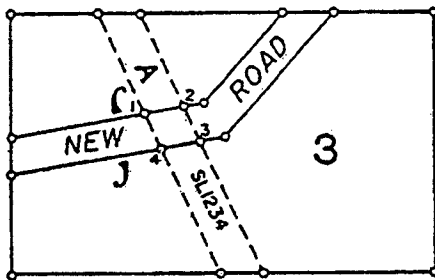

Area of EmtA on plan SL1234
affected (1-2-3-4).....000m

Road To Be Closed (including Area To Be Added)

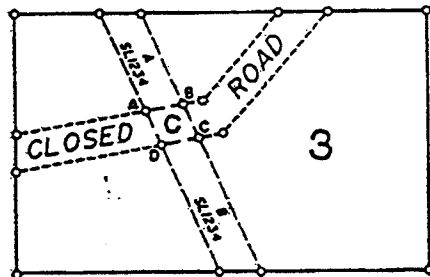

Plan required of Proposed Easement C - (A-B-C-D) to register
easement rights over the closed road

Subdivision (Freehold And State Land)

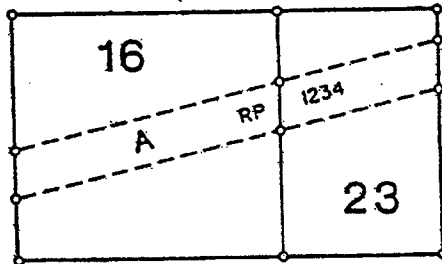

NOTES

1. If the same type of Tenure is to issue over the Lot being sold (Lot 23) no new Easement or Easement action is required.
2. If an absolute surrender of Lot 23 to the State has taken place and a new lease of a different type is to issue thereover, then the new plan of easement is required in both Lots 16 and 23.
3. See also Easements Dept. A requirements E3.

Easements with Height Restrictions

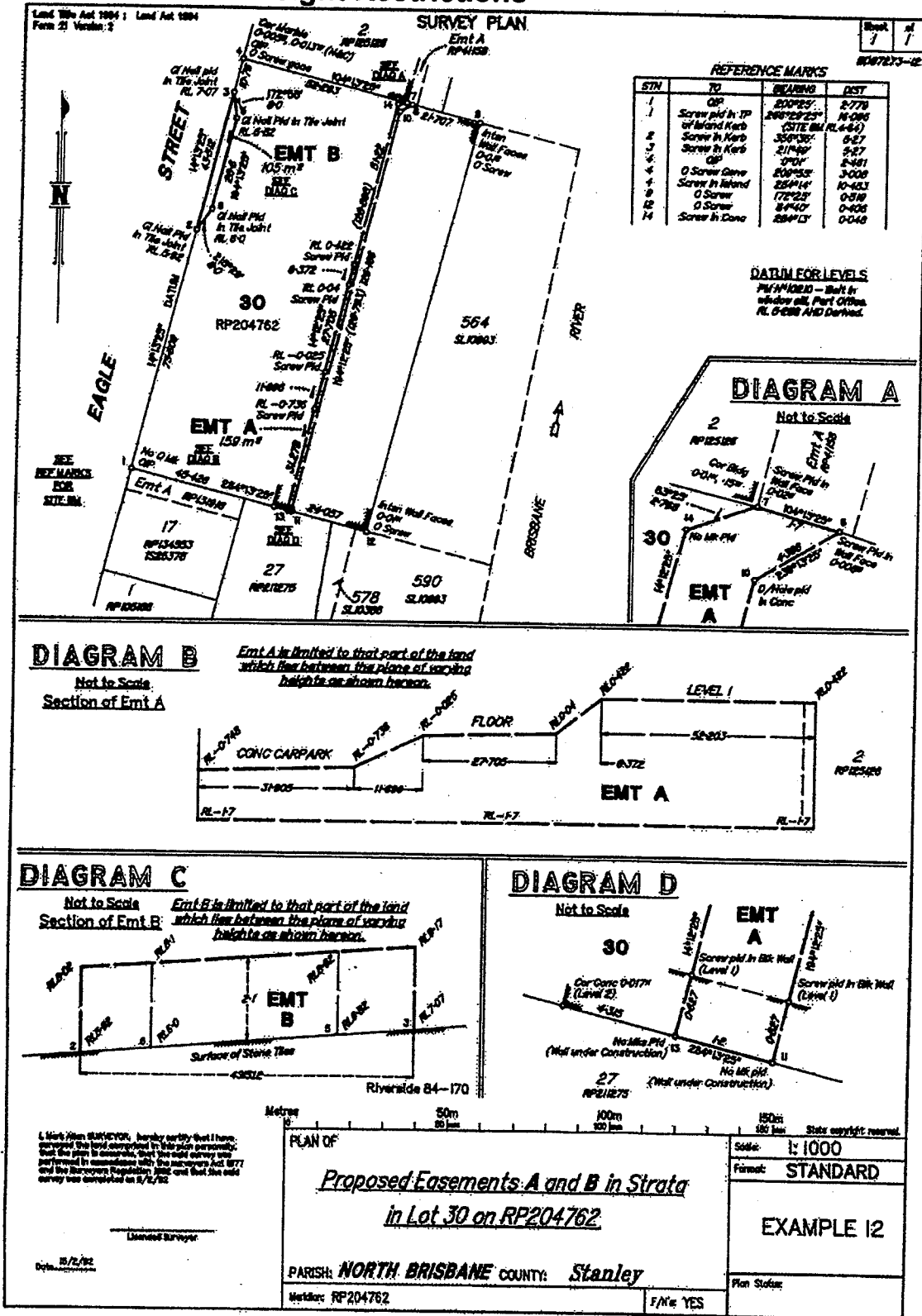

Esplanades (Unsurveyed)

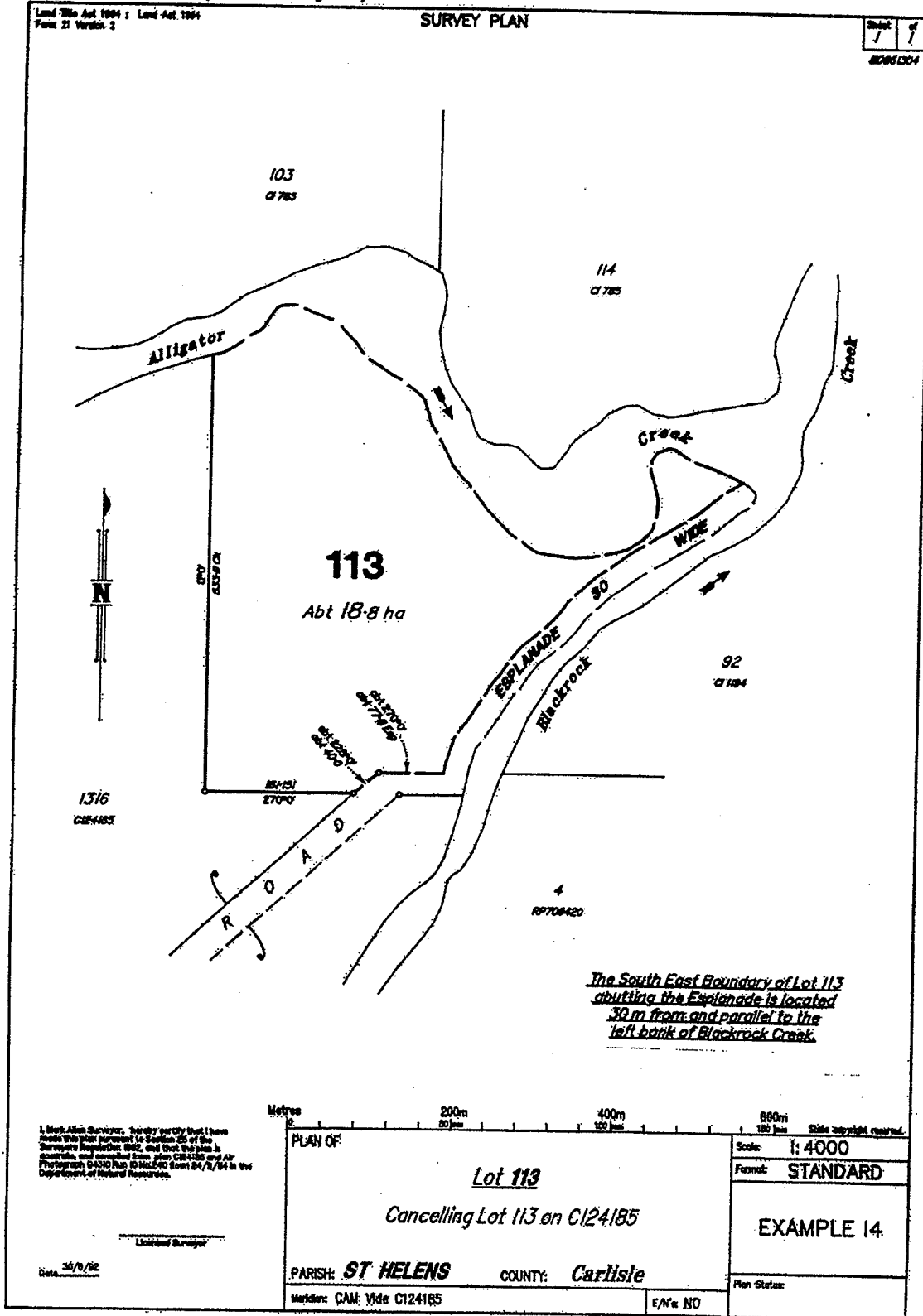

NOTES

1. Statement on face of the plan for location of Esplanade boundary.
2. Refer to Surveyors Regulations and Recommended Practices for Survey Procedures
3. See also notes with Example Plan No 7

Excision (From State Land added to State Land)

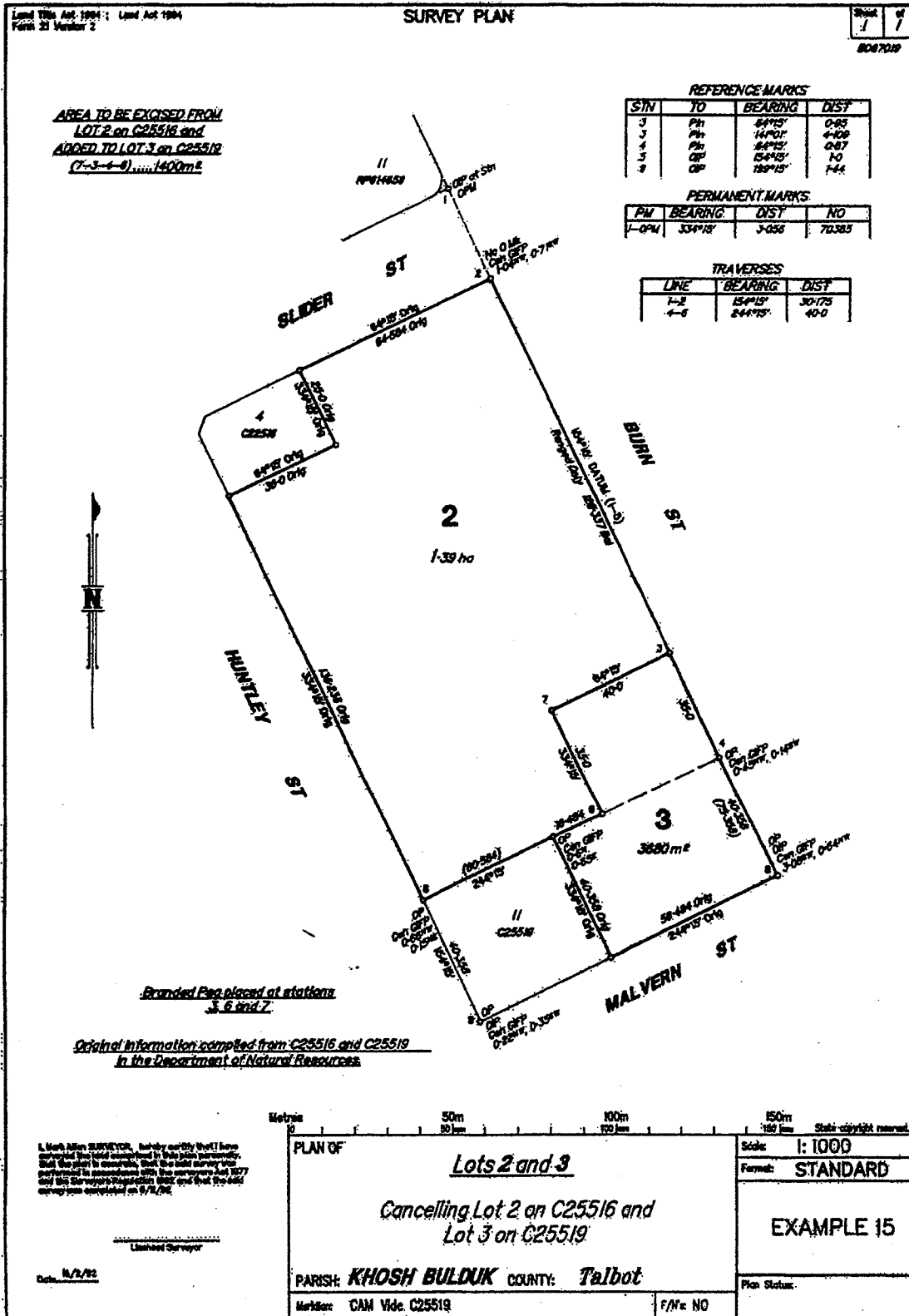

NOTES:

1. Wording of Action Statement and full description of land involved.
2. Parcels retain their previous numerical identifier as the new description for the amended Lots.

Identification Survey

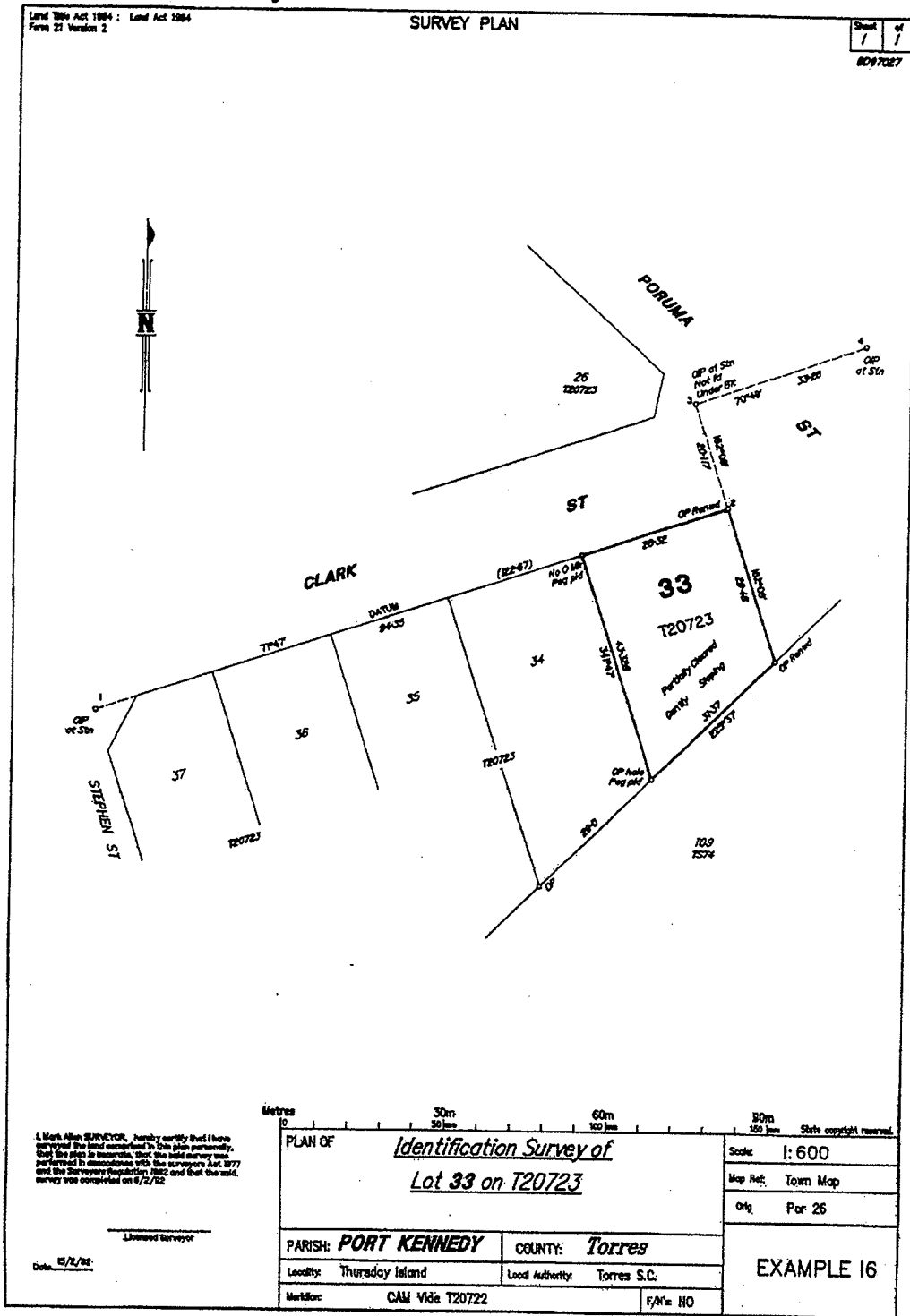

NOTES

1. Full description is shown on the subject Lot and in the Title of the plan in subject style (i.e. Lot on Plan description).
2. The Department encourages the use of standard plan forms for these surveys, however Identification Surveys deposited as sketch plans and survey records will be accepted. Plans must be legible and conform with A3 or A4 size.
3. Identification Surveys will not be registered, nor examined at the time of deposit. However, an option to examine the plan will be reserved by the Department.
4. Identification Surveys should be labeled with a pre-numbered barcode label prior to depositing with Dept A. Identification Survey Plans are recorded in the CISP Database.
5. Map References should be shown on Identification Surveys.

Identification Survey

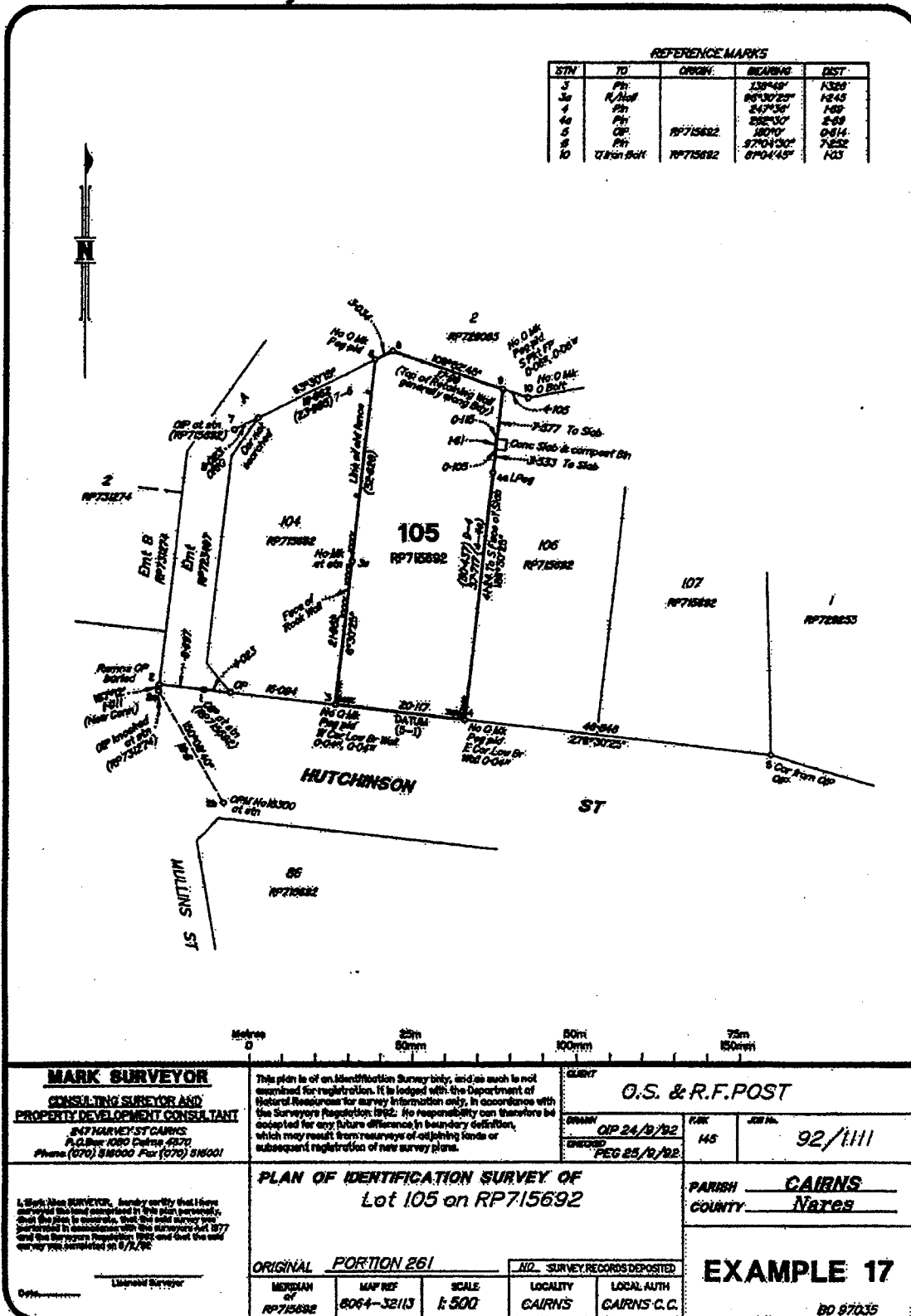

STN	TO	CRDGY.	BEARING	DIST
3	Pin		138°45'	1320
3a	R/Stub		86°30'25"	1245
4	Pin		247°35'	1400
4a	Pin		282°30'	260
5	CP	RP715692	180°0'	0.614
6	Pin		177°04'30"	7.852
10	Urban Bolt	RP715692	07°04'45"	103

<p>MARK SURVEYOR CONSULTING SURVEYOR AND PROPERTY DEVELOPMENT CONSULTANT 247 HARVEY ST CAIRNS P.O. Box 1100 Cairns Q170 Phone (077) 316000 Fax (077) 316001</p>	<p>This plan is of an Identification Survey only, and as such is not submitted for registration. It is lodged with the Department of Natural Resources for survey information only. In accordance with the Surveyors Regulation 1992, no responsibility can therefore be accepted for any future difference in boundary definition, which may result from resurveying of adjoining lands or subsequent registration of new survey plans.</p>	<p>CLIENT O.S. & R.F. POST</p>	
		<p>DATE QIP 24/9/92</p>	<p>FIC 145</p>
<p>I, Mark Alan SURVEYOR, hereby certify that I have surveyed the land comprised in this plan pursuant to, and in accordance with, the provisions of the Surveyors Act 1977 and the Surveyors Regulation 1992 and that the said survey was completed on 8/7/92.</p> <p>_____ Licensed Surveyor</p>	<p>PLAN OF IDENTIFICATION SURVEY OF Lot 105 on RP715692</p>		<p>PARISH <u>CAIRNS</u> COUNTY <u>Nares</u></p>
	<p>ORIGINAL <u>PORTION 261</u></p>	<p>NO. SURVEY RECORDS DEPOSITED</p>	<p>EXAMPLE 17 BD 87035</p>
<p>MERIDIAN of RP715692</p>	<p>MAP REF 8064-32113</p>	<p>SCALE 1:500</p>	<p>LOCALITY CAIRNS LOCAL AUTH CAIRNS C.C.</p>

Group Title Plan

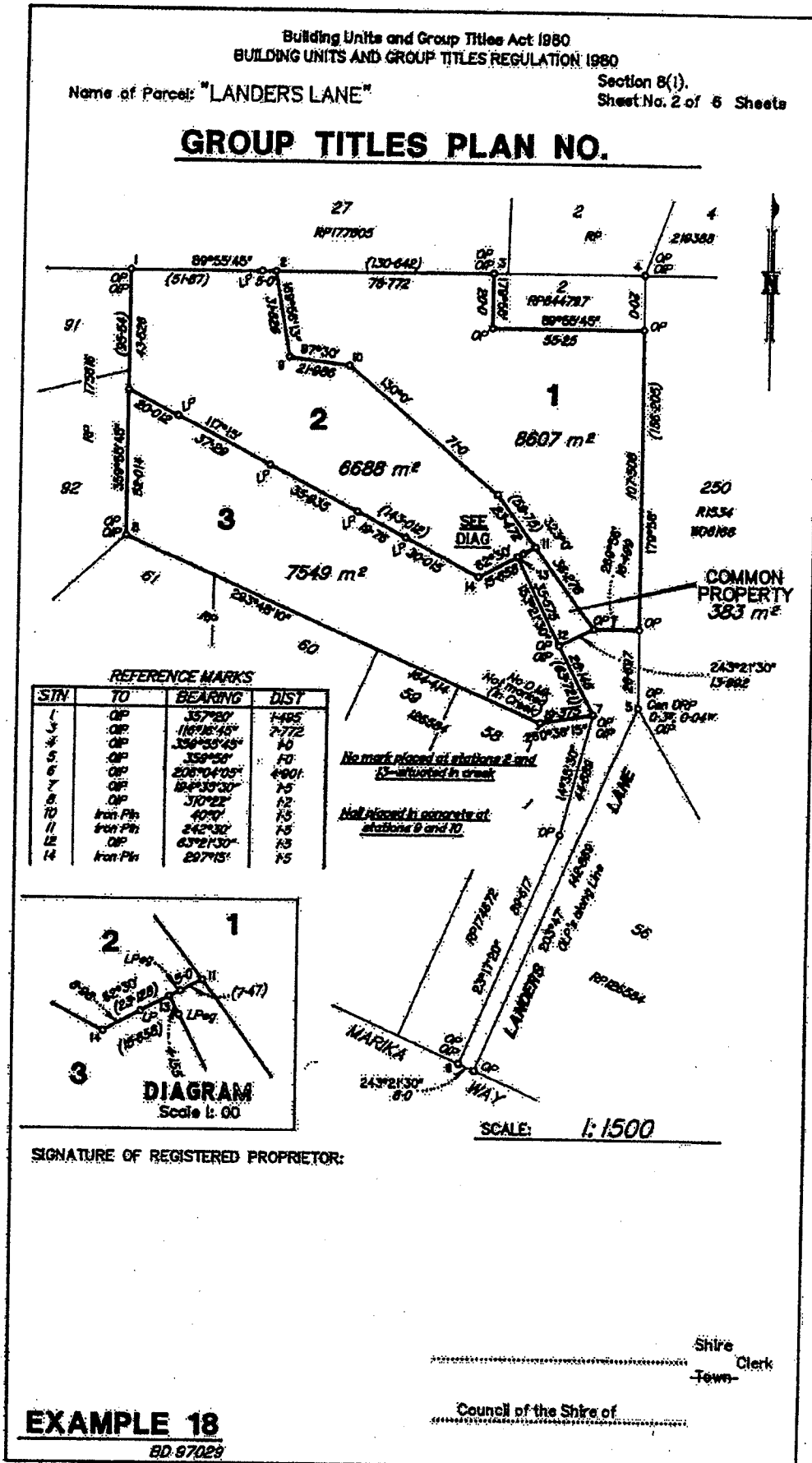

Group Title Plan

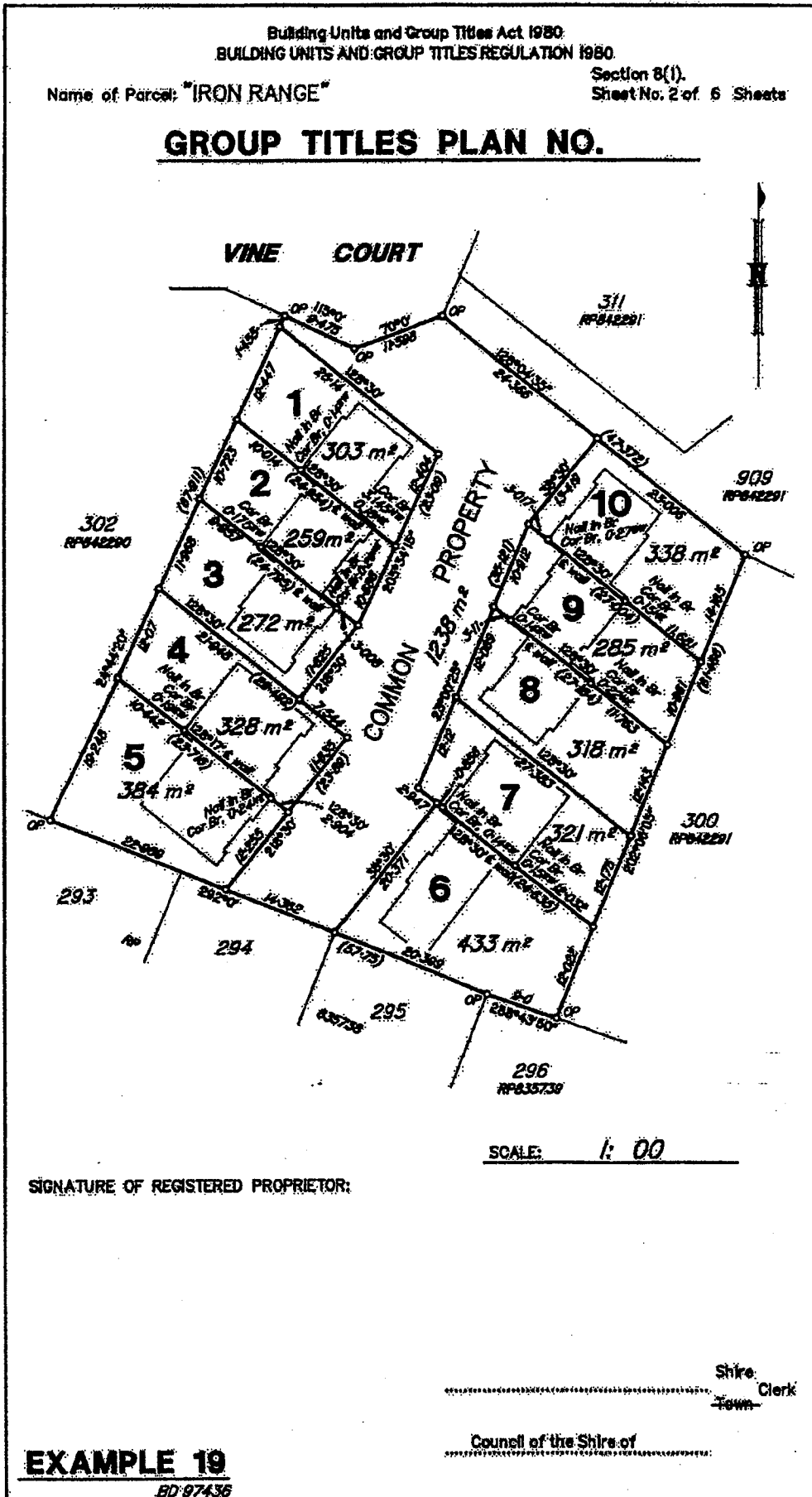

Lease on Registered Plan Form (In freehold Land)

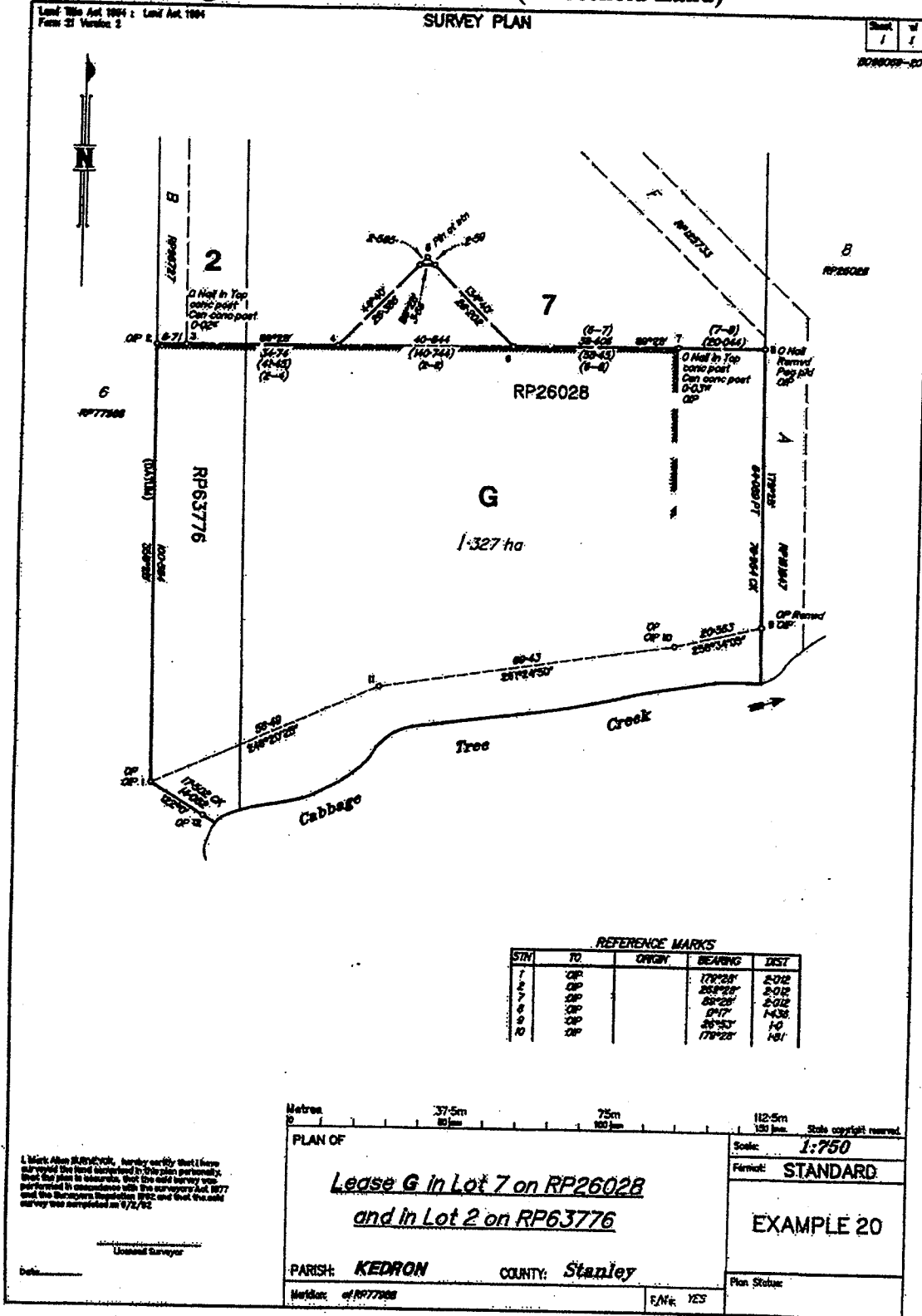

Leases (In State Reserves e.g. State Forest)

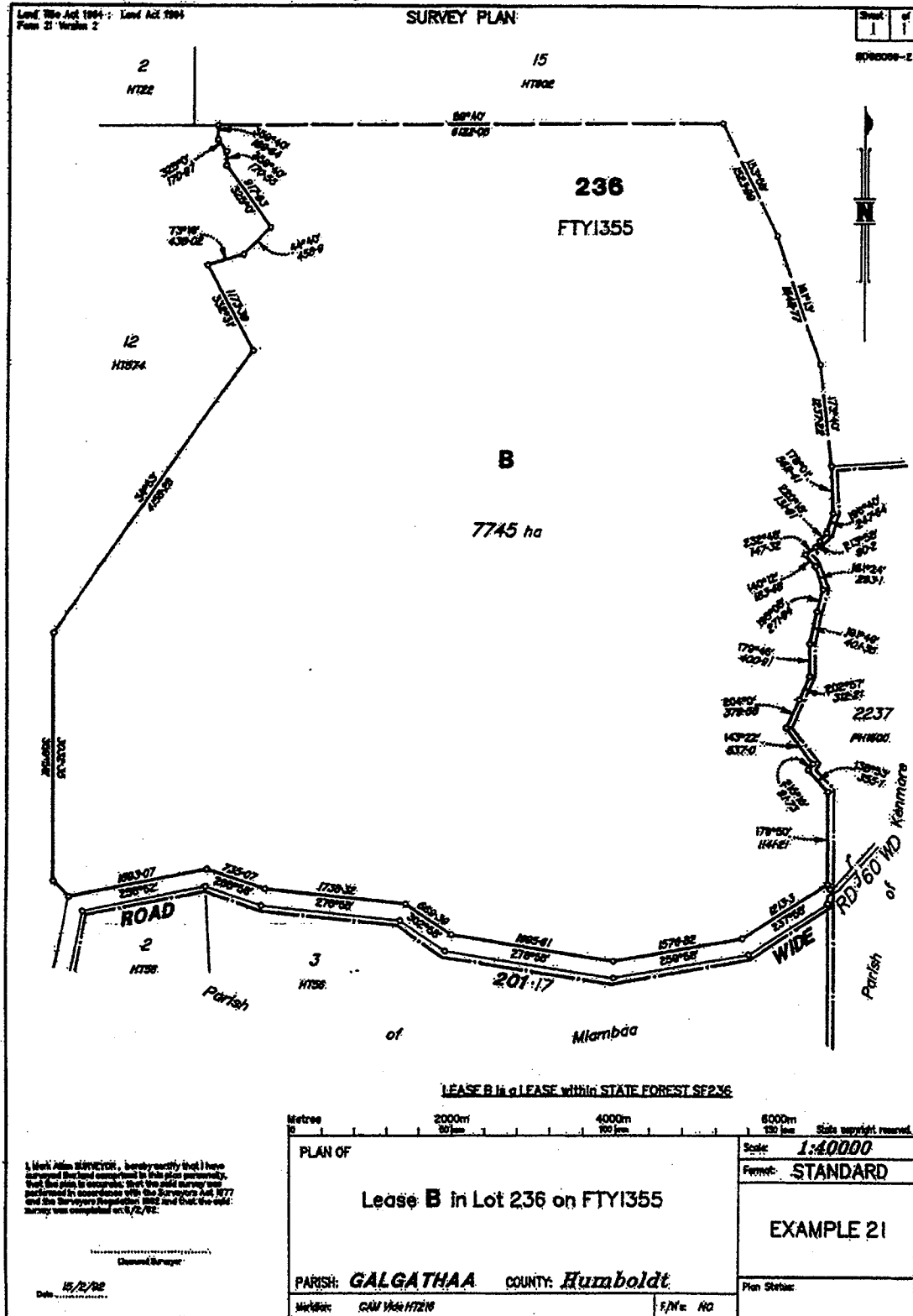

NOTES:

1. Lease B is a Term Lease within a State Forest described as Lot 236 on FTY1355, issued under Section 32. Of the Land Act 1994 and Section 35(2) of the Forestry Act
2. The wording in the Title Block and the full description shown on the face of the plan in subject style.
3. Boundaries are shown broken in subject style (similar to Easements) except where they are co-incident with surveyed Cadastral boundaries.
4. Alpha descriptions must not be repeated in any one parcel

Lease (In vested areas e.g. Harbour Boards)

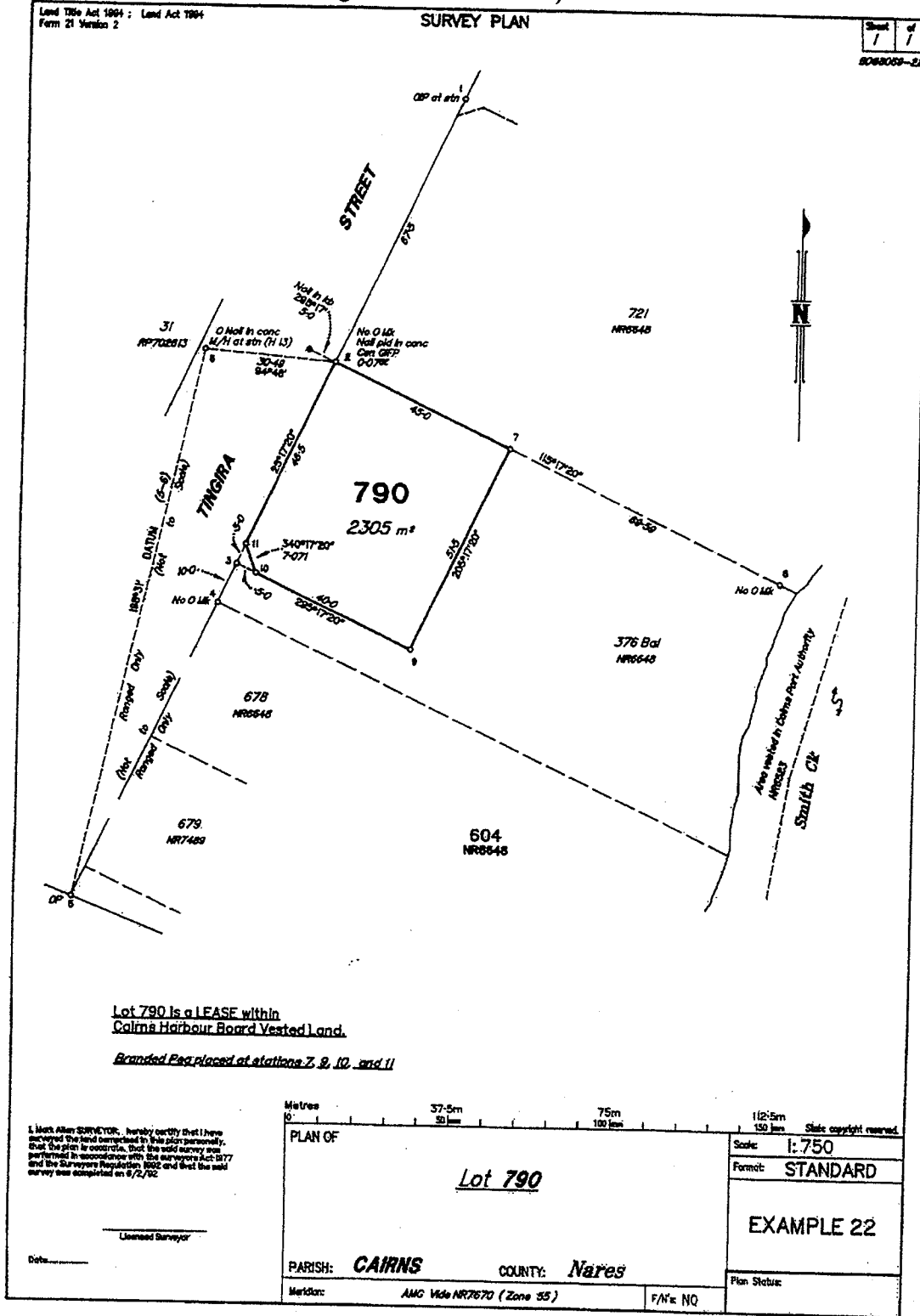

NOTES:

1. Plans for Leases in Harbours Corporation are to be submitted to the Department of Transport for approval prior to lodgement.
2. The statement describing Lot 790 that is shown on the face of the plan.
3. Description of Vested Area (Lot 604 on NR6648) within which the Lease is located, is also shown in subject style.
4. Any additional requirements should be obtained from the relevant Harbours Board/Port Authority concerned.

Photogrammetric Survey

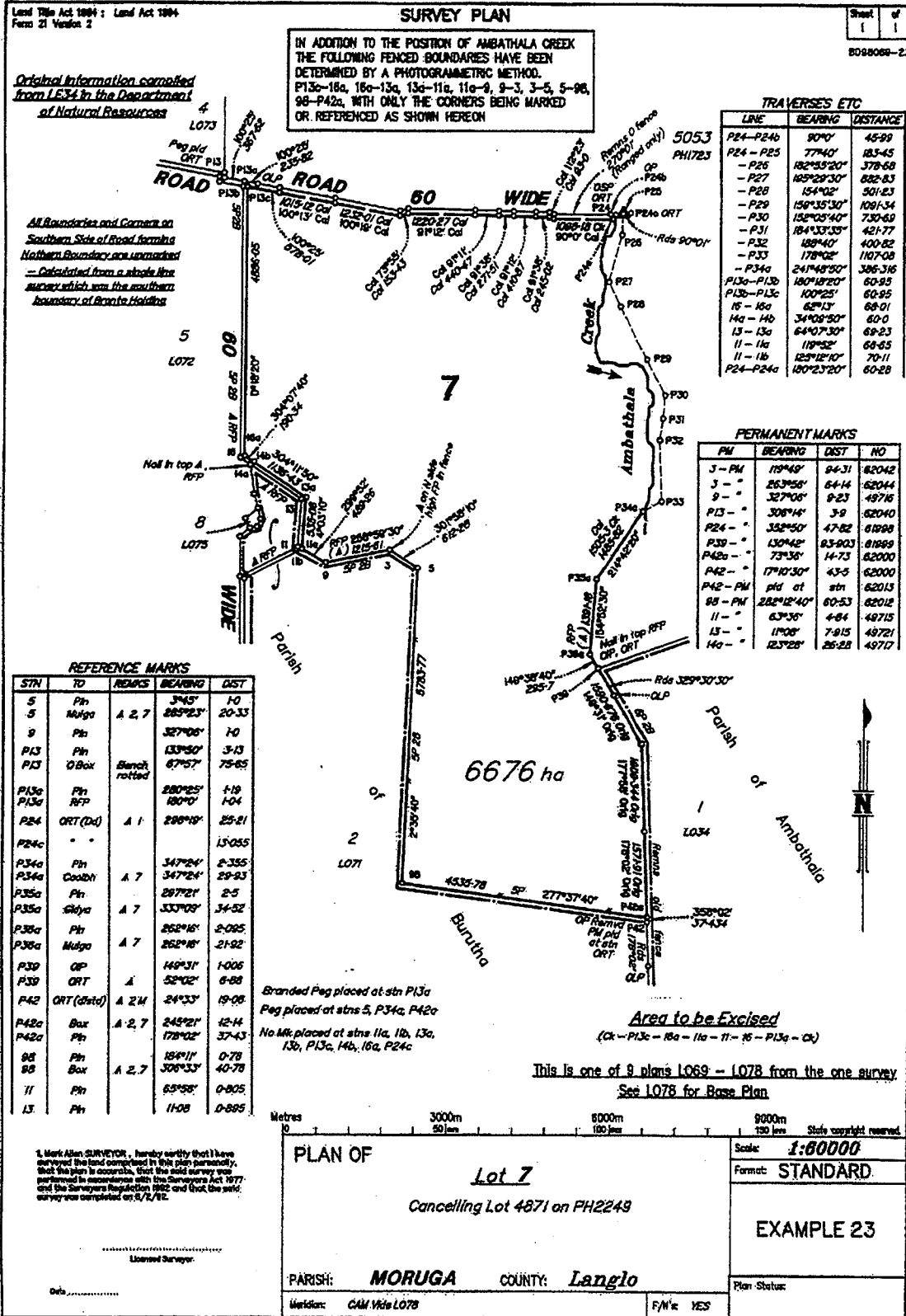

- NOTES:**
- For advice on this method of survey contact the Dept A District Surveyor.
 - Features (Fences, Creeks etc.) identifiable on the photography are to be adopted as boundaries.
 - Boundaries determined by a photogrammetric method must be stated and identified on face.
 - Statements on face of plan

Railway in State Land

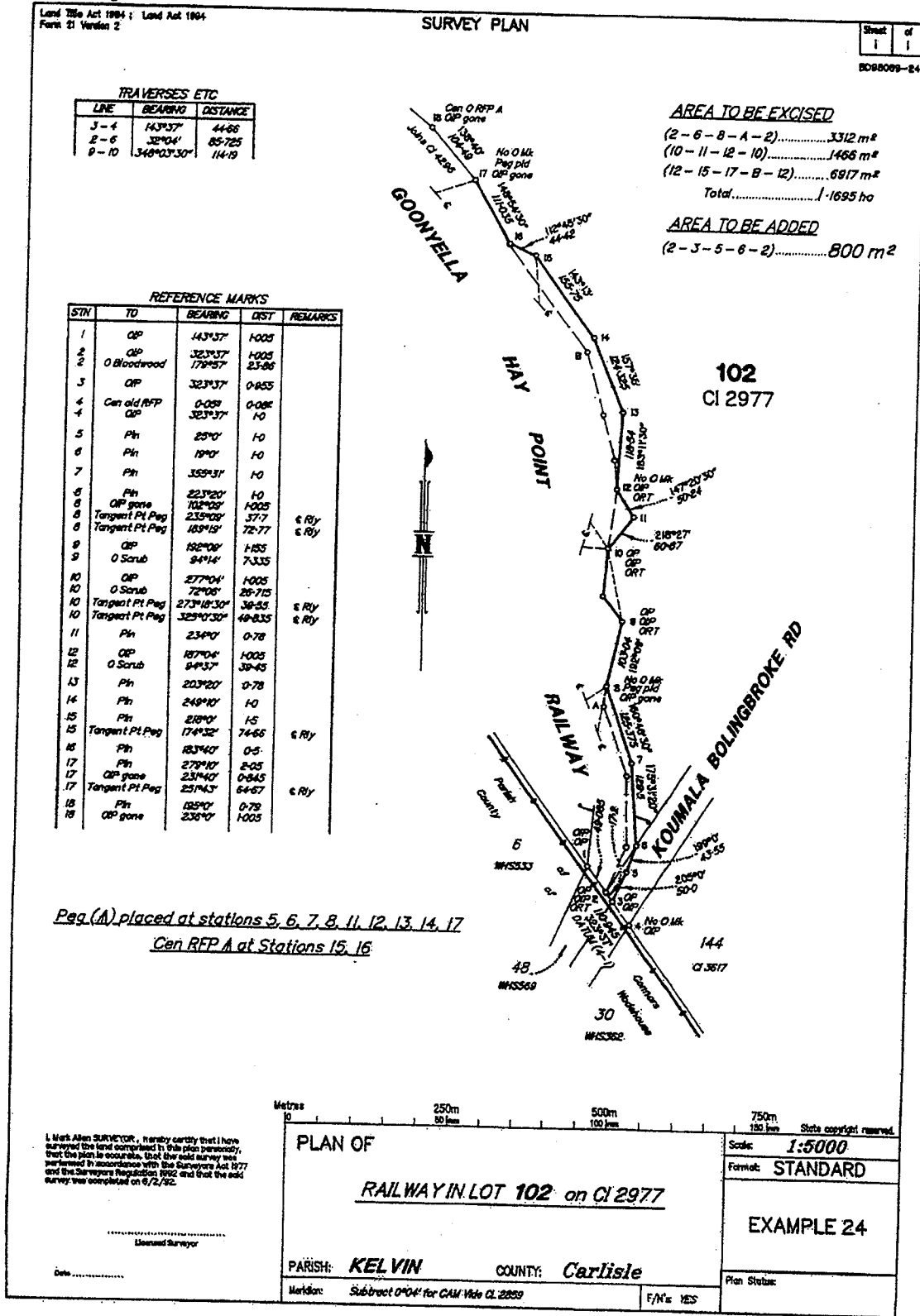

- NOTES:**
1. Wording of Action Statements
 2. In this particular case, a Section 25 Compiled Plan is required for the balance of Lot 102.
 3. If Railway area is already resumed prior to survey, Action Statement will be titled "AREA EXCISED".
 4. For Railway in Freehold Tenure, a subdivisional survey plan is prepared.

Resurvey

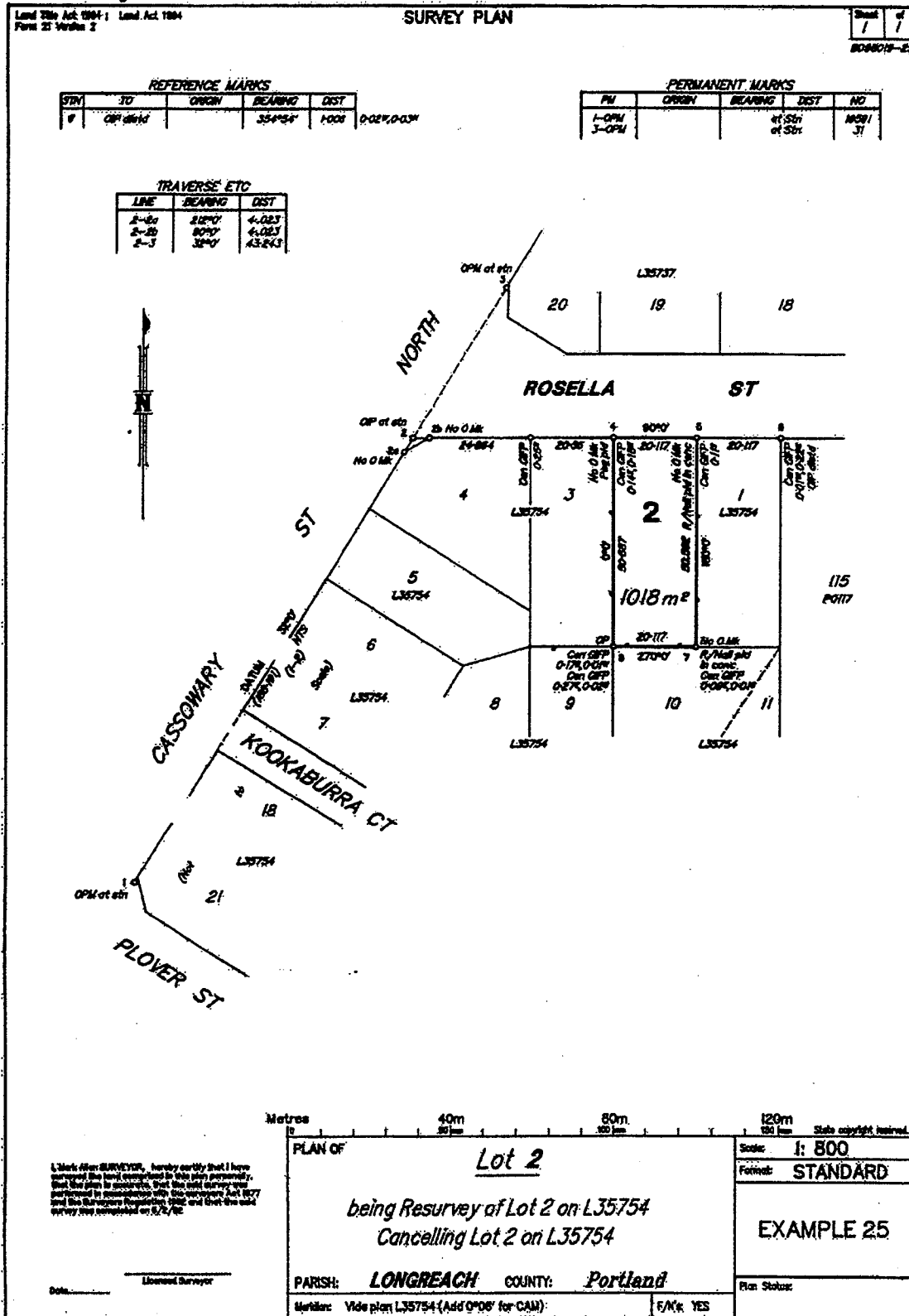

NOTES:

1. Prepare and lodge plan as a normal survey.
2. Show Area on subject Lot.
3. Wording of Plan Title.
4. This plan can be used for future land transactions.
5. Parcel retains its previous numerical identifier as the new description of the amended Lot.

**Road Closure (Addition to and Amalgamation of Freehold Tenure)
(Vide Section 358 and 98 of the Land Act 1994)**

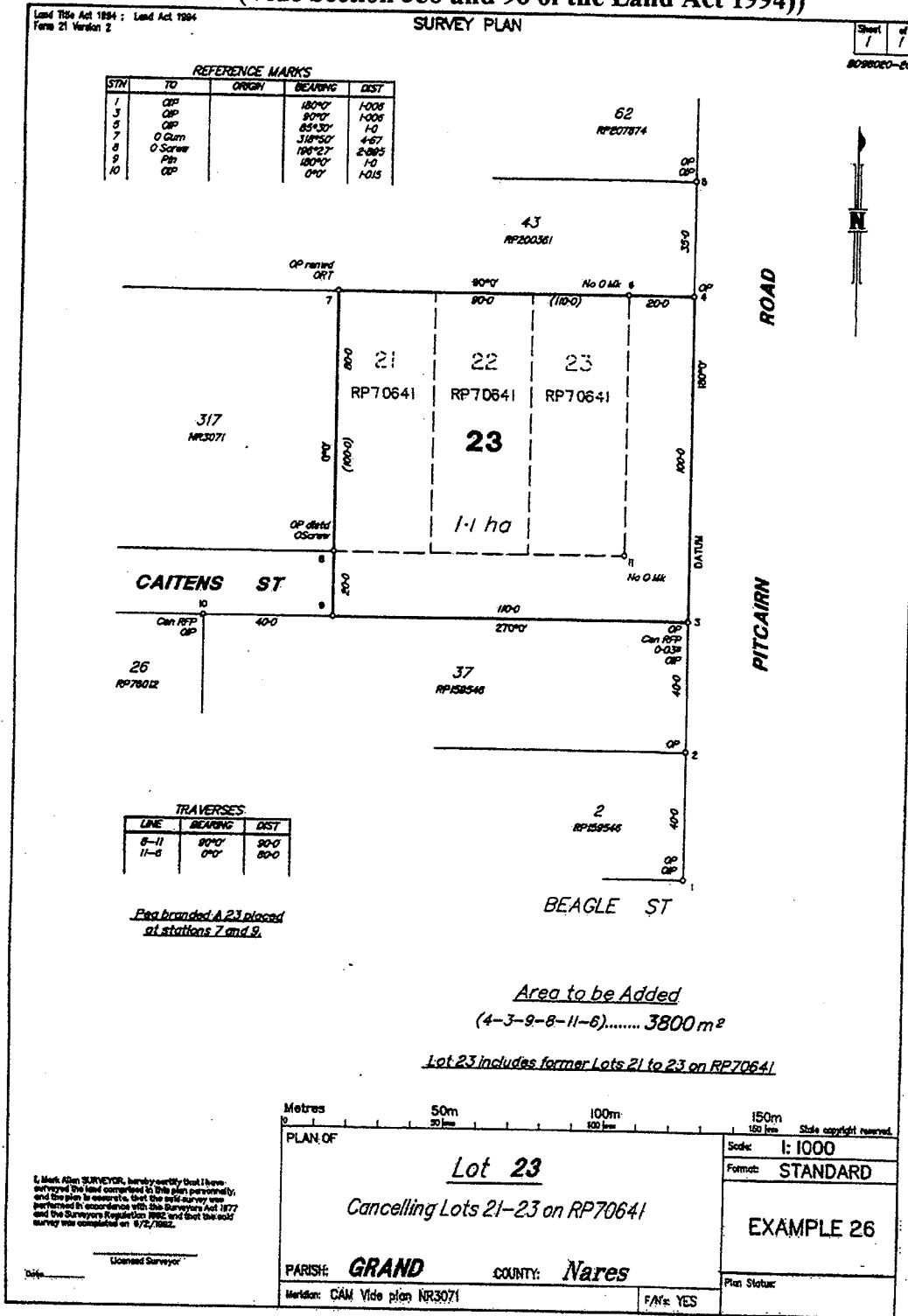

NOTES:

1. Lots 21, 22 and 23 on RP70641 are individual parcels held as a Consolidated Title to which it is proposed to add an area of "ROAD TO BE CLOSED" (4-3-9-8-11-6). Dept A approval has stipulated amalgamation into one Lot due to removal of access. The Land Act 1994 Section 358 and 98 permits these Actions to be effected on one plan.
2. The Action statements on the face of the plan required for this action.
3. The description of the new Title will adopt one of the previous numerical identifiers.
4. The description of the lapsed parcels may be shown in dotted style where space permits.

Road Closure (Addition to undescribed Railway)

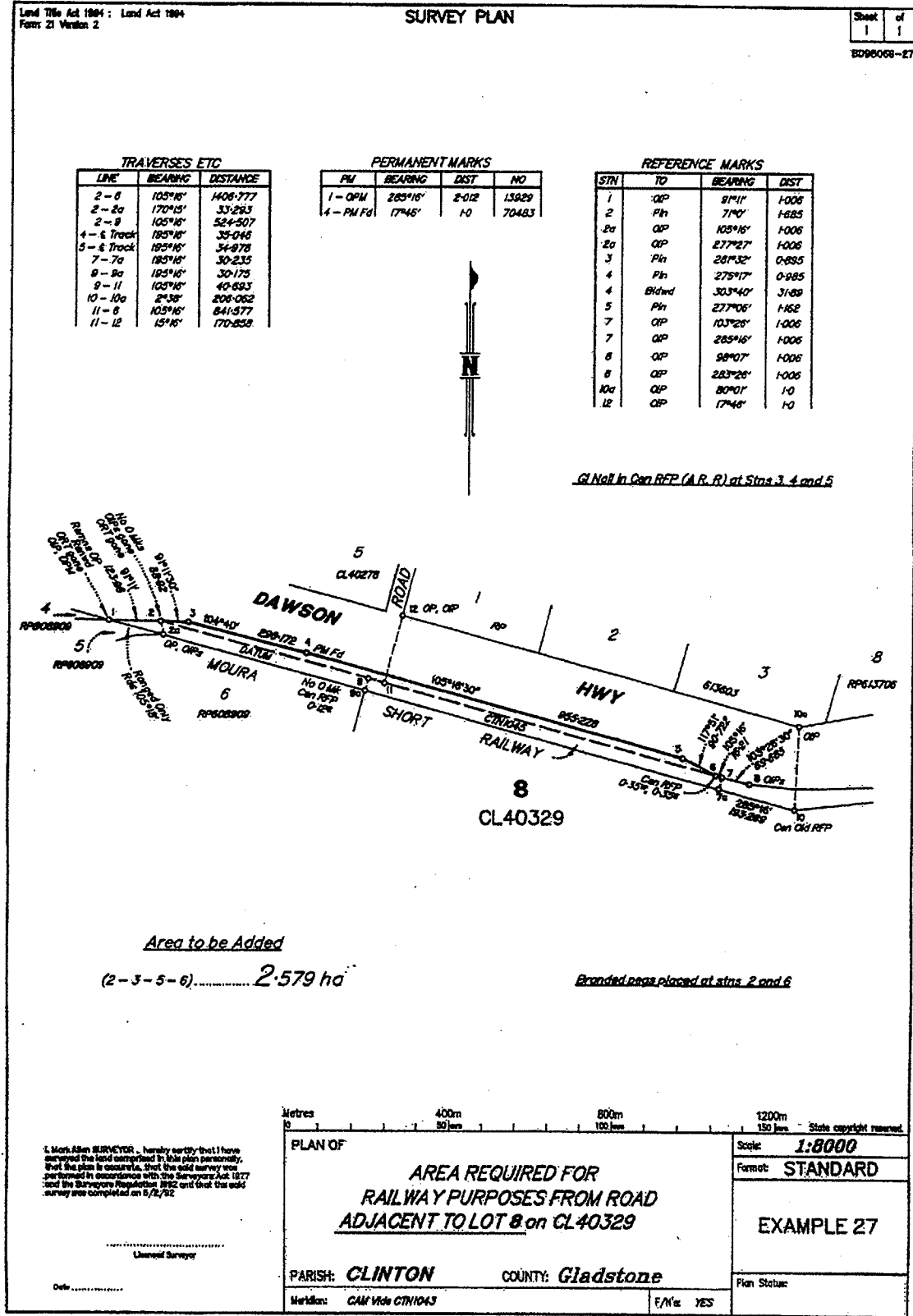

NOTES:

1. As Railway has no Property Description, an adjoining "Lot on Plan" description must appear on the plan and in the Title block in the subject style to aid location and enable the survey to be recorded in the Dept A CISP database.
2. A plan of the amended Railway Area is not required for this type of case.

Road Closure (For complicated cases) Involving criss-crossing of old and new roads

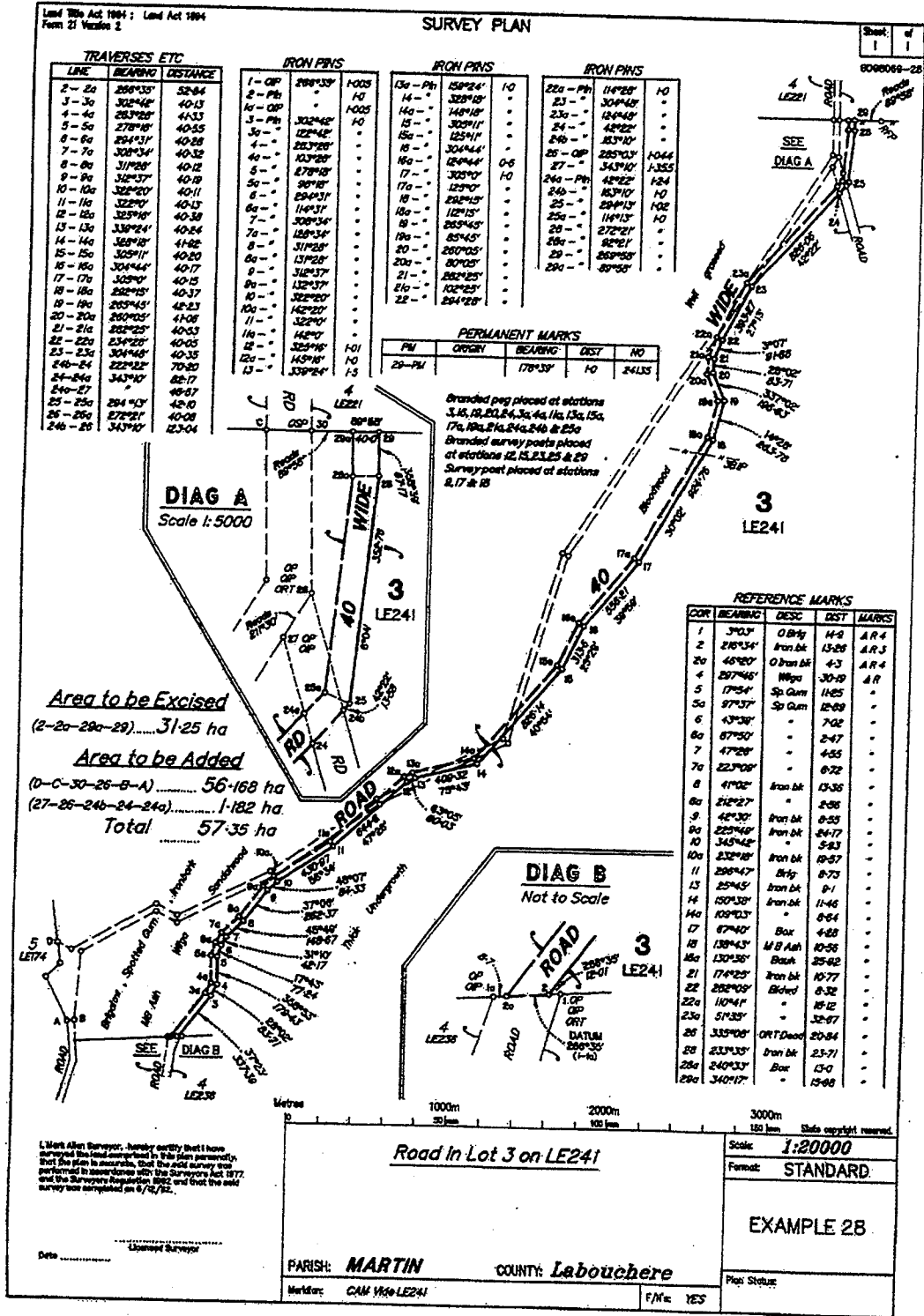

NOTES:

1. New and Old Road to be included in the Action Statement on face of plan.
2. Survey and calculations of internal road intersections and severances are not necessary unless stipulated in the Dept A approvals.
3. In State Land the Lessee is required to "Surrender" lands from their Lease to enable road actions to proceed, these lands will need to be identified on the face of the plan. Action Statement i.e. "Area to be Surrendered" with qualifying station numbers will need to be shown. Areas should be calculated.
4. Section 25 compiled plan to be prepared as necessary for the amended Lot. (Amended Lot can be completed on the plan of survey if scale permits).

Road Opening (MRD Resumption where noticable erosion in watercourse boundaries is noted)

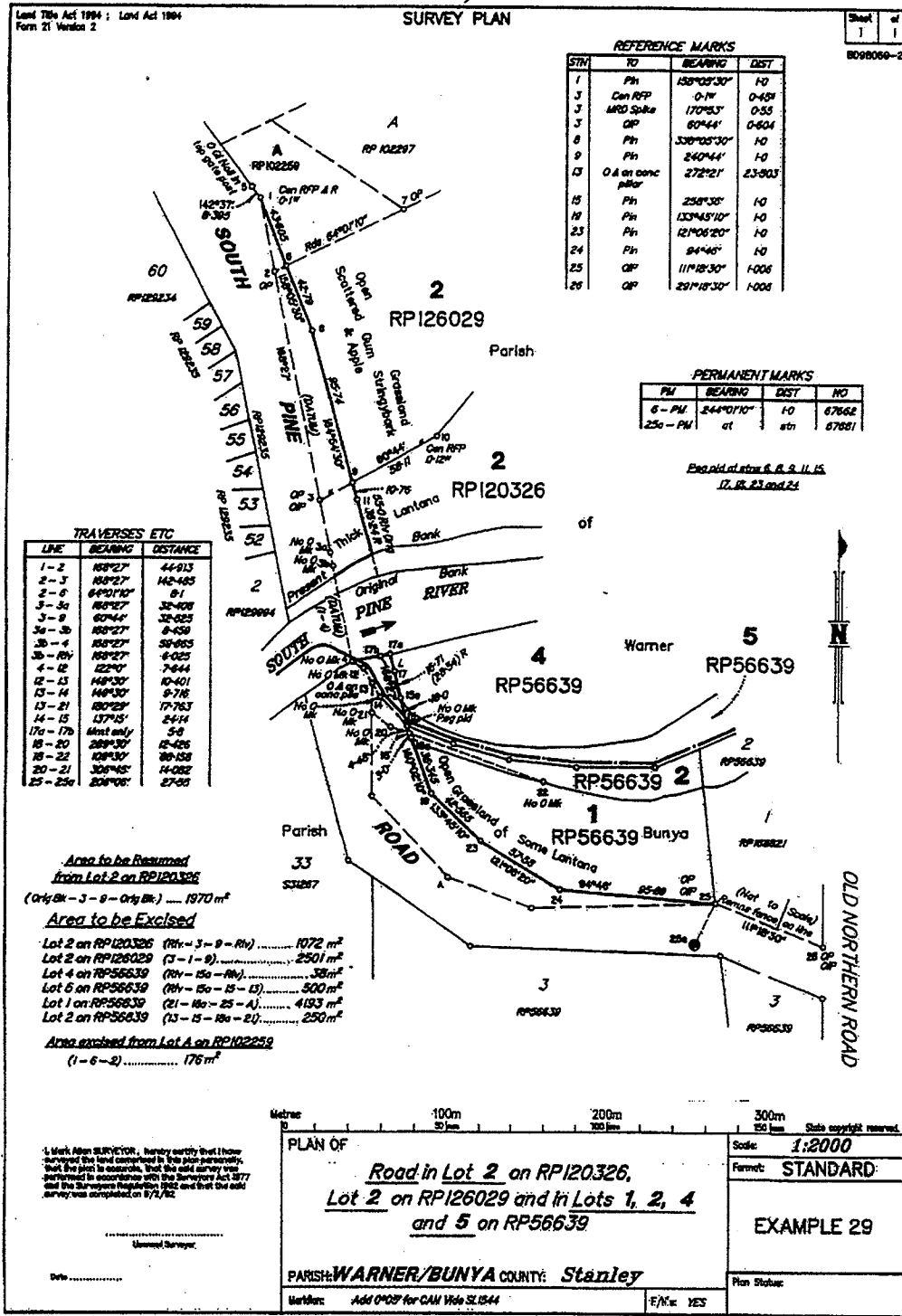

NOTES:

1. The special Action Statement necessary in this case.
2. The method of depicting data on face of plan for location of "present" and "original" river banks.
3. An area for the New Road in the affected parcel (Lot 2 on RP120326) need not be shown.
4. Cases for accretion are treated in a similar manner. See Example Plan No 30.
5. In addition to the local street and road names, the declared Main Road Name should be shown e.g. BRUCE HIGHWAY, TEWANTIN NOOSA ROAD, etc.
6. Plans of the balances of the affected Lots can be prepared provided prior knowledge is available from Main Roads as to whether Section 25 compiled plans are required.
7. Resumption in Freehold land treated as a normal plan of subdivision.
8. See also Ambulatory Boundaries Dept A Requirements E3.

Road Opening (MRD Resumption where noticable accretion in watercourse boundaries is noted)

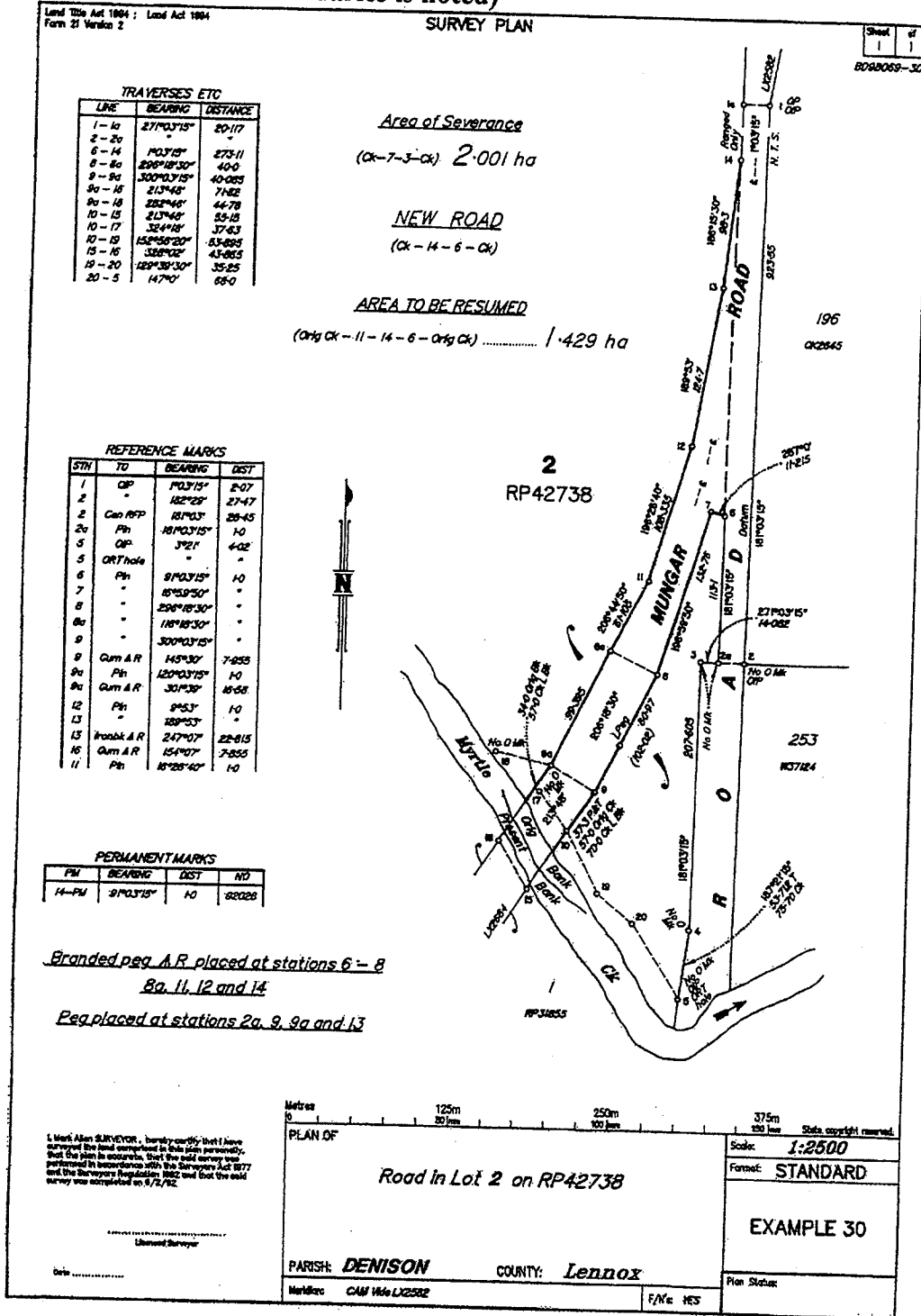

NOTES:

1. The special Action Statement necessary in this case.
2. The method of depicting data on face of plan for location of "present" and "original" river banks.
3. An area for the New Road in the affected parcel (Lot 2 on RP42738) need not be shown.
4. Cases for erosion are treated in a similar manner. See Example Plan No 29.
5. In addition to the local street and road names, the declared Main Road Name should be shown e.g. BRUCE HIGHWAY, TEWANTIN NOOSA ROAD, etc.
6. Plans of the balances of the affected Lots can be prepared provided prior knowledge is available from Main Roads as to whether Section 25 compiled plans are required.
7. Resumption in Freehold land treated as a normal plan of subdivision.
8. See also Ambulatory Boundaries Dept A Requirements E3.

Road Opening (Main Roads Resumption in State Land)

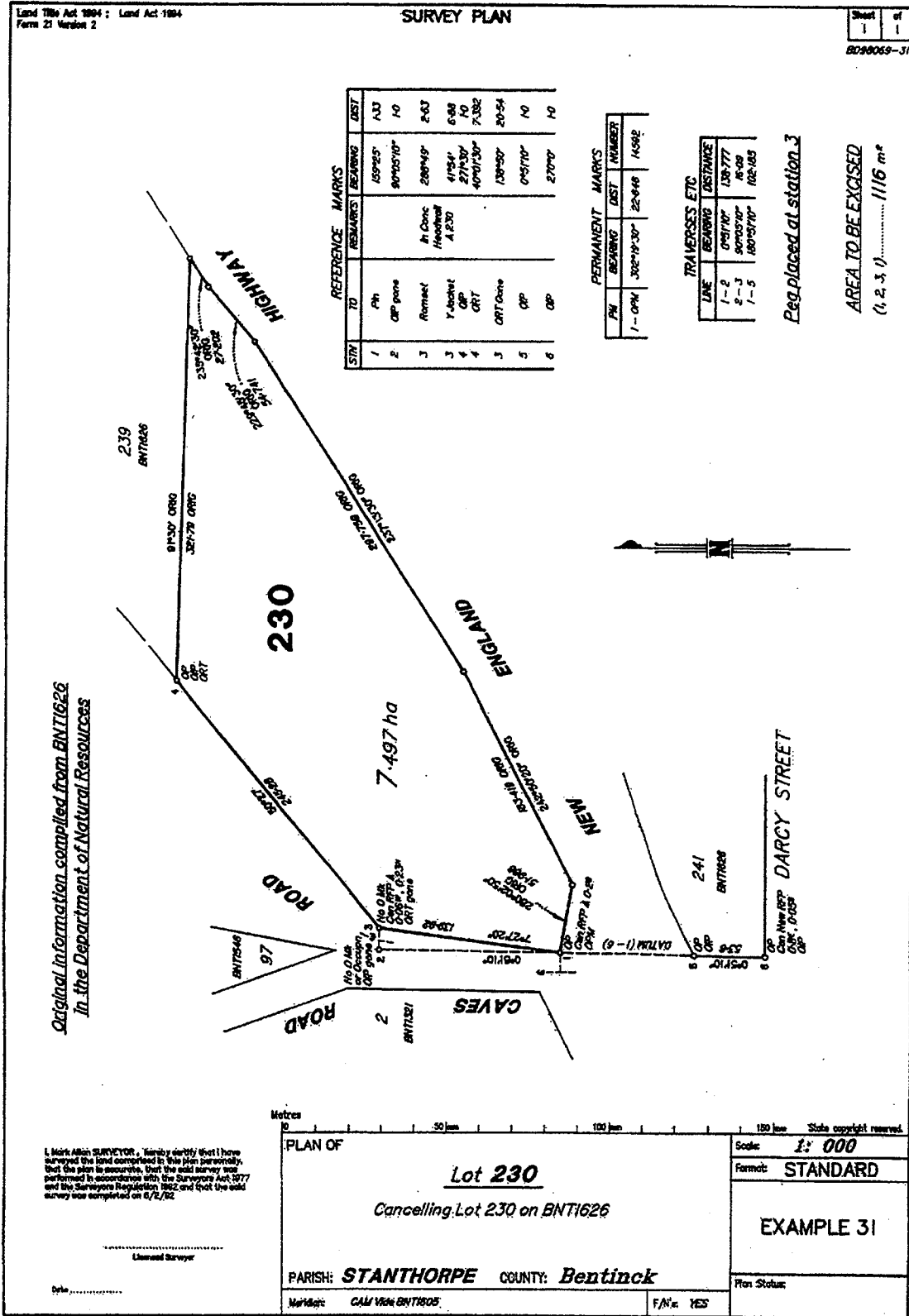

NOTES:

- Where the scale of the plan will accommodate both the Survey Action and the Balance of the State Land, it is advantageous to combine both Actions on the one plan – provided clarity of the plan can be retained upon reproduction at a reduced scale.
- The Parcel retains its previous numerical identifier as the new description for the amended Lot.

Road Opening (Main Roads requirements in Undescribed Railway)

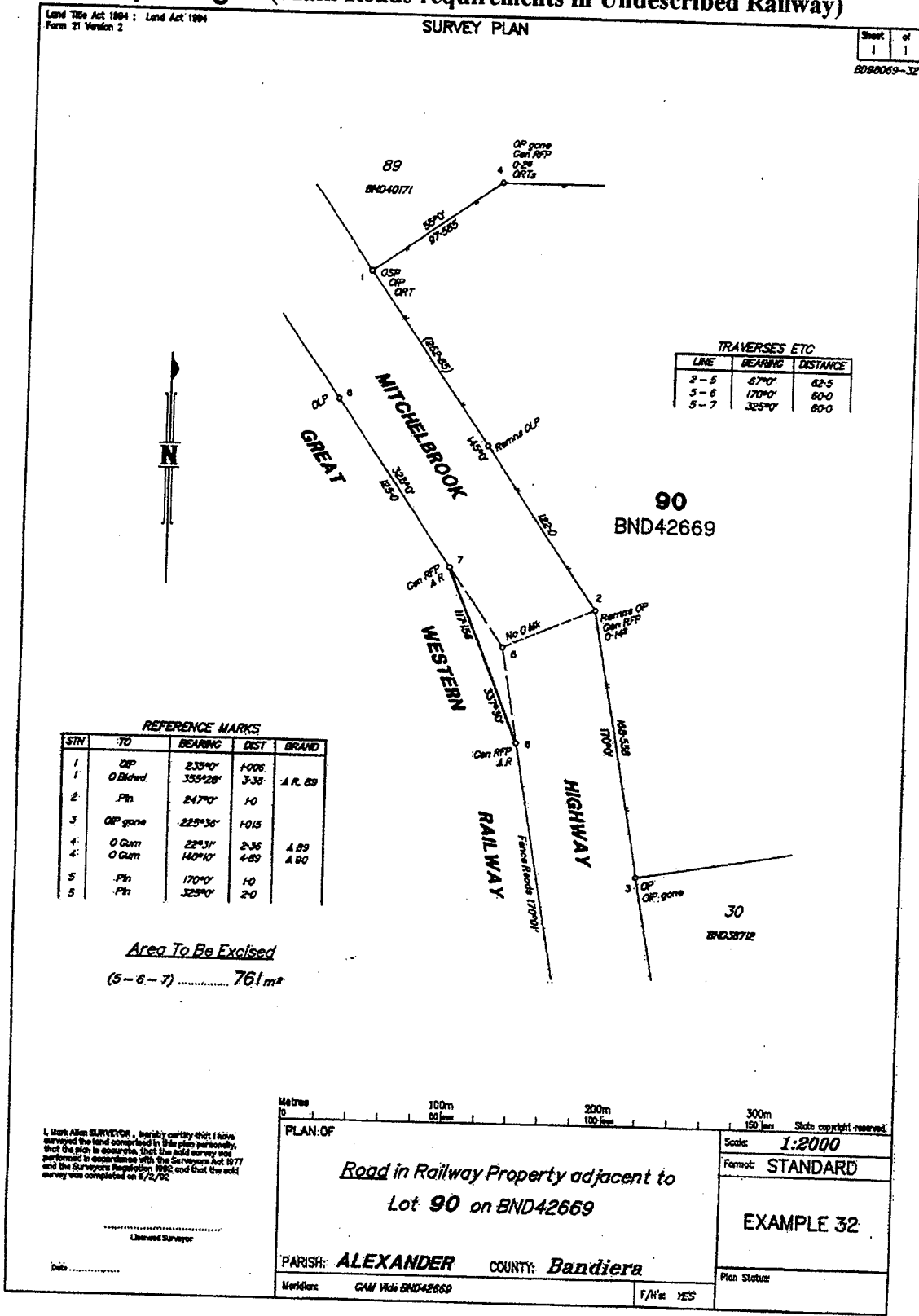

NOTES:

- Title of plan includes reference to an adjoining "Lot on Plan" description to aid location and enable the survey to be recorded in the Dpt A CISP database.
- A plan of the amended Railway area is not required in this instance.

Section 5.8.3 Agreements

(Local Government (Planning and Environment) Act)

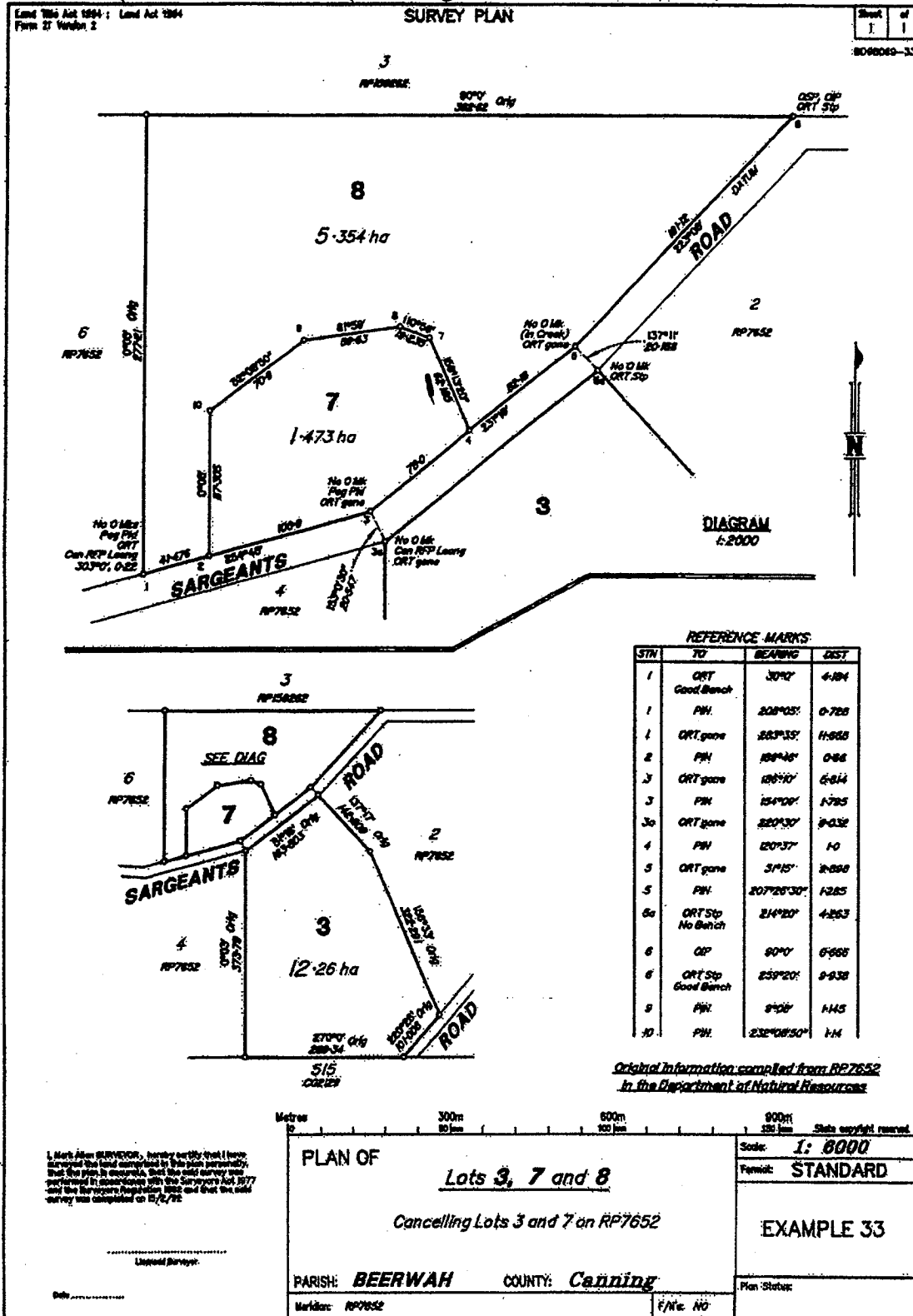

- NOTES:**
- Plan fulfills requirements of Section 5.8.3 of the Local Government (Planning and Environment) Act 1990. (Lots 3 & 7 are linked)
 - Both (or all) Lots which are subject of the proposed or existing agreement are to be shown on the one plan from a common meridian and with connectors (surveyed or original) between the Lots.

Sketch of Lease of Part of Lot

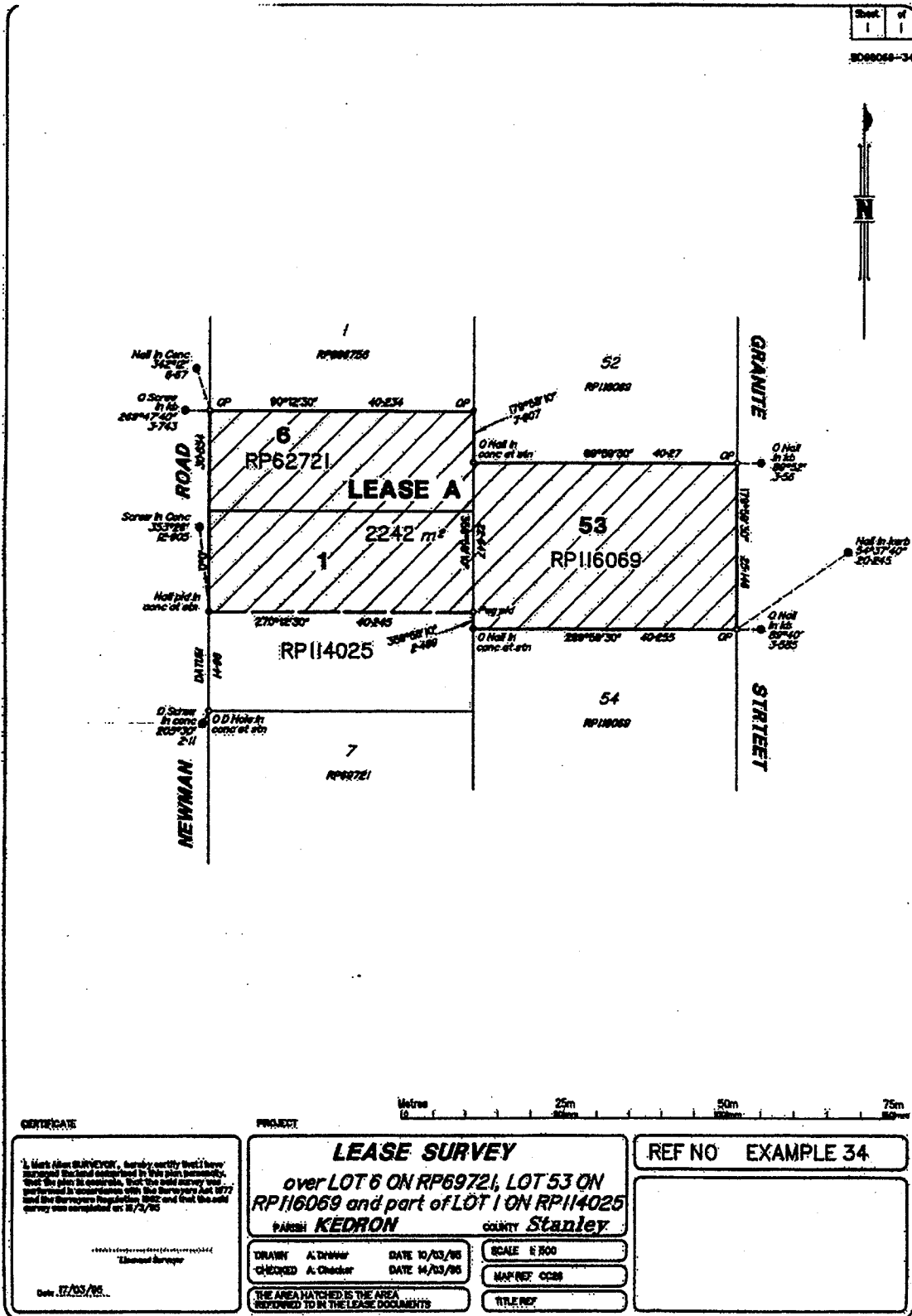

NOTES:

- Two cadastral connections to the Lot boundaries should be made for Leases located within the Lot and not abutting Lot boundaries.

Sub-Lease in State Land (At the instance of the Lessee e.g. Holiday Units)

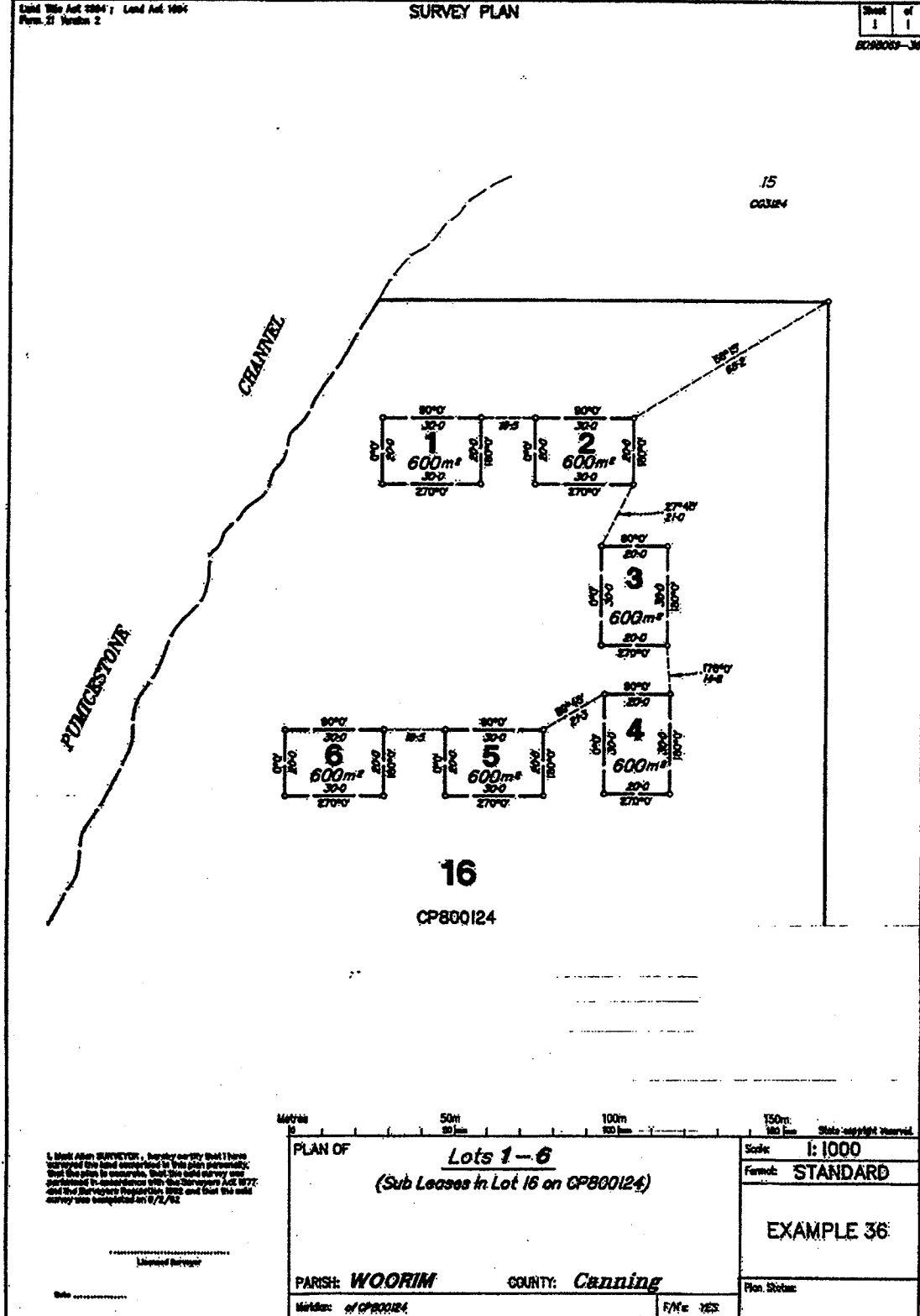

NOTES:

1. A further breakdown of the Sub-Lease need only refer back one generation e.g. a subdivision of Lot 2 above – New plan title would read Lots 3 & 4 (Sub-Leases in Lot 2 on EP800000) and not Lots 3 & 4 (Sub-Leases in Lot 2 on EP800000 in Lot 6 on CP800124).
2. The original parent description, i.e. Lot 16 on CP800124 must be shown on the face of all succeeding plans.
3. Two connections to Lot boundaries should be made for leases not abutting the Lot boundaries.

Tenure in Strata

LINE	BEARING	DIST.
2-3	088° 20' 40"	0.3
3-4	158° 2' 40"	0.307
13-14	323° 0' 40"	0.3
23-24	107° 20'	0.4
24-25	.	.
25-26	236° 13' 30"	.
26-27	.	.
27-28	.	.
28-29	.	.
29-30	.	.
30-31	.	.
31-32	.	.
32-33	.	.

B.M.
R.M. N° 94153 RL 15.733 A.H.G. (Dist.)

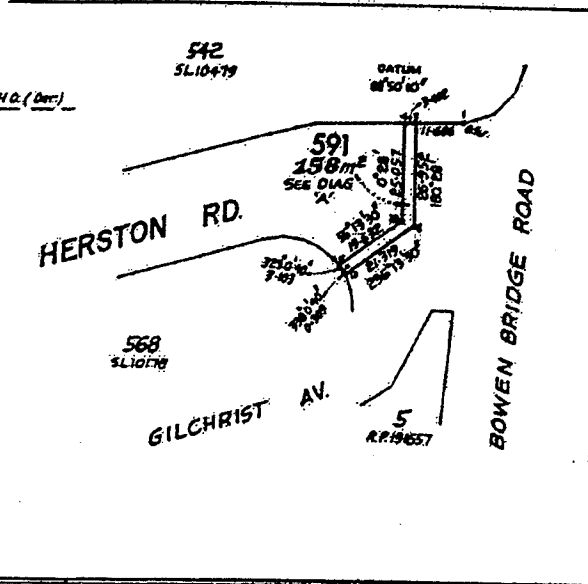

0. Screw at 50m E.S. 35435
No. 400m at 50m 6, 7, 9-12, 16-19, 21 & 22
Drill Hole in Concrete at 50m 3, 4, 20 & 23-34
Drill Hole in Brick at 50m 14 & 15

REFERENCE MARKS

STN	TO	BEARING	DIST.
6	0. Screw	42° 53'	0.453
7	.	167° 14'	0.311
8	.	187° 20'	0.329
9	.	85° 26'	0.311
10	.	202° 20'	.
11	.	82° 40'	.
12	.	209° 40'	.
13	.	352° 48'	.
14	.	23° 40'	.
15	.	352° 48'	.
16	.	23° 40'	.
17	.	130° 21'	0.39
18	.	199° 42'	0.311
19	.	319° 03'	0.453

AREA TO BE ADDED
IN STRATA

- Lot 591 (3, 8-13-14-15-20-4) 158m²
- Lot 600 (11-12-16-17) 3m²
- Lot 601 (9-10-18-19) 3m²
- Lot 602 (6-7-21-22) 3m²
- TOTAL LEASE AREA... 167m²

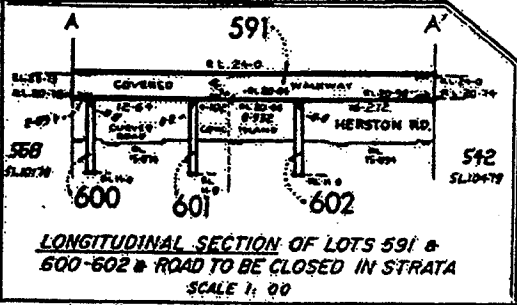
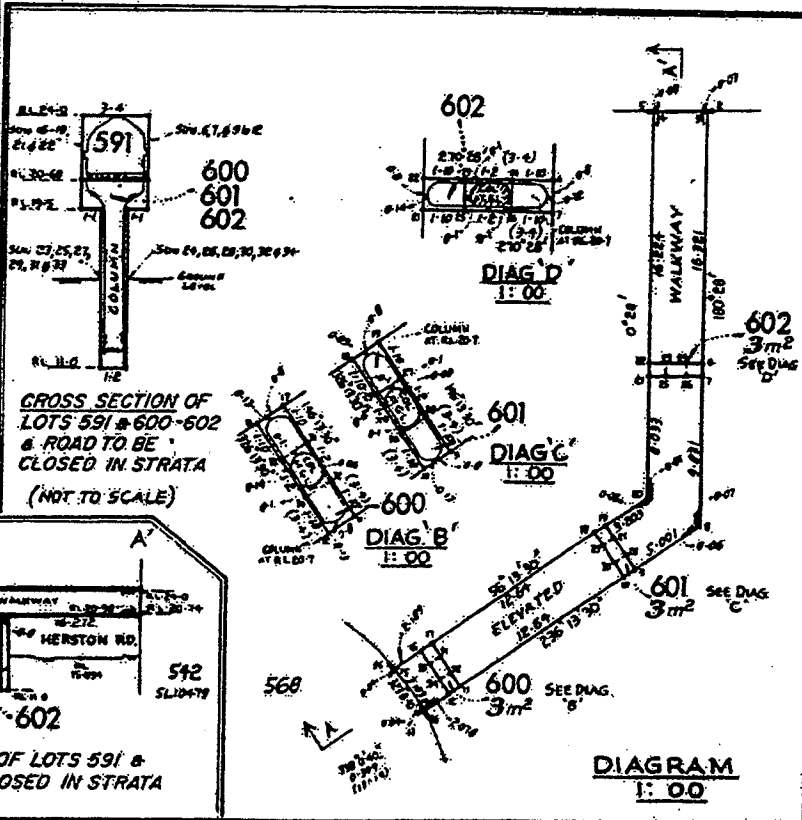

I, Mark Alan Surveyor
do hereby certify that I have personally examined the
"as-shown" in this plan (except primary changes)
and that the plan is correct, that the said survey was
performed in accordance with the provisions of the
Surveyors Regulation, and that the said survey
was completed on 5/12/92.

Mark Alan
Surveyor

PLAN OF Lots 591, 600-602 in Strata

PANISH NORTH BRISBANE
COUNTY Stanley
LOCALITY HERSTON
LOCAL AUTHORITY BRISBANE C.C.
LAW JURISDICTION
DISTRICT

ORIGINAL PORTIONS 542 & 568

MERIDIAN	MAP REF	SCALE	FILE REF	ENDORSED	REGISTERING DIST
CAH Year	C.C.78	1:1000	Ref 86-20		BRISBANE

EXAMPLE 37

- NOTES:
1. Special Statement on face to indicate Level Datum – referenced to A.H.D.
 2. Wording of Action Statement for Road to be Closed.
 3. Subterranean boundaries shown as broken lines (similar to Easements).

Tenure in Strata

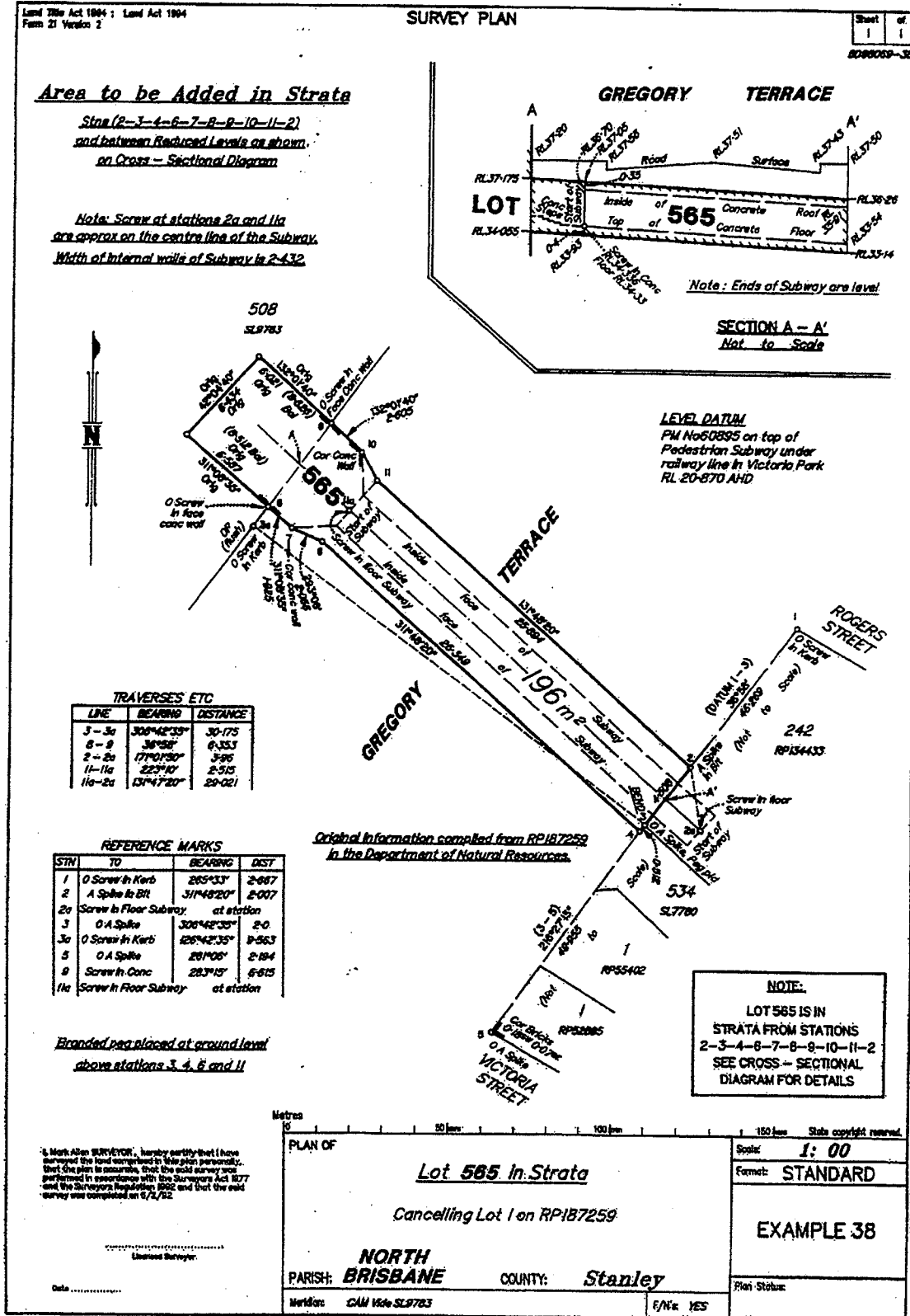

NOTES:

The method of representing Cross Sectional diagrams, etc, is Road Closure in Strata is limited by RLs based on registered Bench Mark referenced to A.H.D.

Unmarked Lines and Corners

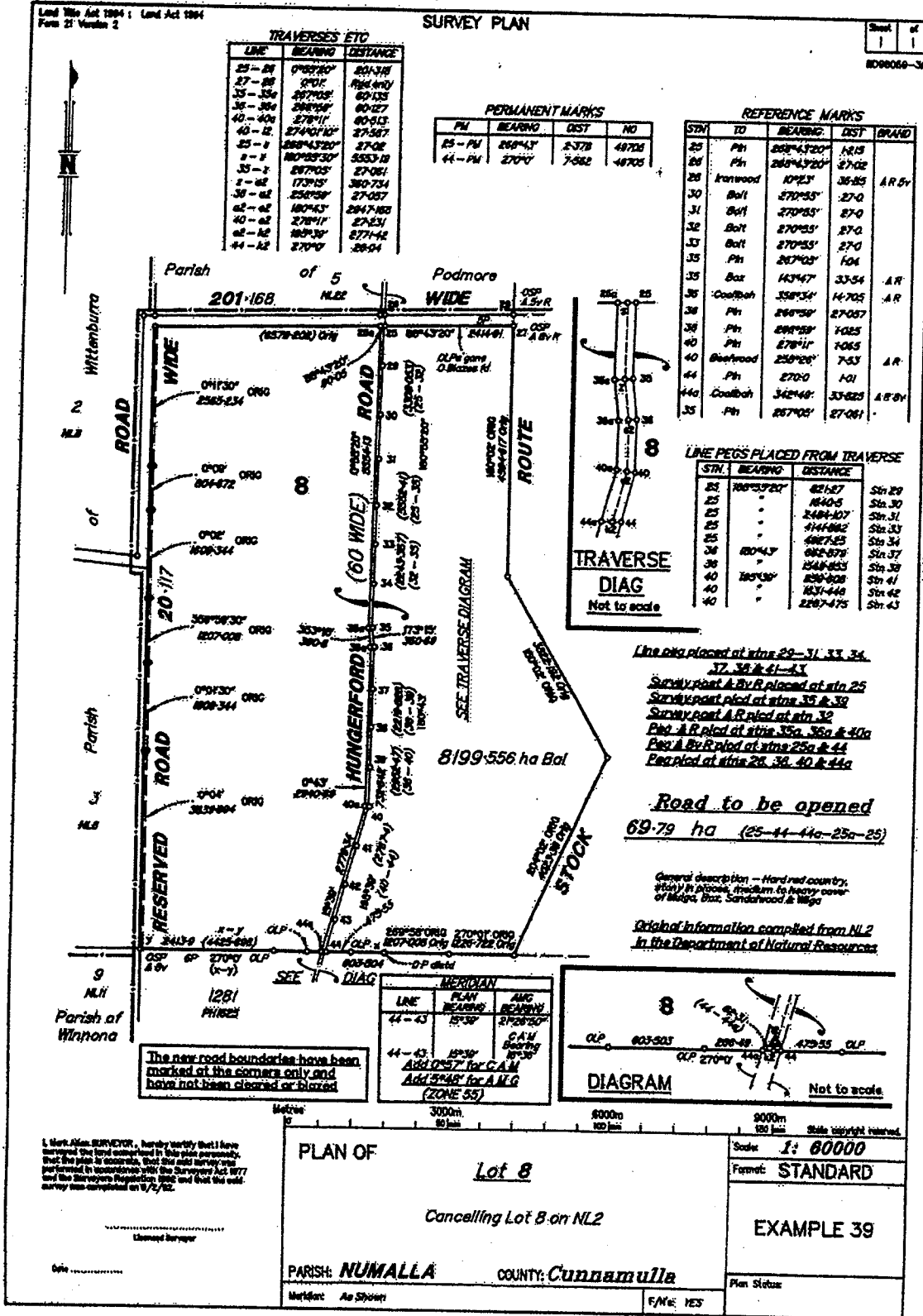

This page intentionally left blank

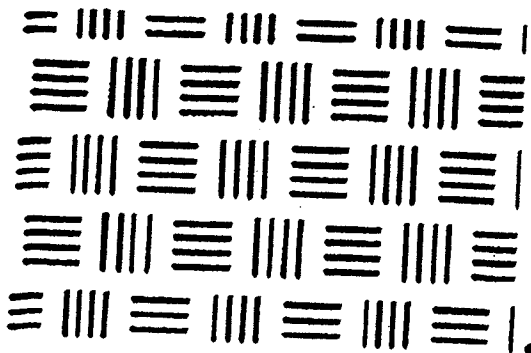

Requirements of the Department of Mines & Energy

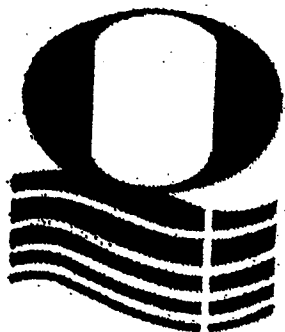
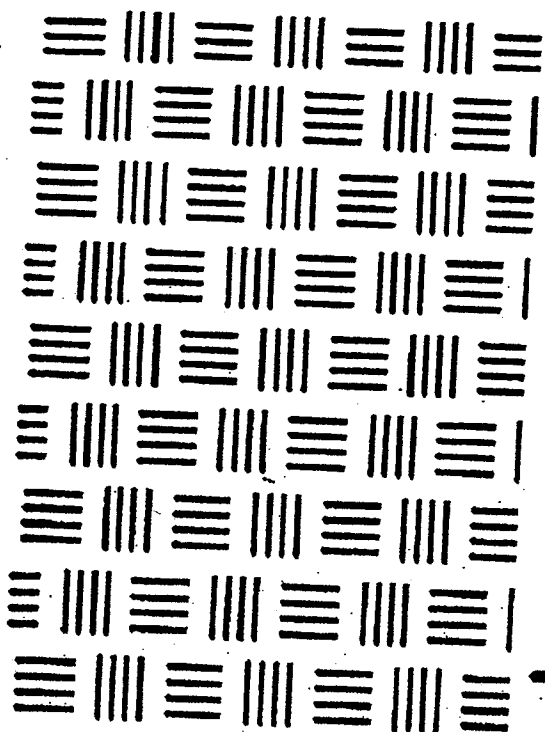

Outlining the requirements as set down by
the Department of Mines and Energy

Specimen and Example Plans.

Department of Mines & Energy

**GPO BOX 194
BRISBANE Q 4001**

Phone: (07) 3237 1601

Fax: (07) 3237 1634

Att: Chief Surveyor

A plan of survey of a Mining Lease may be lodged subject to the Surveyor complying with the Mineral Resources Act 1989 and the Mineral Resources Regulations 1990.

Specimen Plans indicate as far as possible most requirements of the Department. However specific actions would be detailed by the Chief Surveyor in the survey instructions.

If doubt exists, the Chief Surveyor Department of Mines & Energy should be contacted.

INDEX

A	Access To Mining Leases - See Right of Way	3.15
	Application Posts - See Mining Lease	3.12.3
	Areas	3.1
	Authority To Prospect - See Exploration Permit	3.7
B	Background Tenures	3.2
C	Certificates	3.3
	Claims And Areas	3.4
	Compiled Plans	3.5
D	Datum Post	
	see Mining Lease	3.12.4
	see Compiled Plans	3.5.5
	Depth Restrictions - See Mining Lease	3.12.5
E	Excisions - See Mining Lease	3.12.7
	Exploration Permit (EP)	3.7
F	Field Notes	3.8
H	Handbook For Resource Industries Surveys	3.9
I	Identification Survey	3.10
L	Lapsed Boundaries	3.11
M	Mineral Development Licence - See Mining Lease	3.12
	Mining Lease	3.12
P	Petroleum Permits, Leases And Licenses	3.13
	Plan Forms - See	E4-40
R	Resumptions - See Mining Lease	3.12.8
	Resurveys - See Identification Surveys	3.10
	Right Of Way	3.15
	Roads In Mining Leases	3.16
S	Special Franchise Agreements - See Relevant Acts	
	Specimen Plan	Specimen Plan Nos 1 & 2
	Status Of Tenure Table	3.17
	Statutory Mine Working Plans	3.18
	Surface Areas - See Mining Lease	3.12.2
	Surrenders - See Mining Lease	3.12.7
	Survey Records - See Field Notes	3.8
T	Title	3.19
U	Undescribed Balance	3.20
V	Vinculum	3.21

GENERAL NOTE

Type and Line Styles should be standardised appropriate for industry standard electronic (computer) production of plans.

3.1 Areas

Areas are computed in accordance with General Requirements 1.8.

Should a "three line" area be involved, the exclusion may be shown by statement and providing all bearings and dimensions are shown -- or may be inferred by a reference to a previous plan, the Nett area only is shown on the plan.

See also 3.16 Roads In Mining Leases

Where more than one previous plan is involved, to avoid ambiguity in Datum and dimensional differences, the subject plan should be fully dimensioned.

3.2 Background Tenures

3.2.1 Where a Mining Tenement covers lands held under other tenures, all boundaries and descriptions of those lands are to be shown on the plan. The boundaries of the subject block are to be distinguished by heavier lines. Show underlying descriptions in light block as follows:

Sample

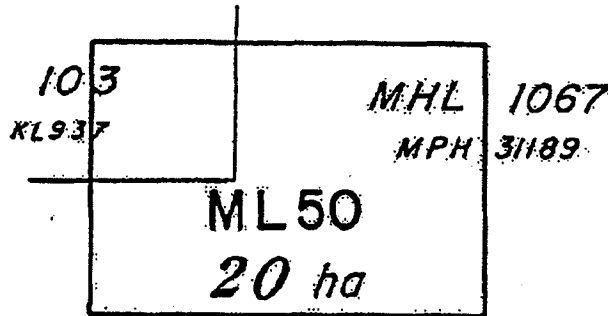

3.2.2 When surface rights exist severances and connections are required. See- E4-17

3.3 Certificates

3.3.1 Certificate Required For Mineral Resources Plan

..... hereby certify that I/the Company have surveyed the land shown in this plan (either personally or by whose work I/the Company accept responsibility), that the plan is accurate, that the survey was performed in accordance with the Mineral Resources Act 1989 and the Regulations made thereunder, and that the survey was completed on

Approved Surveyor

Date

3.3.2 Certificate Required For Petroleum Well Location Plan

(*) hereby certify that I/the Company have surveyed the location of the petroleum well as shown in this plan, that the plan is accurate, that the survey was performed in accordance with the Petroleum Act 1923 and the Petroleum Regulations (Land) 1966 and that the survey was completed on

Approved Surveyor

Date

(*) Insert full name of Approved Person

3.4 Claims And Areas

Claims and Areas as defined by the Mineral Resources Act are registered by the Mining Registrar and generally are not surveyed. Where surveyed, show as for Mining Lease requirements.

3.5 Compiled Plans (Plans Without Field Survey)

3.5.1 Prior approval of the Chief Surveyor must be obtained for all compiled plans.

3.5.2 Information may be compiled from examined Department of Mines & Energy, and Department of Natural Resources plans only. Dimensions are not qualified by the word "Orig." Station Nos. or letters are shown only when required to describe specific actions (i.e. Additions etc.)

3.5.3 If a compiled surround closes within the allowable limits of error, a calculated area should be used. If not, a compiled area is to be used and labeled where applicable "Bal"

3.5.4 Compiled Plans Involving Existing ML's

Compiled plans involving actions on existing ML's must bear the following statement:

Sample

*Copied and compiled from (Plan No/s) in the *Department of Mines & Energy Brisbane*

(*) Substitute or add "Department of Natural Resources" where applicable.

3.5.5 Compiled Plans Involving Unsurveyed ML's

- 3.5.5.1** Compiled plans involving new ML's must bear a Section 25 certificate to which should be added:

Sample

and that the Datum Post was found by inspection to agree with the Lease Application as shown hereon.

.....
Licensed Surveyor

- 3.5.5.2** Compiled plans of ML's must show "Datum Post" on the face of the plan, with a connection from the appropriate lease corner tabulated as per the reference shown on the application.

An accurately measured connection is not required.
See also E4-20.

- 3.5.6** Where the compilation of plans cannot meet the requirements of 3.5.2 directions from the Chief Surveyor should be sought.

- 3.5.7** For private compiled plans the "DRAWN" box should be amended to "COMPILED BY"

- 3.5.9** The title of the plan is the same as if it were a survey.

3.6 Consolidated Leases

See E4-20.

3.7 Exploration Permit

- 3.7.1** On plans showing a point, line or area of an EP, the sub-block corners of which are described by geographic co-ordinates, the datum of the co-ordinates should be stated on the face of the plan as follows :

Sample

Geographic Co-ordinates on
Australian Geodetic Datum
eg. AGD 84

- 3.7.2** All bearings should be referred to the True Meridian.

- 3.7.3** When bearings are given, both forward and reverse azimuths must be shown where applicable.

- 3.7.4** If geodetic points are not available in the district at the time of survey, and an EP corner is determined by astronomical observations, a certificate signed by the holder and all adjoining EP holders, agreeing to accept the boundaries as located, must appear on the plan.
- 3.7.5** Plans of EP surveys should show connections to cadastral boundaries and comparison of meridians where practicable. Where observations are taken, a meridian table should be shown, vide "MERIDIAN" 1.42
- 3.7.6** In the Title Block a full Tenure description is applicable.
- Exploration Permit - Mineral No 123 (On face "EPM" may be used)
 - Exploration Permit - Coal No 123 (On face "EPC" may be used)
 - Authority to Prospect - Petroleum No 12 (On face "APP" may be used)

3.8 Field Notes

Complete statement on plan form as follows:

eg. (a)

NO FIELD NOTES LODGED

eg. (b)

FIELD NOTES LODGED 26.1.88

See also E4-32.

3.9 Handbook For Resource Industries Surveys

Guidelines for survey requirements for actions effected under the Acts administered by the Department of Mines & Energy are reproduced as Part E4.

3.10 Identification Survey

- 3.10.1** Plan requirements for boundary identification survey of all or part of any existing mining tenement are the same as the plan requirements for a survey of that tenement: except that the plan title should be headed:

Sample

IDENTIFICATON SURVEY OF

- 3.10.2** Identification Surveys to be drawn on Department of Mines & Energy plan forms.

3.11 Lapsed Boundaries

3.11.1 Lapsed boundaries are previously cancelled boundaries or boundaries of dead leases.

They are generally only shown when used for survey reinstatement. Measured bearings and distances are shown on face of plan. Former description of the expired lease when required is shown in dotted hairline.

See also "LINEWORK" E2--46 1.38

3.12 Mining Lease

3.12.1 New Mining Lease

3.12.1.1 A plan of a new Mining Lease must show the external boundaries of the Lease, the area held under Surface Rights, any background tenures, and the Access to the Lease when applicable.

3.12.1.2 When Surface Rights exist, severance and connections to the background tenures are required.

Sample

Surface Area : whole

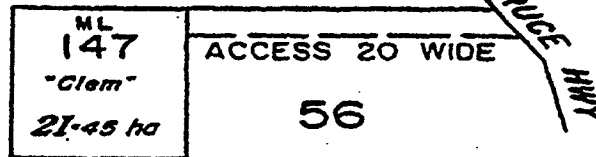

Title : *ML 147 AND ACCESS*

3.12.1.3 For details regarding Surface Area see 3.12.2.

See also "BACKGROUND TENURES" 3.2

3.12.1.4 For details regarding Access see "RIGHT OF WAY / ACCESS" E2-143 3.15

3.12.2 Surface Areas

3.12.2.1 The Surface Area (whether whole, part, or nil) is shown on the plan by statement, but must accord with the application description.

Samples

eg.

SURFACE AREA WHOLE

or

SURFACE AREA 25.75 ha (Stn Nos to be used)

or

SURFACE AREA N/L

3.12.2.2 When more than one Surface Area is contained within the one Lease, describe as Surface Area No.1 etc. A calculated area is shown for each and the areas of the total surface by statement.

When a past description has been described only as "Surface Area" a subsequent area should be described as Surface Area No.2 - See 3.12.2.3.

3.12.2.3 Shown on plan as follows: :

Sample

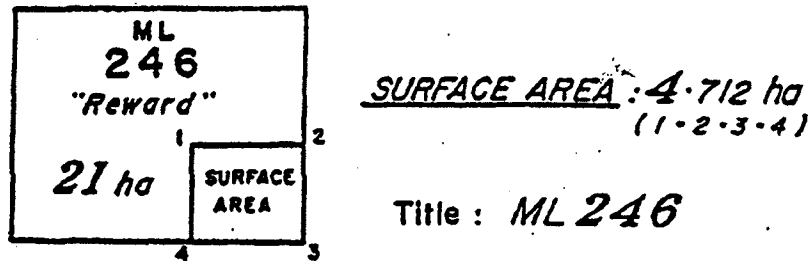

3.12.2.4 Surface Area is referred to in title when the plan is of the Surface Area only. When the Surface Areas are not contiguous, number new areas consecutively. See Also 3.12.2.5

Sample

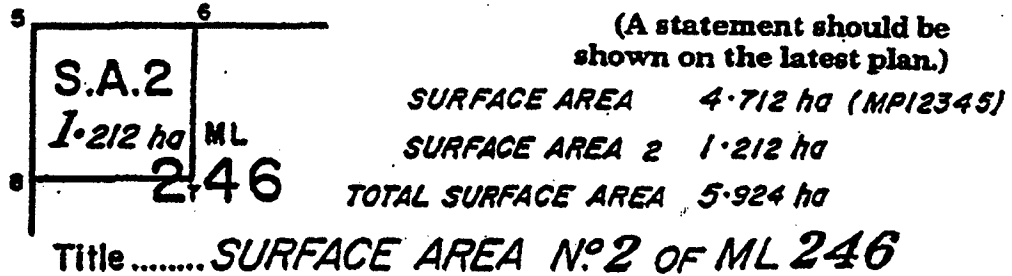

3.12.2.5 A compiled plan may be requested to show the Surface Area actions progressive.

Sample

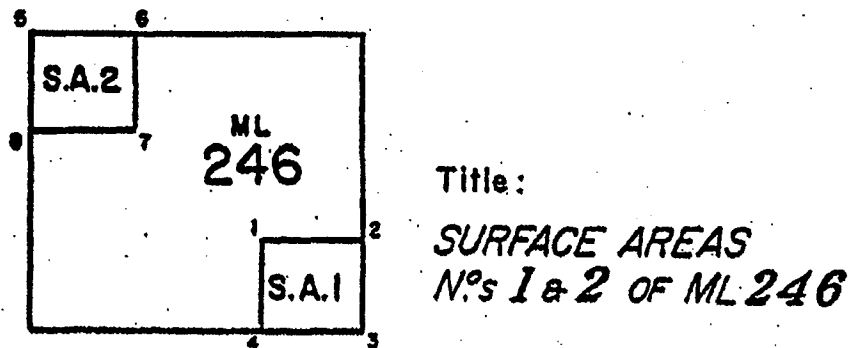

3.12.3 Application Posts

Show Connections to Applications Posts and the markings thereon, either on the face of the plan or tabulate.

3.12.4 Datum Post

All plans of Mining Leases, surveyed or compiled, may describe the position of the applicant's Datum Post and the marking thereon either on the face of the plan or tabulate.

Application Posts should be included in the same tabulation

See also "COMPILED PLANS" 3.5.5.2

3.12.5 Depth Restrictions

On plans of Mining Leases which are restricted in depth, the plan should be endorsed with a suitable statement.

Sample

MLL 69 7 exists only below the depth of 15.24 m beneath the surface except for Lot 83 where it exists on and beneath the surface

3.12.6 Name Of Lease

The name of the Mining Lease is shown within the subject block as illustrated by diagrams in 3.12.1.2 and 3.12.2.3 above.

3.12.7 Surrender From Mining Lease

The plan is drawn as if the action were completed (original dimensions and cancelled boundaries if required).

Each Severance Area being surrendered from the Lease and Surface Area, as well as the Total Area surrendered are to be shown on the plan.

For Balance Areas see "Undescribed Balance" E2--146 3.20

Sample

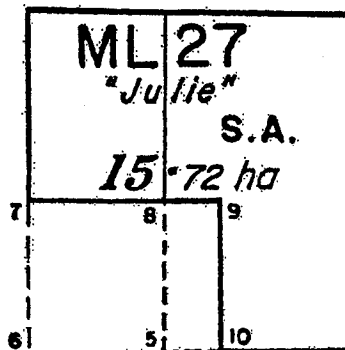

AREA TO BE SURRENDERED FROM SURFACE AREA OF ML 27

(5-8-9-10) **1.674 ha**

AREA TO BE SURRENDERED FROM ML 27

(6-7-9-10) **5.023 ha**

Title : **ML 27**

SURFACE AREA : 10.72 ha

3.12.8 Resumption From Surface Area Of Mining Lease

Treat in a similar manner to Surrenders - stating purpose.

Sample On face e.g.

AREA TO BE RESUMED FROM ML50 ... (stn NS) ... 2.745ha

Title e.g.

ML 50

The statement must clearly show whether the resumption is from the Lease (Surface and Underground) or from the Surface Area Only.

3.12.9 Mining Lease Encroaching On Mining Homesteads

The severance areas of any prior MHPL (and MHL) covered by the ML are to be stated on the plan, and shown as follows:

Sample *Area of ML in MHPL ... (Stn NP's) ... 2.345 ha*

3.12.10 Mining Lease Location Surveys

Specifications for plans of Datum Post Location Surveys are available from the Chief Surveyor on request.

3.12.11 Any Mine workings, structures or improvements on or adjacent to boundaries must be noted in the field book and shown on the plan. Care should also be taken to comply with further Dept B Instructions.

See also "ROADS IN MINING LEASES" E2—144 3.16

3.12.12 Mineral Development Licence

Mineral Development Licences as defined by the Mineral Resources Act may be lodged at the office of the Director General, Brisbane. When surveyed, generally shown as for Mining Lease requirements.

3.13 Petroleum Permits, Leases & Licenses

Whether for the purposes of the Petroleum Act 1923 - 1988, or the Petroleum (Submerged Lands) Act 1967 - 1982, it is necessary to determine the position on the surface of the earth of a point, line or area. Such a position shall be determined by reference to the Australian Geodetic Datum, and any plan depicting such position should be endorsed :

Eg. Australian Geodetic Datum 1984

Where bearings are given, both forward and reverse azimuths must be shown where applicable.

3.14 Petroleum Well Location Surveys

See E4-58

3.15 Right Of Way (Petroleum Act) Access (Mineral Resources Act)

3.15.1 "Access" is defined as access to any Mining Tenement.

3.15.2 Normally not surveyed (only when instructed by the Warden or Director-General).

3.15.3 Treat generally as for an Easement Survey.

Show width of Access and secants.

Generally no area is required.

3.15.4 If only one side is run show the surveyed boundary by a full line and the opposite side in a broken line.

3.15.5 Shown on plan as follows :

Sample On Face

eg. ACCESS 20 WIDE

Title (as the case dictates).

eg. ML 53 and ACCESS

or ML 's 52, 53 and ACCESS (ML53)

or ACCESS (ML 53)

- 3.15.6** A "Right of Way" showed access to a mining tenement on private land and after 1st August 1982, also to a mining tenement on Crown Land.

Prior to 1st August 1982, access to a mining tenement on Crown Land was described as "Right of Access".

3.16 Roads In Mining Leases

- 3.16.1** There are four methods of showing areas of Dedicated Roads and/or other exclusions or reservations through ML's on a plan, depending upon the form of the ML Application.

- 3.16.1.1** The road may be included in the surface area of an ML if compensation requirements to disturb the surface have been satisfied.

See also E4-44.

Sample

120.5 ha

The road boundaries are shown in light lines.

- 3.16.1.2** The road may be excluded from the ML in the terms of the lease.

Sample

120.5 ha

2.746 ha Rd (show by statement with Str No.s)

117.8 ha (only Area shown on face of plan)

The road boundaries are shown in heavy lines.

Join the severances with a vinculum. See 3.21.1

- 3.16.1.3** The road may be excluded only from the surface area of the ML in the terms of the lease.

Sample

Within Lease On Face

120.5 ha

by Statement

SURFACE AREA: 70.5 ha

2.746 ha Rd

67.954 ha

The road boundaries are shown in medium lines.

The surface area is shown by statement.

- 3.16.1.4** Where no surface area is required for the ML, the area of the road is not shown, only the area of the ML.

Sample

120.5 ha

The road boundaries are shown in light lines.

See also "AREAS" 3.1

3.16.2 In all cases the surveyed road boundaries should be plotted on the plan.
Full dimensions of the road are required in cases 3.16.1.2 and 3.16.1.3 above.

3.17 Status Of Tenure Table

Plans drawn for the purpose of a grant must show a tenure table. To avoid confusion over the status of a grant, the description of a plan must not be qualified by the term "A" or "Application". The tenure table will be completed by the Department at date of grant.

Sample

STATUS OF TENURE

TENURE No.	DATE OF GRANT
ML 4059	

3.18 Statutory Mine Working Plans

3.18.1 Drawing requirements for Statutory Mine Working Plans will be made available from the Chief Surveyor on request.

3.18.2 Plans must be drawn on official Department of Mines & Energy Statutory Mine Working Plan sheets, obtainable from the Chief Surveyor.

3.19 Title

3.19.1 Should be shown on plan as follows :-

(a) PLAN OF *ML 1275*
For further details refer to respective tenure.

(b) PARISH *GYMPIE*

(c) COUNTY *March*

(d) MINING DISTRICT..... *Mareeba*

See also "STYLES" 1.62

See also "SPECIMEN MINING RESOURCES PLAN" No I

3.20 Undescribed Balance

In the case of an excision from a Surface Area or Mining Lease the Balance must be shown on the plan where possible. The Balance may be left as an Undescribed Balance and omitted from the plan only with the prior approval of the Chief Surveyor.

3.21 Vinculum

A Vinculum symbol binding Severances of tenements across intervening boundaries, or over other lands, are to be shown on face of plan thus:

3.21.1 For Subject Land



3.21.2 For Surface Areas, Sub Lease Etc. Over The Subject Land.



3.21.3 For Background Descriptions Underlying The Subject Lease And For Adjoining Descriptions.

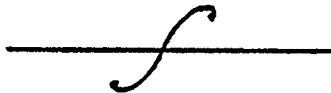

Specimen Plan

DIAGRAM B.

Scale 1:2000

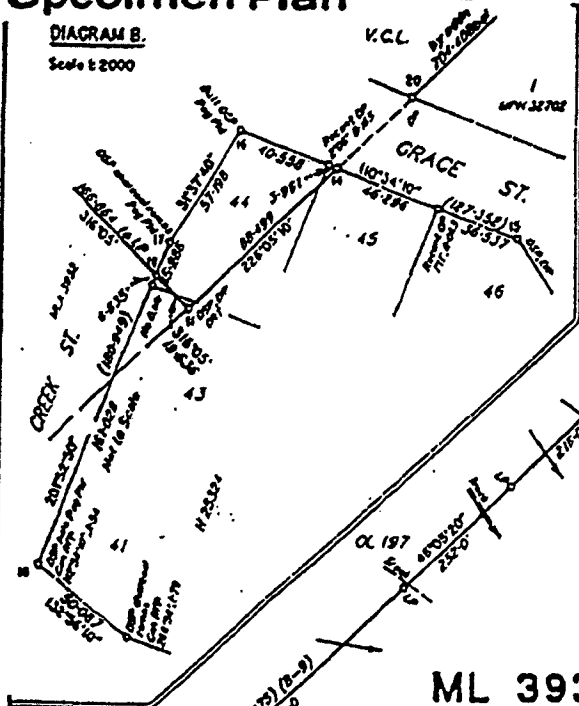

Surface Area (2-3-5-X-6-7-8-9-10-12-13-2) 82.86 ha
 Area to be surrendered from ML 3931 (10-12-13-Y-11-10) 33.59 ha
 Area to be surrendered from Surface Area of ML 3931 (10-12-13-Y-14-16-17-18-10) 33.34 ha
 Branded survey res placed at sta: 8-10, 12 & 13
 Branded res placed at sta: 7 & 16-18
 Res placed at station 14 & 19

Original information compiled from plan
 MP 40127, MP 35273, MP 32702, MP 30734, MP
 34453 in the Department of Minerals and
 Energy, Brisbane.

ML 3931
 "Empress"
 82.86 ha

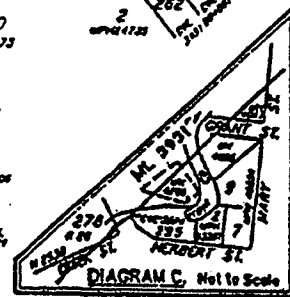
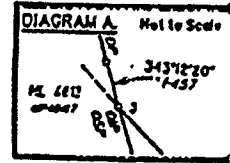

TRAVERSES ETC

LINE	BEARING	DIST
J-7	31°03'20"	103.184
K-20	48°05'10"	44.808

PERMANENT MARKS

PM	BEARING	DIST	NO
K-PM	53°26'10"	2.077	102870

DATUM POSTS

STN	BEARING	DIST	REMARKS
P-Post	at	6th	(See MP 40127)

LEASE POSTS

POST	BEARING	DIST	REMARKS
P - Post	4°11'	6.173	"MPL 7620 21-4-80" "MPL 7619 21-1-80"

STATUS OF TENURE

TENURE NO	DATE OF GRANT
ML 3931	

MERIDIAN

LINE	PLAN BEARING	A.M.C. BEARING
J-2	136°05'20"	136°05'20"

Subtract 3°43' for CAU - ZONE 55

REFERENCE MARKS

STN	TO	REMARKS	BEARING	DIST
1	OP	MP 40127	31°03'20"	10
2	ORT	MP 34453	0°47'10"	6.33
3	OP	MP 34453	136°05'20"	105.3
4	OP	MP 34453	163°12'20"	0.668
5	OP	MP 40127	163°12'20"	10
6	ORT	MP 40127	22°13'20"	15.59
7	OP	MP 40127	34°12'20"	10
8	ORT	MP 40127	163°12'20"	121
9	OP	MP 40127	37°13'20"	11.46
10	Pin		32°17'20"	0.003
11	Pin		34°10'10"	3.023
12	Pin		48°05'20"	10
13	Pin		31°03'	10
14	OP	MP 32702	137°07'10"	0.88
15	ORT	MP 32702	1°16'10"	3.81
16	Pin		48°05'	10
17	OP	MP 34453	136°05'20"	1.36
18	ORT	MP 34453	170°25'10"	6.83
19	OP		30°35'10"	1.0
20	Pin		336°00'10"	14.3
21	Pin		300°31'10"	157
22	Pin		147°07'10"	0.221

I, Mark Allen Surveyor
 certify that I have personally surveyed the land shown in this plan in accordance with the provisions of the Mining Resources Act 1988 and the Regulations made thereunder, and that the survey was completed on
 Date: 1984

MINING SURVEYED BY
 I, Mark Allen Surveyor
 on the 17th 22nd 85
 Length 145 22 85
 (FILED NOTES (MNH))

MINING RESOURCES PLAN
 of ML 3931 (formerly ML 5246, Herberton)
 PARISH: HERBERTON
 COUNTY: Cardwell
 MINING DISTRICT: MAREEBA
 SEE TABULATION 1:000 SPECIMEN 1

Specimen 2 Plan Deleted

STATUS OF TENURE	
TENURE No	DATE OF GRANT
ML 20103	14/10/89
ML 20102	14/10/89
ML 20103	14/10/89

NOTES

1. Branded Survey Post placed at stations 51-53, 55, 56, 59-66.
2. Steel Star Picket placed at stations Ja, 51a, 52a, 53a, 56a, 63a, 64a & 65a.
3. Refer field notes for old workings.
4. SURFACE AREA ML20099 - WHOLE
5. SURFACE AREA ML20102 (Excludes Road in 4 Below) Abl 54.27 ha
6. SURFACE AREA ML20103 (Excludes Road in 4 Below) Abl 57.25 ha
7. Area of Road within ML 20099 (G-60-F-J-H-G) Abl 3.47 ha
8. Area of Road within ML 20102 (64-M-T-64) Abl 0.53 ha
9. Area of Road within ML 20103 (64-S-M-64) Abl 0.25 ha
(R-K-F-N-R1) Abl 2.25 ha } Abl 2.5 ha
10. This is one of two plans (Catalogue Nos. MP36196 & MP36197 from the one survey).

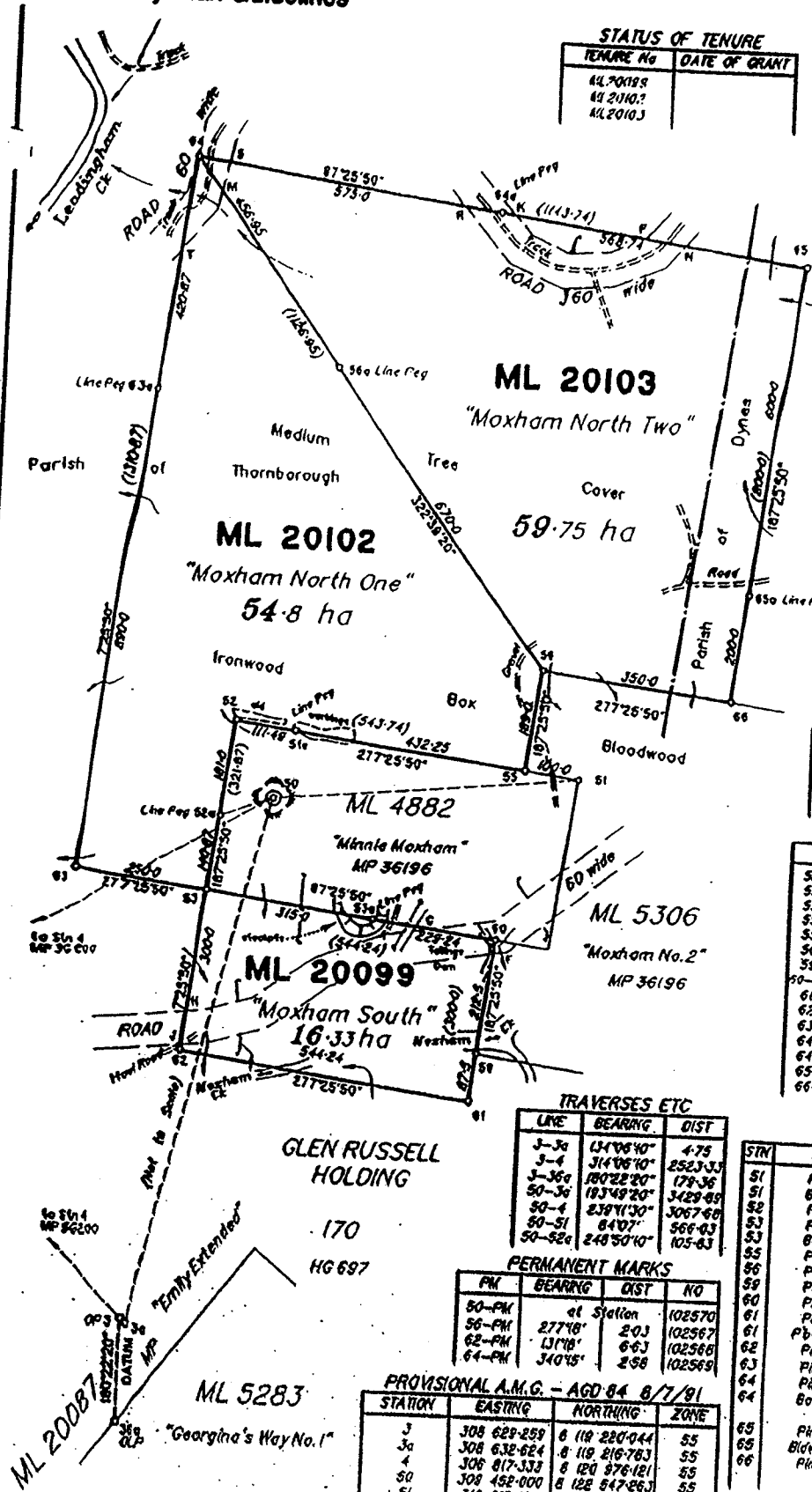

DATUM POSTS			
LINE	BEARING	DIST	BRAND
51-Post	277°25'50"	0.2	(MAM 10/12/87)
56-Post	298°0'	0.45	(MCL 6/8/91)
56-Post	310°0'	0.5	(MCL 6/8/91)
60-Post	325°	30.65	(MCL 6/8/91)

LEASE POSTS			
LINE	BEARING	DIST	BRAND
52-Post	277°25'50"	5.7	(MCL 6/8/91)
53-Post	352°40'	21.45	(MCL 6/8/91)
53-Post	352°0'	21.55	(MCL 6/8/91)
55-Post	292°50'	0.3	(MAM 10/12/87)
55-Post	298°50'	0.5	(MCL 6/8/91)
56-Post	277°25'50"	0.25	(MAM 10/12/87)
59-Post	277°25'50"	0.3	(MAM 10/12/87)
59-Post	277°25'50"	0.24	(MAM 10/12/87)
61-Post	8°0'	27.2	(MCL 6/8/91)
62-Post	8°40'	21.8	(MCL 6/8/91)
63-Post	17°0'	5.25	(MCL 6/8/91)
64-Post	232°40'	17.65	(MCL 6/8/91)
64-Post	232°20'	17.75	(MCL 6/8/91)
65-Post	8°20'	6.15	(MCL 6/8/91)
66-Post	82°50'	6.8	(MCL 6/8/91)

TRAVERSES ETC		
LINE	BEARING	DIST
J-3a	134°06'40"	4.75
J-4	314°06'40"	2523.33
J-36a	180°22'20"	179.36
50-3a	183°48'20"	3429.89
50-4	238°11'30"	3067.60
50-51	84°07'	566.03
50-52a	240°50'10"	105.63

PERMANENT MARKS			
PK	BEARING	DIST	NO
50-PK	at Station		102570
56-PK	277°18'	2.03	102567
62-PK	131°18'	6.63	102568
64-PK	310°45'	2.58	102569

PROVISIONAL A.M.C. - AGO 84 8/7/81			
STATION	EASTING	NORTHING	ZONE
J	308 629-259	8 118 220-044	55
3a	308 632-624	8 118 216-783	55
4	308 817-333	8 120 876-121	55
50	308 452-000	8 122 847-263	55
51	310 015-030	8 122 605-273	55

REFERENCE MARKS				
STN	TO	REMARKS	BEARING	DIST
51	Pin	A ML4882	85°15'	1.675
51	Box		161°27'	22.89
52	Pin		87°25'50"	1.0
53	Pin		87°25'50"	1.1
53	Box	A ML4882	166°0'	20.26
55	Pin		166°0'	1.15
56	Pin		72°55'50"	2.0
59	Pin		204°41'	1.4
60	Pin		270°55'	1.44
61	Pin		87°25'50"	4.6
61	P/bark	A ML20099	38°50'	1.82
62	Pin		136°15'	3.71
63	Pin		167°25'50"	2.025
64	Pin		87°25'50"	1.66
64	Box		121°40'	0.87
65	Box	A ML 20102/20103	231°55'	7.83
65	Pin			
66	Bl'dwd	A ML20103	358°43'	2.02
66	Pin		168°20'	5.75
66	Pin		85°14'	6.77

I, Mark Allen Surveyor
 hereby certify that I and my Company have surveyed the land shown in this plan (either personally or by my-
 or whose work in the Company is accepted responsibility), and that the plan is accurate, that the survey was performed in accordance with the Mineral Resources Act 1989 and the Regulations made thereunder, and that the survey was completed on _____

Approved Surveyor: _____ Date: _____
 CATALOGUED APPROVED REGISTERED
 Surveyor

LOCALITY
 S 16° 58' 21" E
 51 LONG. E 125° 12' 56"

FIELD NOTES FORKED

MINING RESOURCES PLAN
 of ML 20099, ML 20102 & ML 20103

PARISH: THORNBOROUGH/DYNES
 COUNTY: Hodgkinson
 MINING DISTRICT: MAREEBA

MEETMAN AND SCALE: 1:000

EXAMPLE 1

STATUS OF TENURE	
TENURE	DATE OF GRANT
ML 6961	

Datum Post was found by inspection to agree with the Lease Application as shown hereon.

Licensed Surveyor

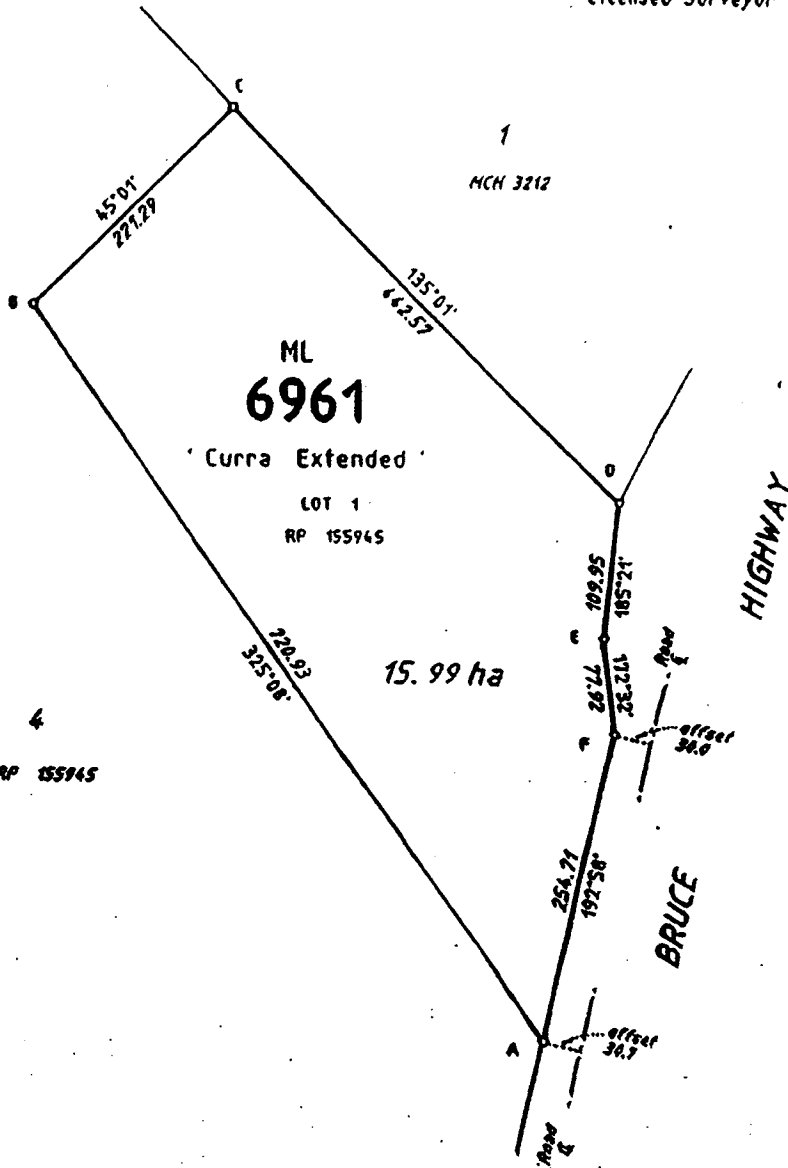

I, Mark Allen Surveyor hereby certify that I have made this plan pursuant to Section 25 of the Surveyors Regulation 1992, that the plan is accurate and compiled from plan RP155945 in the Department of Lands.

27/7/92
Date

Mark Allen
Licensed Surveyor

DATUM			POSTS
POST	BRC	DIST	RNKS
A-Post	295'0"	0.23	TLPL 31/10/89 (MLP281)

SURFACE AREA WHOLE

MINING RESOURCES PLAN

<p>I hereby certify that I/the company have surveyed the land shown in this plan (either personally or by the release work I/the company accept responsibility) that the plan is accurate, that the survey was performed in accordance with the Mineral Resources Act 1988 and the Regulations made thereunder, and that the survey was completed on <u>27/7/92</u></p> <p>Approved Surveyor <u>Mark Allen</u> Date</p>		<p>LOCALITY LAT. S <u>28° 06' 10"</u> LONG. E <u>152° 34' 20"</u> FIELD NOTES LOOKING</p>		<p>ML 6961 PARISH <u>CURRA</u> COUNTY <u>March</u> MINING DISTRICT <u>Brisbane</u></p>	
<p>REGISTERED</p>	<p>FILED</p>	<p>SCALE <u>1: 000</u></p>	<p>Meridian <u>Vide RP 155945</u></p>	<p>EXAMPLE 2</p>	

LEASE POSTS

Post	Bearing	Dist	
1-Post	164° 57'	0.33	*V. Knapke 11.6.1990*
3-Post	136° 17'	1.16	*V. Knapke 11.6.1990*
4-Post	130° 05'	2.18	*V. Knapke 11.6.1990*

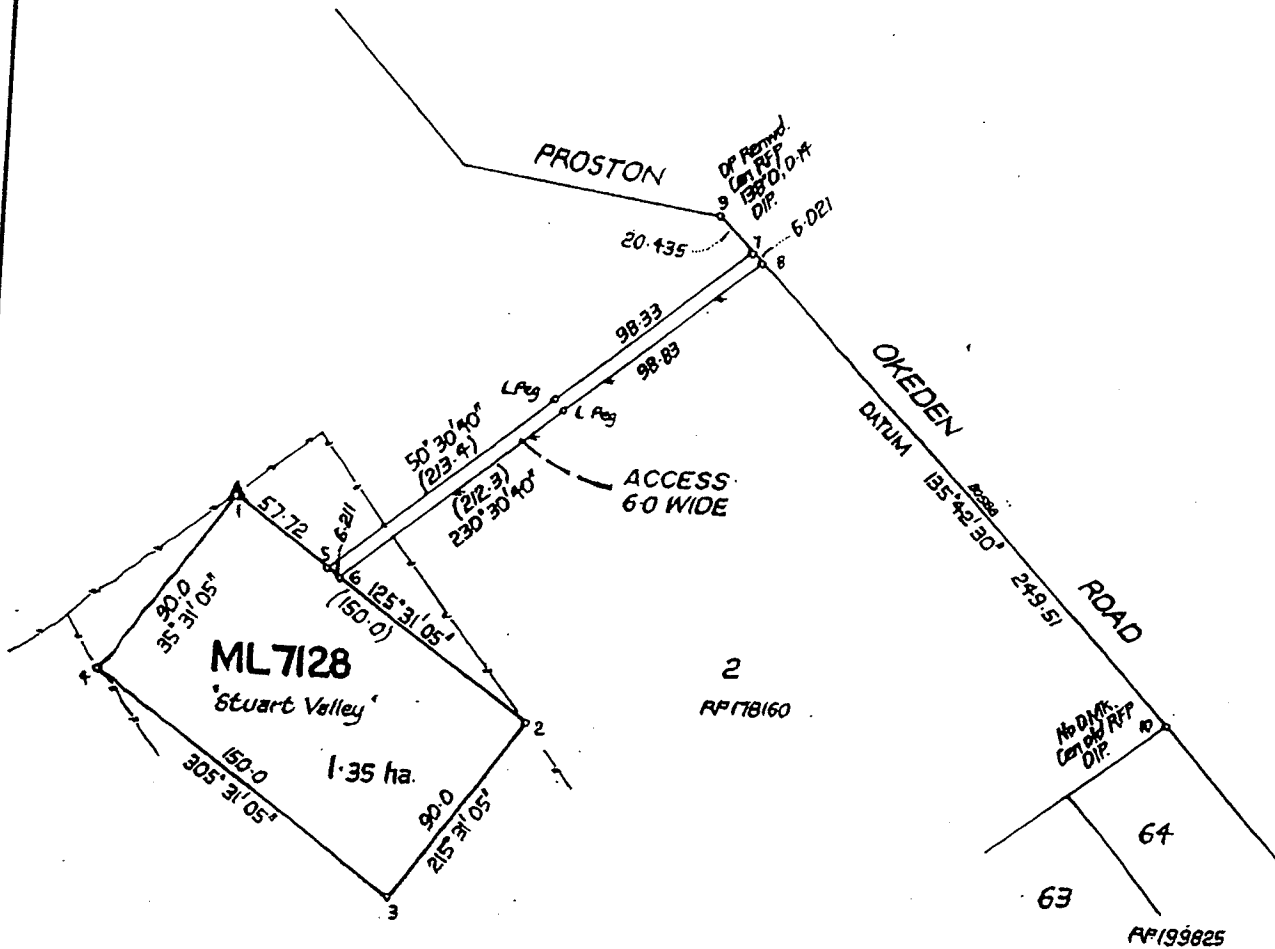

PERMANENT MARKS

PM.	Bearing	Dist	Number
1-PM	205° 16'	1.522	79822
2-PM	230° 52'	1.397	79823

SURFACE AREA - WHOLE

DATUM POST

Post	Bearing	Dist	
2-Post	219° 49'	0.23	*V. Knapke 11.6.1990*

REFERENCE MARKS

Sta	To	Remarks	Bearing	Dist.
1	Pin		305° 31' 05"	0.723
2	Pin		305° 31' 05"	0.95
3	Pin		305° 31' 05"	0.95
4	Pin		305° 31' 05"	0.723
5	Pin		125° 31' 05"	3.106
7	Pin		163° 25' 45"	3.256
9	OIP		315° 42' 30"	1.0
10	OIP		135° 42' 30"	1.0

STATUS OF TENURE

Tenure No	Date of Grant
ML 7128	12/12/91

Fog placed at stations 5-9
Survey Posts placed at stations 1-4

MERIDIAN

Line	Plan Brg.	ANG Brg.
1-2	125° 31' 05"	125° 31' 05"

AMG
Subtract 7° 23' 05" for CAM ZONE 56

<p>I, Mark Allen Surveyor</p> <p>herby certify that I/the Company have surveyed the land shown in this plan (either personally or by...)</p> <p>for whose work I/the Company accept responsibility, that the plan is accurate, that the survey was performed in accordance with the Mineral Resources Act 1989 and the Regulations made thereunder, and that the survey was completed on _____</p> <p>Approved Surveyor: _____ Date: _____</p>	<p>PWL SURVEYED BY</p>	<p>MINING RESOURCES PLAN ML 7128 and ACCESS</p>		
	<p>LOCALITY LAT. S 26° 08' 42" LONG. E 151° 25' 22"</p>	<p>PARISH <u>PROSTON</u></p>	<p>COUNTY <u>Boondooma</u></p>	
	<p>FIELD NOTES LODGED</p>	<p>MINING DISTRICT <u>Brisbane</u></p>	<p>MERIDIAN <u>AMG</u></p>	
	<p>FILE REF. _____ DRAWN _____</p>	<p>SCALE <u>1: 000</u></p>	<p>EXAMPLE 3</p>	

STATUS OF TENURE

ML	LOT	Sublease	Date of Commencement	Tenure No
7024	185			

REFERENCE MARKS

STN	TO	BEARING	DIST	REMARKS
1	OIP	216°38'40"	1.414	
2	"	89°46'20"	7.071	O-B Wood
3	"	126°38'40"	1.414	
3	Pin	306°38'40"	"	
6	OIP	126°38'40"	"	
7	"	216°38'40"	"	gone
8	Pin	261°38'40"	1.0	
12	OIP	160°00'	3.3	
12	"	"	3.32	

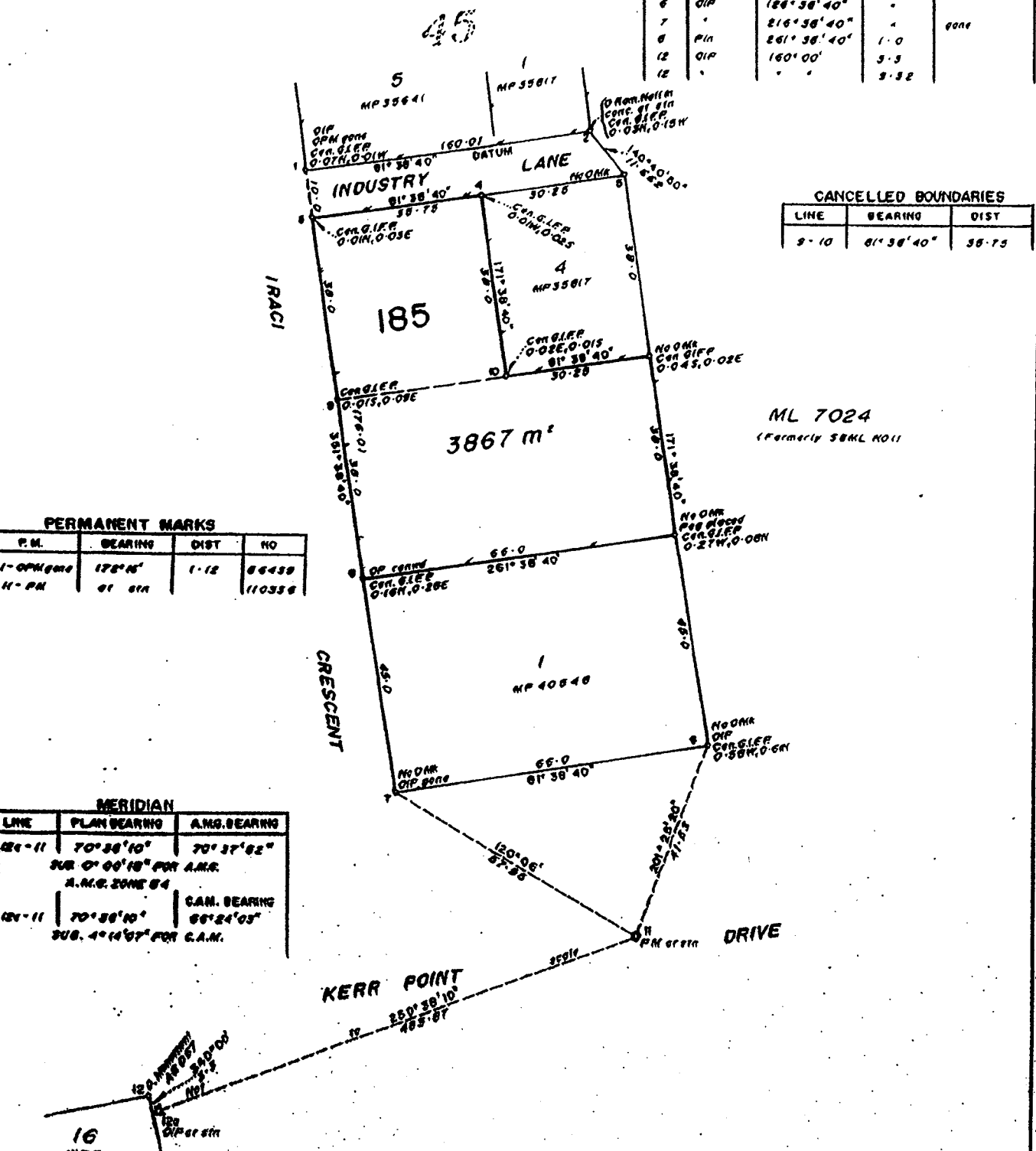

CANCELLED BOUNDARIES

LINE	BEARING	DIST
9-10	81°38'40"	38.75

PERMANENT MARKS

P.M.	BEARING	DIST	NO
1-OIP gone	178°45'	1.12	86439
11-Pin	81°01N		110338

MERIDIAN

LINE	PLAN BEARING	A.M.G. BEARING
124-11	70°38'10"	70°37'52"
SUB. 0°00'18" FOR A.M.G.		
A.M.G. ZONE 54		
124-11	70°38'10"	C.A.M. BEARING
SUB. 4°14'57" FOR C.A.M.		

COMMERCIAL AND LIGHT INDUSTRIAL SITE
LOCALITY: EVANS LANDING

NOTE: Actions for Weipa and Mt Isa only
TOWN COMMISSION OF WEIPA

<p>I, Mark Allen Surveyor herby certify that I have personally surveyed the land shown in this plan (either personally or by a competent person) and that the plan is accurate, that the survey was performed in accordance with the Mineral Resources Act 1989 and the Regulations made thereunder, and that the survey was completed on _____</p> <p>Approved Surveyor: _____ Date: _____</p>		<p>MINING RESOURCES PLAN LOT 185 Cancelling Lots 2 and 3 on MP 40548</p> <p>LOCALITY: _____ LAT. S 12° 39' 40" LONG. E 141° 51' 10"</p> <p>PARISH: FIFE COUNTY: Weipa MINING DISTRICT: Cairns</p>	
<p>CATALOGUED</p>	<p>APPROVED</p>	<p>REGISTERED</p>	<p>SCALE: 1:100</p>
<p>See Tabulation</p>		<p>EXAMPLE 4</p>	



**REQUIREMENTS
OF THE
DEPARTMENT OF
NATURAL RESOURCES**

Incorporating

SURVEY REQUIREMENTS

And

**THE REGISTRAR OF TITLES
DIRECTIONS
FOR THE
PREPARATION OF PLANS**

Note to Surveyors:

This document has been prepared based on the requirements of the Department as at the date of publication.

© The State of Queensland, Department of Natural Resources 1996

Copyright protects this publication. Except for purposes permitted by the Copyright Act, reproduction by whatever means is prohibited without the prior written permission of the Department of Natural Resources. Inquiries should be addressed to the Department of Natural Resources, Locked Bag 40 Coorparoo Delivery Centre, Coorparoo 4151.

Department of Natural Resources Office Addresses

The offices listed below are only those offices where there is a surveying function that is associated with the Department's plan registration process.

Electronic Mail may be addressed to Senior Surveyors within the department individually or as a group. Individual addresses are in the form "firstname.lastname@dnr.qld.gov.au". The group address is snrsurv@dnr.qld.gov.au.

DEPARTMENT OF NATURAL RESOURCES

Landcentre
Cnr Main and Vulture Streets,
Woolloongabba

Postal Address
Locked Bag 40
Coorparoo Delivery Centre
Qld 4151

Ph: (07) 3896 3177
Fax: (07) 3896 3562

■ Beenleigh

108 George Street
Beenleigh 4207
P.O. Box 1164

Ph: (07) 3826 0030
Fax: (07) 3826 0079

■ Brisbane

State Government Building
Cnr Adelaide and Edward Streets
Brisbane 4000
P.O. Box 1401

Ph: (07) 3227 6626
Fax: (07) 3227 8758

■ Bundaberg

Queensland Government Offices
46 Quay St. Bundaberg 4670
P.O. Box 1167

Ph: (071) 538 101
Fax: (071) 531 307

■ Bundall

1st Floor West Tower
Waterside Office Park
Holden Place Bundall 4217
P.O. Box 5096

Ph: (07) 588 5100
Fax: (07) 588 5133

■ Caboolture

Level 4
33 King Street Caboolture 4510
P.O. Box 1080

Ph: (074) 953 499
Fax: (074) 900 019

■ Cairns

Ground Floor National Mutual Tower
15 Lake Street Cairns 4870
P.O. Box 937

Ph: (070) 523 431
Fax: (070) 510 851

■ Ipswich

Hayden Commonwealth Centre
Cnr East and South Sts.
Ipswich 4305

P.O. Box 864
Ph: (07) 812 2026
Fax: (07) 810 0069

■ Mackay

1st Floor 32 - 36 Wood Street
Mackay 4740
P.O. Box 63

Ph: (079) 518838
Fax: (079) 574005

■ Maryborough

Floor 1 Horsburgh Place
314-318 Kent St. Maryborough 4650
P.O. Box 212

Ph: (071) 237 908
Fax: (071) 224 007

■ Nambour

Ground Floor
Centenary Square Building
52 - 64 Currie St. Nambour 4560
P.O. Box 573

Ph: (074) 300 900
Fax: (074) 417 473

■ Rockhampton

209 Bolshover Street
Rockhampton 4700
P.O. Box 1762

Ph: (079) 384 815
Fax: (079) 384 800

■ Roma

31 McDowall Street Roma 4455
P.O. Box 350

Ph: (076) 221 355
Fax: (076) 201 059

■ Toowoomba

QTV Place
Cnr Hume and Clopton Streets
Toowoomba 4350

P.O. Box 962
Ph: (076) 319 149
Fax: (076) 326 627

■ Townsville

3rd Floor State Gov't Bld.
Cnr Stanley and Walker Streets
Townsville 4810

P.O. Box 5318
Ph: (077) 221 201
Fax: (077) 221 125

DEPARTMENT OF NATURAL RESOURCES**Office: Postal Address: Ausdoc:**

Landcentre

Cnr Main & Vulture Sts

Woolloongabba Q 4102

Locked Bag 40

Coorparoo Delivery Centre

Brisbane

Coorparoo Q 4151

DX229

**QUEENSLAND
GOVERNMENT**

20th June 1997

To the Reader,

The Survey Requirements of the Department of Natural Resources is a compendium of requirements, based on the legislation, policy and procedures affecting cadastral surveys in Queensland.

The document distinguishes between requirements and those other provisions which provide guidance subject to the professional judgement of surveyors.

It has been prepared to provide cadastral surveyors with a guide to the requirements of the Department of Natural Resources in its role as a survey plan registering authority in Queensland.

I commend the document to you.

A handwritten signature in black ink, appearing to read 'R. Freeman'.

R Freeman

Executive Director

Land Services Program

Table of Contents

REQUIREMENTS OF THE DEPARTMENT OF NATURAL RESOURCES	1
1. GENERAL	5
1.1 ACCESS RESTRICTION LOTS (STRIPS)	5
1.2 ACQUISITION OF LAND	5
1.2.1 Freehold Land	5
1.2.2 Resumptions for Road and Transport Corridors	5
1.2.3 Resumptions for Other Authorities	6
1.2.4 Resumptions from Non-freehold Land	6
1.3 ADMINISTRATIVE ADVICES	6
1.3.1 Notice of Intention to Resume (NIR)	7
1.4 ADVERSE POSSESSION	7
1.5 RESERVATIONS IN TITLE	7
1.6 RIVER IMPROVEMENT TRUST	7
1.7 UNUSUAL CASES	7
2. ADMINISTRATIVE	8
2.1 ADMINISTRATIVE BOUNDARIES - COUNTY, PARISH AND LOCAL GOVERNMENT	8
2.2 AMALGAMATIONS	8
2.3 TITLES COMPRISING MULTIPLE LOTS	8
2.3.1 Consolidated Titles	8
2.3.2 Amalgamated Titles	9
2.4 BORDER SURVEYS	9
2.5 REJECTED PLANS	9
2.6 TRANSFERS TO THE STATE	9
2.7 WITHDRAWAL AND RE-LODGE MENT OF PLANS	10
2.8 WITHDRAWN PLANS	10
3. CONSENTS	11
3.1 DEPARTMENT OF ENVIRONMENT	11
3.1.1 Beach Protection Authority	11
3.2 DEPARTMENT OF NATURAL RESOURCES	11
3.2.1 State Land Actions	11
3.2.2 Barrier Fences	11
3.2.3 Catchment Areas	12
3.2.4 Channel/Drain Areas	12
3.2.5 Forest Entitlement Areas	12
3.2.6 Irrigation Areas	12
3.3 LOCAL GOVERNMENT	13
3.3.1 Local Government Boundary	13
3.3.2 Agreements — LG(P&E) Act	13
3.3.3 Local Government Conditional Consent	13
3.3.4 Local Government Consent	14
3.3.5 Existing Conditions of Amalgamation	15
3.3.6 Minimum Areas	15
3.4 CANALS	15
4. ALLOCATIONS	17
4.1 LOT ALLOCATIONS	17
4.2 PORTION ALLOCATIONS	17
4.3 EXISTING MORTGAGE ALLOCATIONS	18
4.4 EXISTING EASEMENT ALLOCATIONS	18

4.4.1 Benefit Easements	19
4.4.2 Encumbrance Easements	19
4.4.3 Existing Leases (LT Act)	19
4.5 EXISTING PROFIT A` PRENDRE	20
5. CORRECTIONS TO PLANS.....	21
5.1 GENERAL	21
5.2 ORIGINAL PLANS PRIOR TO LODGEMENT	21
5.3 AFTER LODGEMENT BUT PRIOR TO REGISTRATION.....	21
5.4 AFTER REGISTRATION.....	21
5.5 BUILDING UNIT AND GROUP TITLE PLANS	22
5.6 IDENTIFICATION PLANS.....	22
5.7 SURVEYOR'S BOOK	22
5.8 PATENT ERROR	22
5.9 REQUISITIONS	22
6. AMBULATORY BOUNDARIES	24
6.1 NON BOUNDARY WATERCOURSES	24
6.2 BOUNDARY WATERCOURSES	24
6.3 HIGH WATER MARK	24
6.4 CHANGES IN AMBULATORY BOUNDARIES	25
6.5 TITLE AMENDMENT FOR RIPARIAN BOUNDARIES	26
6.6 NATURAL FEATURES AS BOUNDARIES	27
7. EASEMENTS	28
7.1.1 General	28
7.2 DEFINITION OF EASEMENTS	28
7.3 EASEMENT AREAS BY BALANCE.....	28
7.4 EASEMENTS IN COMMON PROPERTY WITHIN A BUILDING	28
7.5 EASEMENTS BY COURT ORDER OVER ENCROACHMENTS.....	28
7.6 EASEMENTS BY RESUMPTION.....	29
7.7 EASEMENT DESCRIPTIONS	29
7.8 EASEMENTS IN FAVOUR OF LEASES	30
7.8.1 Easements over Reserves	30
7.8.2 Easements in Leases over Reserves for State Forest or National Park.....	30
7.9 EASEMENTS OVER STATE LAND IN FAVOUR OF FREEHOLD LAND AND VICE VERSA	30
7.10 EASEMENTS OVER UNDESCRIBED BALANCES	30
7.11 EASEMENTS OVER THE WHOLE OF A LOT.....	30
7.12 EASEMENT TITLES	31
7.13 LOCAL GOVERNMENT CONSENT	31
7.14 LONG LINE UTILITY EASEMENTS	31
7.15 NEW LOT BOUNDARIES INTERSECTING EXISTING EASEMENTS.....	31
7.16 ROAD DEDICATIONS OVER EASEMENTS	32
7.17 SUBSEQUENT PLANS OVER SURVEYED EASEMENTS.....	32
7.18 CREATION OF NEW EASEMENTS ON LAND BEING TRANSFERRED TO THE STATE	32
7.18.1 Creation Prior to Transfer.....	32
7.18.2 Creation Following the Transfer	32
7.19 DEEMED TRAMLINE EASEMENTS	32
8. LEASES.....	33
8.1 LEASES (L ACT).....	33
8.1.1 Sublease of a Lease or a Trust Lease of a Reserve.....	33
8.1.2 Leases over the Whole of the Land	33
8.2 LEASES (LT ACT)	33
8.2.1 Leases by Sketch Plan	33
8.2.2 Leases by Registered Plan	33
8.2.3 Leases over the Whole of the Land	33
8.2.4 Road Dedication over Leases	34
9. PLANS.....	35

9.1 GENERAL	35
9.2 REDRAWN PLANS	35
9.3 CANCELLING CLAUSES	35
9.4 DESCRIPTION	36
9.4.1 General	36
9.4.2 Locality	36
9.4.3 Easements	36
9.4.4 Resurveys	36
9.4.5 Old System Resurvey	36
9.5 ORIGINAL PORTIONS	36
9.6 PUBLIC USE LAND	37
9.7 ACCREDITED PLANS	37
9.7.1 Endorsement of Plans by an Accredited Surveyor	37
9.7.2 Alteration to Endorsed Plans Prior to Lodgement	38
9.7.3 Re-Endorsement	38
10. ROADS/RAILWAYS	39
10.1 GENERAL	39
10.2 ALIGNMENTS	39
10.2.1 Declared Alignments	39
10.2.2 Official Alignments	39
10.2.3 Notice of Realignment	39
10.3 NEW ROAD	39
10.3.1 Freehold Action Plan	39
10.3.2 State Land Action Plan	39
10.4 RESERVED ROADS AND ESPLANADES	40
10.5 ROAD CLOSURE	40
10.6 ROAD NAMES	40
10.7 ROAD RESERVATION	40
10.8 ROAD OPENING AND CLOSURE	41
10.9 ESPLANADES	41
10.10 RIGHTS OF WAY	41
10.11 RAILWAY BOUNDARIES	41
11. SURVEY	43
11.1 AREAS	43
11.1.1 Calculated Areas	43
11.1.2 Balance Areas	43
11.1.3 Three Line Areas	43
11.1.4 Part Lots	43
11.2 CLOSE LIMITS	43
11.3 COMPILED PLANS	44
11.3.1 Amalgamation by Compiled Plan	44
11.3.2 Subdivision by Compiled Plan	44
11.3.3 Compiled Plans for Resumptions Affecting Consolidated Titles	44
11.3.4 Compiled Plan of an Unsurveyed Parcel	44
11.4 CONFUSED BOUNDARIES	45
11.5 CURVED BOUNDARIES	45
11.6 DIMENSIONS	45
11.7 ENCROACHMENT	46
11.8 IDENTIFICATION SURVEYS	46
11.8.1 Placement of Additional Reference Marks on Subdivision Surveys	46
11.9 MERIDIAN	47
11.9.1 AMG Connections	47
11.10 NEW BOUNDARIES	47
11.11 PERMANENT MARKS	47
11.12 PROCLAIMED SURVEY AREAS	48
11.13 RESURVEYS	48
11.14 SURVEY RECORDS	49

11.15 UNDESCRIBED BALANCES - NEW UNDESCRIBED BALANCES ARE NOT PERMITTED	49
11.15.1 Development in Stages	49
11.15.2 Other Undescribed Balances	49
11.16 UNSURVEYED AND/OR CALCULATED BOUNDARIES	49
11.16.1 Opposite Side of Road Unsurveyed	49
11.16.2 Other Unsurveyed boundaries	50
11.17 VINCULA	50
11.18 PROFIT À PRENDRE	51
11.18.1 Specifications	51
12. HISTORICAL INFORMATION	51
12.1 COMMONWEALTH TITLES	51
12.1.1 Background	51
12.1.2 Previous Procedures	51
12.1.3 Current Procedures	51
12.2 HISTORICAL PLAN INFORMATION	52
12.2.1 Freehold Action Plans	53
12.2.2 Crown Action Plans	53
13. GLOSSARY OF TERMS	55
14. ABBREVIATIONS	62
14.1 GENERAL	62
14.2 CROWN TENURES — LAND ACT 1962	62
14.3 STATE TENURES — LAND ACT 1994	62
14.4 ACTS AND REGULATIONS & THEIR ABBREVIATIONS	63
15. REFERENCE PLANS	65
16. GENERAL:	89
16.1 CONTEXT OF REFERENCES	89
16.2 COMPLIANCE WITH OTHER LEGISLATION:	89
16.3 UNUSUAL CASES:	89
17. DEFINITIONS:	91
18. PLAN FORMS:	93
18.1 APPROVED FORMS:	93
18.2 MATERIAL SPECIFICATIONS FOR PLAN FORMS:	93
18.3 DIGITAL PLAN FORMS:	93
18.4 TRANSITION PROVISIONS FOR PLANS:	94
18.4.1 Plans for Community Titles Schemes:	94
18.4.2 Other Plans:	94
18.5 BUILDING UNITS AND GROUP TITLES ACT 1980 IN CONJUNCTION WITH SPECIFIED ACTS:	94
19. PLANS FOR REGISTRATION:	95
19.1 FORMS TO BE USED:	95
19.2 PLAN NUMBERING:	95
19.3 SHEET NUMBERING:	95
19.4 PLAN WITH ONLY ONE SHEET:	95
19.5 PLAN WITH ADDITIONAL SHEETS:	96
19.6 ADDITIONAL REQUIREMENTS FOR VOLUMETRIC FORMAT PLANS:	96
19.7 FORMAT TO BE NOTED:	96
19.8 LOTS TO BE DESCRIBED:	96
19.9 PLAN DESCRIPTION AND CANCELLING CLAUSE:	96
19.10 SURVEYORS CERTIFICATE:	97
19.11 NORTH POINT:	97
19.11.1 Protractor:	97
19.11.2 Protractor omitted:	97

19.11.3 Scales:.....	97
19.11.4 North may be rotated:.....	97
19.12 ALLOCATION TABLES:.....	97
19.13 NAME AND CMS OF COMMUNITY TITLES SCHEME:.....	98
19.14 PLANS MAY BE COMPILED:.....	98
19.15 VOLUMETRIC LOT AS ADJOINING INFORMATION:.....	98
19.16 AMENDMENTS TO PLANS:.....	98
19.16.1 After Lodgement, prior to registration:.....	98
19.16.2 After Registration:.....	98
20. SKETCH PLANS:.....	99
20.1 SKETCH PLANS PERMITTED:.....	99
20.2 STANDARDS:.....	99
20.2.1 All Sketch Plans:.....	99
20.2.2 Sketch Plans within a building:.....	100
20.2.3 Sketch Plans outside a building (part of the land):.....	100
20.2.4 Sketch Plans by Licensed Surveyor:.....	100
20.2.5 Sketch Plans by other than a Licensed Surveyor:.....	101
20.2.6 Leased Areas over multiple lots:.....	101
20.2.7 Multiple sheets:.....	101
20.2.8 Value:.....	101
20.2.9 Scales:.....	101
20.2.10 Scale Ratios:.....	102
21. EASEMENTS:.....	103
21.1 COMPLIANCE WITH LAND TITLE ACT:.....	103
21.2 FULLY DIMENSIONED:.....	103
21.3 EASEMENTS IN PARTS:.....	103
21.4 UNRESTRICTED EASEMENTS:.....	103
21.5 RESTRICTED EASEMENTS:.....	103
21.6 EASEMENT OCCUPYING THE WHOLE VERTICAL EXTENT OF A LOT:.....	103
21.7 EASEMENT AS ADJOINING INFORMATION:.....	103
22. PLAN FORMATS:.....	105
23. STANDARD FORMAT PLANS:.....	107
23.1 SUBDIVISION:.....	107
23.2 TO BE SURVEYED AND MARKED:.....	107
23.3 LOT NUMBERS:.....	107
23.4 PART LOTS:.....	107
23.4.1 Part lots separated by lots:.....	107
23.4.2 Other Cases:.....	107
23.5 LOTS OR LEASES WITH RESTRICTIONS IN HEIGHT AND OR DEPTH:.....	108
23.6 EASEMENTS WITH RESTRICTIONS IN HEIGHT OR DEPTH:.....	108
23.7 LOTS WITH EXISTING RESTRICTION "RELATIVE TO THE SURFACE OF THE LAND":.....	108
24. BUILDING FORMAT PLANS:.....	109
24.1 DEFINITIONS FOR BUILDING FORMAT PLANS:.....	109
24.2 SUBDIVISION:.....	109
24.3 LOTS ON A BUILDING FORMAT PLAN:.....	110
24.3.1 Creation of Building Format Lots:.....	110
24.3.2 Creation of a Standard Format Lot:.....	110
24.4 LOT NUMBERS:.....	110
24.5 PART LOTS:.....	110
24.6 DESCRIPTION OF PART LOTS:.....	111
24.7 BOUNDARY DEFINITION:.....	111
24.8 EXTERNAL BOUNDARIES:.....	111
24.9 LOCATION OF BUILDINGS:.....	111
24.10 INFORMATION TO GO ON THE MAIN PLAN:.....	112

24.11 MULTIPLE BUILDINGS:	112
24.12 MULTIPLE LEVELS:	112
24.13 LEVEL DIAGRAMS:.....	112
24.14 BUILDINGS WITH LEVELS OF DIFFERENT HORIZONTAL DIMENSIONS:.....	112
24.15 FLOORS WITH STEPS IN LEVEL:.....	112
24.16 PLANS WITH STANDARD AND VOLUMETRIC LOTS IN THE BASE PARCEL:	113
24.16.1 The provisions of this Direction may only be used:.....	113
24.16.2 Additional to Direction 24.8:.....	113
24.16.3 Lateral Aspect Diagram:	113
24.16.4 Level Diagrams:	113
24.16.5 Boundary between Standard and Volumetric lots:.....	113
24.17 BOUNDARIES OF LOTS:.....	113
24.18 BOUNDARIES OF LOTS NOT BOUNDED BY WALLS, FLOORS AND CEILINGS:	114
24.19 BALCONY:.....	114
24.20 CARPORT:	114
24.21 COURTYARD:	115
24.22 GARAGE:.....	115
24.23 PRIVATE YARD:	116
24.24 ROOFGARDEN:	116
24.25 VERANDAH:	117
24.26 OTHER CASES:	117
24.27 DIAGRAMS:	117
24.28 EASEMENTS:	117
24.29 ENCROACHMENTS:.....	118
24.29.1 Encroachment onto an adjoining lot or Unallocated State Land:.....	118
24.29.2 Encroachment onto road:	118
24.29.3 Maximum amount of encroachment:	119
24.29.4 Where a Volumetric lot is created to cover an encroachment:.....	119
24.29.5 Provisions of the Land Act:.....	119
24.29.6 Certificate on Encroachment:	119
24.30 PLANS OF AMALGAMATION OR SUBDIVISION OF LOTS:.....	119
25. VOLUMETRIC FORMAT PLANS:	121
25.1 SUBDIVISION:.....	121
25.2 GENERAL:	121
25.2.1 Creation of Volumetric Parcels:	121
25.2.2 Bounded in all dimensions:	121
25.2.3 Restricted or "In Strata" lots:	121
25.2.4 Subdivision of a Standard Format lot:.....	121
25.3 LOT NUMBERS:	122
25.4 PART LOTS:	122
25.5 VOLUMETRIC PARCELS:	122
25.5.1 To be fully Defined:.....	122
25.5.2 "To the Depth" not acceptable:	122
25.5.3 Area of footprint:.....	122
25.5.4 Volume:.....	123
25.6 VOLUMETRIC EASEMENTS:	123
25.7 VOLUMETRIC LEASES:	123
25.7.1 Leases on a Survey Plan:.....	123
25.7.2 Leases on a Sketch Plan:	123
25.8 DESCRIPTION OF VOLUMETRIC PARCELS:.....	123
25.9 MARKING OF VOLUMETRIC PARCELS:	123
25.10 DEFINITION OF VOLUMETRIC PARCELS:	124
25.10.1 Intersections and vertices to be defined:	124
25.10.2 Permanent Marks to be noted:.....	124
25.10.3 Polar Dimensions:	124
25.10.4 Rectangular Co-ordinates:.....	124
25.10.5 Parcel bounded by vertical planes:.....	124
25.10.6 Australia Height Datum unavailable:	125

25.11 REFERENCES TO WALLS AND FLOORS:.....	126
25.12 PLANS OF VOLUMETRIC PARCELS:	126
25.12.1 Isometric Diagram:.....	126
25.12.2 Dimensions to be shown:	126
25.12.3 Footprint of lot above or below the surface:	126
25.12.4 Footprint of lot intersecting the surface:	127
25.12.5 Ground levels on footprint:	127
25.12.6 Diagrams:	127
26. COMMON PROPERTY:	129
26.1 COMMUNITY MANAGEMENT STATEMENT REQUIRED:.....	129
26.2 DEFINED AS DIRECTED FOR FORMAT:	129
26.3 AREA:	129
26.4 FOOTPRINT IN A VOLUMETRIC FORMAT PLAN:.....	129
26.5 RE-DIMENSION NOT REQUIRED:.....	129
26.6 SUBDIVISION:.....	129
26.6.1 Common Property subdivided into lots:.....	129
26.6.2 Lots converted to Common Property:.....	130
26.7 EASEMENTS IN COMMON PROPERTY:.....	130
26.8 EXCLUSIVE USE AREAS:	130
27. TRANSFERRING LOTS INTO OR OUT OF A COMMUNITY TITLES SCHEME:.....	131
27.1 LOT TO BE ADDED TO COMMON PROPERTY:	131
27.2 LOT TO BE ADDED TO A COMMUNITY TITLE LOT:.....	131
27.3 PART OF COMMON PROPERTY TO BE EXCISED:	131
27.3.1 In the case of a Community Titles Scheme over a standard or volumetric format lot:	132
27.3.2 In the case of a Community Titles Scheme over a building format plan:	132
27.4 PART OF A LOT TO BE EXCISED:	132
27.5 AREAS OF COMMON PROPERTY:	133
28. STAGED SUBDIVISIONS:.....	135
28.1 METHOD 1:	135
28.2 METHOD 2:	135
28.3 METHOD 3:	135
28.4 METHOD 4:	135
28.5 METHOD 5:	135
29. RESERVATION OF A NAME FOR A COMMUNITY TITLES SCHEME:	137
30. TERMINATION:	137
31. MIXED USE DEVELOPMENT ACT:.....	139
31.1 DEFINITIONS FOR MUD ACT PLANS:.....	139
31.2 INTRODUCTION	139
31.3 PLAN FORMS TO BE USED WITH THE MUD ACT:.....	140
31.3.1 Modifications of form 21:	140
31.3.2 Modification of form 21A:.....	141
31.4 PLAN TYPES:.....	141
31.4.1 Community Plan:.....	142
31.4.2 Precinct Plan:.....	142
31.4.3 Stratum Plan:	142
31.4.4 Boundary Adjustment Plan:	143
31.4.5 Amendment Plans:	143
31.5 SUBDIVISION INTO BUILDING UNITS AND GROUP TITLES LOTS:	143
31.6 LOTS:	143
31.6.1 Lot Numbering:	143
31.6.2 Part Lots:	143
31.6.3 Lot Descriptions:.....	144
31.7 DESCRIPTIONS:.....	144

31.8 RESTRICTED LOTS:.....	144
31.9 EXTINGUISHMENT.....	145
31.10 MISCELLANEOUS.....	145
32. DIAGRAMS:.....	147
33. SPECIMEN PLANS:.....	147

TABLES

TABLE 1 LOT ALLOCATION.....	17
TABLE 2 LOT AND COMMON PROPERTY ALLOCATION.....	17
TABLE 3 PORTION ALLOCATION.....	18
TABLE 4 MORTGAGE ALLOCATION.....	18
TABLE 5 BENEFIT EASEMENT ALLOCATION.....	19
TABLE 6 ENCUMBRANCE EASEMENT ALLOCATION.....	19
TABLE 7 LEASE ALLOCATION.....	19
TABLE 8 PROFIT A` PRENDRE ALLOCATION.....	20
TABLE 9 CURRENT PLAN TYPES.....	35
TABLE 10 PLAN PROCESS STAGES.....	35
TABLE 11 ROUNDING DIMENSIONS FOR UNSURVEYED BOUNDARIES (COMPILED PLANS).....	45
TABLE 12 FREEHOLD ACTION PLAN TYPES.....	52
TABLE 13 MIXED USE DEVELOPMENT ACT PLAN TYPES.....	52
TABLE 14 CROWN ACTION PLAN TYPES.....	53
TABLE 15 PLAN TYPES THAT ARE COMMON TO BOTH FREEHOLD AND CROWN ACTION PLANS.....	53

REQUIREMENTS OF THE DEPARTMENT OF NATURAL RESOURCES

Authority for Requirements

Section 5 of the Surveyors Regulation 1992 empowers the Surveyors Board to issue Directions to Surveyors which are binding on them. The Board has issued Direction 1.0 requiring that lodgement of plans must conform with the requirements of Registering Authorities. This document itemises the mandatory requirements of the Department of Natural Resources and the legislative requirements of other Departments.

These have been derived from legislation, Land Title, Land Use and Land Boundaries Notifications, Registrar of Titles Directions for the Preparation of Plans, Departmental Policies and long standing professional practice. Where appropriate, the relevant legislation has been identified throughout the document.

This document has been prepared by officers of the Department of Natural Resources (DNR) and is to be used in conjunction with relevant Acts, Regulations, Directions and Policies issued by the Department of Natural Resources, the Surveyors Board of Queensland, and other Departments.

The requirements contained in this document, outline the majority of procedures necessary to ensure that survey plans deposited for registration are suitable for:

- ◆ the purpose of the survey;
- ◆ the proposed land dealing;
- ◆ the issue of resultant tenure documents;
- ◆ speedy data entry into the Department's strategic data bases.

The requirements specified in this document are mandatory unless qualified by one of the following identifiers:

- | | |
|--|---|
| ◆ general advice indicated by | A |
| ◆ information on DNR systems indicated by | S |
| ◆ background/historical information indicated by | H |

Notwithstanding anything contained in these requirements:

- ◆ The DNR reserves the right to reject any plan that is not correct for registration; and
- ◆ no responsibility is accepted by the DNR for any actions taken by persons external to the DNR pursuant to these requirements.

General

The copies of plans in Section E2 Survey Plan Guidelines are examples of actions necessitating lodgement of survey plans with the Department of Natural Resources.

The majority of the examples are copies of original plans held in the Department of Natural Resources, which have been suitably adapted to represent specific actions. As such these examples may not necessarily conform in every respect to all of the requirements stated in this manual. See Department of Natural Resources Specimen Plans Nos 1-3 Part E2 Survey Plan Guidelines.

The Senior Surveyor of a local Department of Natural Resources office should be contacted for inquiries concerning surveys that may not be included in the following examples. See Page iii for District Office addresses.

Update Process

This is a dynamic document that will change over time in response to changes in legislation, departmental policies and procedures and other factors that influence the surveying profession.

Proposed changes to the document should be referred to the Senior Surveyor of a local Department of Natural Resources office using a copy of the "Issues Sheet" (See following page).

Note: Hereinafter in this document a Senior Surveyor of a local DNR office will be referred to as "the local Senior Surveyor"

(Intentionally Blank)

1. GENERAL

1.1 Access Restriction Lots (Strips)

See also 11.15 Undescribed Balances (Page E3-49)

New lots for access restriction purposes may be the subject of a transfer to the relevant Local Government as trustees for Town Planning purposes. The only exceptions are where the land is owned by a Local Government within its own statutory area (See Section 8.1(2)(b) LG(P&E) Act), or where the State is the Registered Owner.

If part or all of an access restriction lot is to be dedicated as new road on a future plan, the area of the access restriction lot that is to be dedicated as new road must be included in the total area of new road and the description of the access restriction lot must appear in the cancelling clause. The plan must also be signed by the Local Government as registered owner/trustee. (LT Act)

The width of access restriction lots is determined by the relevant Local Laws of the Local Government.

If the land is taken for road purposes, to convert it to road requires either:

- a surrender to the State and subsequent gazettal as Road in terms of the Land Act 1994; or,
- registration of a plan showing the land as New Road.

Note: "Local Laws of the Local Government" were previously called "Local Government By-Laws".

1.2 Acquisition of Land

See also 1.3.1 Notice of Intention to Resume (NIR) (Page E3-7), 11.1.3 Three Line Areas (Page E3-43), and Policy PUX/900/013 Acquisition — Multiple Purposes.

This section deals with Acquisitions of Land under the AofL Act.

1.2.1 Freehold Land

Plans under the AofL Act:

- must deal only with the action being implemented by the resumption;
- must show all resumed areas as lots or easements, as appropriate;
- cannot dedicate new road;
- are registered under the provisions of the LT Act;
- must be signed by the resuming authority as Constructing Authority, and;
- do not require Local Government consent.

A

Encumbrances affecting land being resumed (but not including a resumption for easement purposes only) are automatically cancelled by Section 12(5) of the AofL Act, and must not be shown on the plan in the lot to be resumed.

The purposes for which land may be taken and by whom are set out in Section 5 of the AofL Act. Land acquired under the AofL Act may be taken for multiple purposes.

Where a subdivision of a balance parcel is required as part of a compensation agreement, the subdivision plan must follow the resumption plan. The subdivision plan is subject to the same requirements as any other plan of subdivision. Since the subdivision plan must follow the resumption plan, it will be necessary for it to show the resumed area with the status it will have when the resumption action is completed, e.g. Road.

1.2.2 Resumptions for Road and Transport Corridors

If land is taken by the Department for "road purposes and vested in the State", it becomes a road at the time of the initial proclamation. However, if land is taken by the Department for a

transport corridor, tenure issues in the name of the State of Queensland with Queensland Transport as the administering department. (TI(Road) Act)

The land that is to be taken by a resumption must be shown as a lot on the plan. A resumption document is required for recording the resumption in the register. (AofL Act) If the land is taken for road purposes, to convert it to road requires either:

- a surrender to the State and subsequent gazettal as Road in terms of the Land Act 1994; or,
- registration of a plan showing the land as New Road.

1.2.3 Resumptions for Other Authorities

See also 12.1 Commonwealth Titles (Page E3-51) and 2.6 Transfers to the State (Page E3-9)

If land is resumed by an Authority other than the State, the land vests in that Authority in fee simple. If the land is taken for road purposes, to convert it to road requires either:

- a surrender to the State and subsequent gazettal as Road in terms of the Land Act 1994; or,
- registration of a plan showing the land as New Road.

1.2.4 Resumptions from Non-freehold Land

The resumed land must be shown in a form that is consistent with the purpose for which the land is being resumed. That is, where the resumption is for road purposes the land being resumed should be shown as "Road" on the plan.

Resumptions for a Constructing Authority are subject to Section 5(3) of the AofL Act and must be resumed for a specified purpose.

1.3 Administrative Advices

S An Administrative Advice is a noting, placed on a file attached to the Register, of a present or future action or condition, affecting the subject title, to alert interested parties searching the Register, of such action or condition. The administrative advice is usually authorised by statute, but is not a registrable estate or interest in, or charge on the subject land.

S The objective of administrative advices is to provide the mechanism to alert registered owners and other interested parties to the existence of matters affecting land under the provisions of:

- ◆ Queensland legislation including:
 - The Acquisition of Land Act;
 - The Contaminated Land Act;
 - The Land Title Act;
 - The Land Act and
 - The Queensland Building Service Authority Act;
- ◆ Other determinations by Government.
- ◆ Other determinations by interested parties.

S While these Advices do not encumber the title of the land they may prevent the registration of a dealing.

S Interested parties are to be alerted to any advice of an administrative nature by a noting in the register.

S Where a Certificate of Title is found to be in error due to incorrect survey information, the Registrar may enter an Administrative Advice over the title and notify the registered owner that a survey plan will be required to register future dealings.

S Further information relating to these advices should be obtained from the relevant authority.

1.3.1 Notice of Intention to Resume (NIR)

See also 1.2 Acquisition of Land (Page E3-5)

Plans that deal with land affected by an NIR and purport to effect the resumption must be noted with "NIR satisfied" (or "NIR satisfied in respect of Lot/s x etc".) This is required to ensure that the notice is cancelled for the lot/s that are no longer affected.

- A Refer to Sections 7(4)(a) and 7(4)(b) of the Acquisition of Land Act.
- A An ATS search will reveal any Notices of Intention to Resume recorded in the Land Registry.
- A Notices of Intention to Resume lapse if the application to the appropriate Minister to take the land has not been made within twelve months of issue of Notice of Intention to Resume or, in the case of the Brisbane City Council if the Notification of Resumption has not been published in the Gazette within twelve months after the date of the Notice of Intention to Resume (AofL Act Sec 16(2) Sec 9(3)). The Notice of Intention to Resume is removed from the title by the authority that registered such notice.

Note: There is no mechanism in place to verify that an NIR has lapsed. The NIR will remain as an Advice on the Title until action is taken to remove it by the person or authority who caused the NIR to be recorded.

1.4 Adverse Possession

Adverse possession cannot be claimed against State Land. (Section 6(4) Limitation of Actions Act 1974)

For adverse possession of freehold land see Part 6 Division 5 of the LT Act.

A Right of Way may be subject to an application for Adverse Possession.

1.5 Reservations in Title

See also 10.7 Road Reservation (Page E3-40) and Policy PUX/901/111 Reservation in Title — Sale of Unrequired Reservation.

When a lot that is the subject to a reservation in title is subdivided, the reservation must be dealt with by:

- ◆ purchase of the reservation by the registered owner without competition; or
- ◆ allocation of the reservation to one or more of the subdivision lots. (L Act)

In both of the above cases an application must be lodged with a District Office of the DNR. However, it is Departmental policy to extinguish unwanted reservations wherever possible.

- A Since lots that are subject to reservations in title must have action taken to deal with the reservation, early application should be made to the DNR so that the necessary formalities can be completed without unduly delaying the registration of the survey plan. Reservations may be allocated using the subdivisional design plan. In most cases the DNR will prefer the applicant to purchase the reservation.

The Department will advise the applicant of its requirements in relation to the allocation of the reservation and the form of the allocation certificate that must appear on the plan. The allocation certificate must be signed by the DNR delegate prior to the lodgement of the plan with the Registrar of Titles.

1.6 River Improvement Trust

- A For an example of a plan subject to the River Improvement Trust See RP167212 and Lot 2 on RP116442. Title 15515100.

1.7 Unusual Cases

- A For instances of unusual cases refer to the following plans:

- ◆ Centre of creek as boundary — see RP153117.
- ◆ Balance area for easement — see RP201663
- ◆ Balances suburban lot — see RP208685.
- ◆ Area by indirect means — see RP203179.

2. ADMINISTRATIVE

2.1 Administrative Boundaries - County, Parish and Local Government

Administrative boundaries require gazettal for any change to their location. If an administrative boundary coincides with a lot boundary, the location of which is subsequently changed, the administrative boundary does not change and must therefore retain its original location.

2.2 Amalgamations

Following the amendment to Section 50.(g) of the LT Act Local Government consent to plans of amalgamation is no longer required. Where the Local Government requires new road, Access Restriction Lots, etc as part of a development approval, a copy of the letter from the LG must be lodged with the plan.

Local Government approval and a new survey plan is required to re-create lots that were previously amalgamated by survey. (LG(P&E) Act)

- A** Where parcels have previously been amalgamated they may be re-created by a compiled plan. See Section 25 of the Surveyors Regulation, provided that the monuments indicating the separate lots have not been removed.

2.3 Titles Comprising Multiple Lots

2.3.1 Consolidated Titles

See also 11.3.3 Compiled Plans for Resumptions Affecting Consolidated Titles (Page E3-44)

Where a lot/lots that is/are contained within a consolidated title is/are adjusted using Section 358 of the L Act only, the dimensions and area of the affected lot/lots only is/are required to be shown on a plan. The plan must bear a statement of the Total Deed area of the consolidated title as well as a list of the lots contained within the consolidated title. This information is required for the preparation of the Deed of Grant.

EXAMPLE:

<p>TOTAL DEED AREA 144.2523 Lots 1 & 2 on RP432167 and Lots 5 - 7 on SL32114</p>

- A** A single Title for two or more lots that have the same registered owner may be created under Section 39 of the LT Act if the Registrar so permits.

- A** Separate Titles may be issued for each of the lots in an existing single Title if:
- ◆ the description in the existing single Title indicates that there is more than one Lot;
 - ◆ each of the lots is described on either a freehold or State Land Action Plan and each lot is fully dimensioned and has an area; and
 - ◆ if there is no conditional consent noted on the plan or plans of the lots to the contrary.

Note: Where Workers Homes Perpetual Town Leases and State Housing Perpetual Town Leases were freeholded, it is not uncommon to find that the description in the Deed of Grant consists of two separate lots that are separate identities on an original Registered Plan. It is also noted in the Deed of Grant that it was granted under the Workers Homes Corporation Act or the State Housing Act. Whether or not separate titles may issue is a matter for determination by the Registrar.

2.3.1.1 Conditional Consent

- A** Separate Titles may not be issued from an existing single Title if the plan on which the lots were created is the subject of a conditional consent from the Local Government, which requires that the lots under investigation be "amalgamated" "consolidated", "held in one title" or other similar wording.
- A** In this case, separate titles may be issued if the appropriate Local Government grants approval to removal of the conditional consent and submits this decision in writing to the Registrar of Titles.

2.3.1.2 Section 358 (L Act) Actions

- A** Section 358 of the L Act actions, are those where an owner of freehold land surrenders his land to the State to enable the addition or excision of land, or to have boundary dimensions corrected. The land is restored to him by way of a deed of grant, which must leave him in the same position as he was prior to the surrender, other than for the amendments that necessitated the action.

A Section 358 action is implemented on a State Land Action Plan, which must:

- ◆ show the boundaries of the lot in their final amended form;
- ◆ show appropriate action statements; and
- ◆ show all the encumbrances which affected the original lot, unless these were surrendered prior to the surrender of the freehold title;

Proposed easements may be shown on this plan for the purpose of reinstating an existing easement. The easement is created by the registration of an instrument lodged to follow the issue of the deed of grant. That is, they are created by registration of the instrument under the LT Act, and not the L Act. A copy of the State Land Action Plan must be attached to the instrument of easement when it is lodged.

2.3.2 Amalgamated Titles

- A** Amalgamated Titles are those in which multiple parcels of land are compulsorily held in one title by virtue of a condition in a Local Government consent to a plan.
- The parcels must remain in the same title until the condition is waived or varied by the Local Government by way of a letter to the Registrar.
- A** Amalgamated titles have been replaced by plans of amalgamation or by Registered Agreements under Section 4.17 & 5.8(3) of the LG(P&E) Act.

2.4 Border Surveys

See also Policy PBO/900/004 Surveys in Areas Adjacent to State Borders.

All surveys in areas adjoining State borders shall be undertaken in collaboration with the organisation responsible for surveying in the adjoining State.

- A** Where a survey is adjacent to a State border the local Senior Surveyor should be contacted for advice and coordination of the survey activity with the adjoining jurisdiction.

2.5 Rejected Plans

The Registrar may reject a lodged plan under Section 142 of the LT Act. A rejected plan may be relogged but will be regarded as a new plan in all respects.

2.6 Transfers to the State

See also 9.6 Public Use Land (Page E3-37), Land Use Policy PUX/900/001B and Land Use Notification PUX/952/018

Land being transferred to the State for public use must be clearly identified on the face of the plan in accordance with Section 50 of the LT Act. Land transferred to the State for a public or

community purpose must conform with those purposes shown in Schedule 1 of the L Act. The method of presentation is as follows:

<p>"Lot 1 Public Use Land (Park)"</p>	OR	<p>"Lot 1 (Park)" (if there is insufficient space within the lot.)</p>
---	----	--

Land may be transferred to the State:

- ◆ as a normal transfer following a plan of subdivision; or
- ◆ by noting land on a plan of subdivision in accordance with Section 50(a) of the LT Act, when it is transferred to the State on registration of the plan without the lodgement of any further instrument.

A parcel being dedicated for public use on registration of a plan may only be noted on the face of the plan with one the following:

- ◆ ROAD. (It is acceptable to indicate New Road).
- ◆ Lot number and "PARK".
- ◆ Lot number and "RESERVE".
- ◆ Lot number and "PUBLIC USE LAND".

Other than Public Utility easements, which may be carried forward with the prior consent of the Minister, all existing encumbrances must be surrendered to precede the plan. (See also 7.18 Creation of New Easements on Land being Transferred to the State (Page E3-32), for public utility easements that may be required to be created following the transfer)

Once the land has been transferred to the State, future surveys affecting that land may only be effected by the lodgement of an appropriate State Land Action Plan. (L Act)

2.7 Withdrawal and Re-lodgement of Plans

To ensure that a plan is registered in the correct sequence such that the plan and associated documentation will give effect to the intention expressed, the Registrar under Section 144 of the LT Act:

- ◆ may withdraw the instrument (i.e. plan) and re-lodge the instrument to follow the lodgement of some other instrument; or
- ◆ may, if it is an instrument that should not have been lodged, permit the instrument to be withdrawn and on receiving a written application, the Registrar may re-lodge the instrument.

Withdrawal and relodgement of a plan does not affect the period of validity for Local Government consent, the date for which remains at the date of original lodgement.

2.8 Withdrawn Plans

Plans may be withdrawn from the registration process on request. The request must be in writing by the lodger or registered owner (under seal if a company).

A copy of the plan is imaged and the original returned to the lodger.

A withdrawn plan may be relodged for registration. When a withdrawn plan is relodged, it is regarded as a new plan in all respects.

3. Consents

3.1 Department of Environment

Subdivisions in Coastal Management Control Districts and Erosion Prone Zones require the consent of the Department of Environment.

3.1.1 Beach Protection Authority

See Section 45 BP Act

Where a subdivision or the opening of a road is wholly or partially within a Coastal Management Control District (CMCD), the approval of the Beach Protection Authority (BPA) is required after the Local Government consent. In a CMCD, the Registrar must not record a plan of subdivision without the plan bearing a certificate by the Secretary, Beach Protection Authority stating the necessary consent has been given by the Governor-in-Council.

In a CMCD, the Local Government approval to subdivide has no force or effect in law WITHOUT the subsequent consent of the Governor-in-Council. If consent is refused any approval by a Local Government is void. There is no time limit on the approval nor are there any area limits.

For the purposes of Section 45 of the BP Act, a CMCD also includes land to which an Erosion Prone Area Plan applies. In general terms Erosion Prone Area Plans exist over all tidal waters of Queensland, and, by their definition, have an effect on the adjacent land.

3.2 Department of Natural Resources

3.2.1 State Land Actions

See State Land Notification PUX/952/057 Registration of Plans for Dealings in Terms of the Land Act 1994

A Not all plans of non-freehold land are State Land Action plans. These plans fall into two basic categories, those for which the Department is merely a depositary and those which fall under the provisions of the Land Act 1994, which the Department administers.

Plans for which the Department is simply a depositary include plans prepared under the Harbours Act, Customs Proclaimed Areas, Port of Brisbane Leases, etc.

Actions such as road closures, subdivision of, easements in, or other actions on, State leasehold land or any other plan dealing with State Land are dealt with under the provisions of the Land Act 1994. Plans in this category all require the consent of the Minister, and are then subsequently lodged with the Registrar of Titles for completion of the necessary action.

Note: Plans for easements over leases, subleases of leases or trustee leases of reserves will be returned to the lodging party for lodgement into the Land Registry together with the executed easement, sublease or trustee lease documents.

3.2.2 Barrier Fences

A Under Section 180 of the RLP Act the Minister may issue an order for the establishment and maintenance of barrier fences. Section 202 provides for the establishment of a ring fence by an Order in Council. These orders are endorsed on the title to which they relate.

A For an order under the BF Act See RP165728.

Note: The BF Act has been repealed by the RLP Act.

A In general orders under the RLP Act are no longer enforced since the DNR or the local government undertake the maintenance of these fences.

When lots which are subject to an order under the RLP Act are subdivided, the plan of subdivision shall be submitted to the local District Office of the Department of Natural Resources. The District Office will refer the plan to the relevant section of the Department to enable certification by the Minister's delegate that all of the new lots are no longer subject to the order. This eliminates propagation of orders which are no longer enforced.

3.2.3 Catchment Areas

Lots in Proclaimed Catchment Areas with areas under 16ha. require the approval of the Director General, Department of Natural Resources (Director General, DNR) prior to the Local Government consent. (WR Act)

- A** The approval of the Director General, DNR remains in force for six months.

3.2.4 Channel/Drain Areas

See also 2.6 Transfers to the State (Page E3-10)

Channel and drain areas must be given lot numbers and the words "(CHANNEL AREA/DRAIN AREA)" shown in brackets on the face of the plan but not in the description.

Unless the plan is signed by the Director General, DNR or his delegate as registered owner, the plan must be endorsed by the Director General, DNR to precede Local Government consent and a transfer to the State must be lodged. There is no time limit on the approval of the Director General, DNR.

On subsequent plans, the channel/drain area must be described with the Lot/Plan description and "(CHANNEL/DRAINAGE AREA)" must be shown in brackets on the face of the plan.

- A** Vincula are allowed across channel areas.
- A** A channel or drain area, adjoining a road does not deny legal access to the road under Sections 127(7) & 128(3) of the WR Act. However, the channel or drain area in itself does not constitute legal access to a lot that is remote from a road or other legal access.

3.2.5 Forest Entitlement Areas

See also Policy PUX/901/340 Tenure Creation — Access to Forest Entitlement Areas (FEA)

- H** Forest Entitlement Areas (FEAs) were first introduced into the Land Act 1962 in 1974. FEAs applied to leases under the Land Act that could be converted to a freeholding tenure such as GHPLs and GHFLs. (See Glossary of Terms for a definition of Forestry Entitlement Areas)

When first introduced the leases were issued over the gross area of the lease without any adjustment for the FEA reservation. This occurred since in most cases there were no surveyed dimensions available for the FEA and areas were not known with any degree of certainty.

While FEAs appear on plans held by the DNR and show calculated areas they are not cadastral surveys in terms of the S Act. In general FEAs were surveyed by surveyors of the Department of Primary Industries who are not endorsed to perform cadastral surveys.

- A** Since an FEA is a reservation in title no dedicated access to the FEA is required.
- State Leases that are subject to an FEA must show the FEA as a reservation in title. If the FEA is surveyed, the extent of the FEA must be shown on the face of the plan in hairline. The area of the lot must show a multiple line with an exclusion for the FEA.

3.2.6 Irrigation Areas

A Local Government may not approve a plan of subdivision in an Irrigation Area unless the plan has first been approved by notation thereon by the Director General, DNR.

The approval of the Local Government must be applied for not later than twelve months after the date of notation by the Director General, DNR. Schedule Part 1 Clause 31A.(7) of the WR Act.

A plan by a Constructing Authority is not a subdivision for the purposes of Section 31.A of the WR Act and does not require the approval of the Director General, DNR.

3.3 Local Government

3.3.1 Local Government Boundary

See also Part E2 Survey Plan Guidelines Example Plan No 6

If land represented on a plan falls within more than one Local Government, the consent of each Local Government is required. If a lot is within more than one local government, an allocation of that part of the area within each Local Government must be shown on the face of the plan.

3.3.2 Agreements — LG(P&E) Act

3.3.2.1 General

The LG(P&E) Act allows agreements to be registered between the Local Government and the registered owner to the effect that parcels of land separated by a transport corridor, river or creek must be held in the same ownership.

When a plan of subdivision has been approved by a Local Government with a condition that certain specified Lots must not be disposed of separately, registration of the plan and the Agreement must be made concurrently.

3.3.2.2 Land Under Same Use—Section 4.17 LG(P&E) Act

Section 4.17 of the LG(P&E) Act deals with land to be held conjointly because the two parcels of land are to be used for the same purpose. e.g. a hotel and car park separated by road. The parcels may be on separate plans, but must be within 500 metres.

3.3.2.3 Land Under Minimum Area—Section 5.8(3)(c) LG(P&E) Act

See also 11.17 Vincula (Page E3-50)

Section 5.8(3)(c) of the LG(P&E) Act deals with land to be held conjointly because one parcel of land is below the minimum area allowed by the Local Government. The parcels must be on the one plan and adjacent across a transport corridor or watercourse. (Surveyors should note that as vincula are now permitted, it would be preferable to use vincula instead of an Agreement if the Local Government so consents)

3.3.2.4 Cancellation of Agreements

Agreements are cancelled by a Request to Cancel Agreement (Form 14).

Where land affected by an Agreement is subdivided, the Agreement must be fully or partially cancelled by a Request to Cancel Agreement (Form 14).

A Consent by the Local Government on a Form 18 must be attached to the "Request To Cancel" the agreement.

3.3.3 Local Government Conditional Consent

A Local Government consent may be conditional. An example of a conditional consent is: "Subject to the registration of an application to register an agreement in accordance with Section....(insert appropriate section)....of the LG(P&E) Act and subject to Lots being held in the same ownership."

The only conditions allowed are those which are capable of being implemented by the DNR in conjunction with that survey. Consequently a conditional consent on one plan cannot apply a condition to a lot on another plan.

The following is provided to surveyors for information only and is not intended to be a definitive reference for Local Government Consent conditions.

In the past there has been some concern regarding the legality of some conditions that were included by Local Governments in their consent to survey plans. The following is a brief resume of what cannot be included in a conditional consent and what conditions are unnecessary to include in the consent:

Prohibited conditions include:-

- Transfer of ANY land to the Local Government, either as Trustee or in fee simple. This includes transfers of any access restriction strips that might be necessary. If the Local Government requires these transfers, they must be lodged with the plan.
- Any condition that cannot be enforced by the Department in the normal course of processing the plan.

Unnecessary conditions include:-

- Registration of easements on a subdivision plan. Since these are processed under Subdivision B of Part 4 of the Land Title Act, the plan may not register until the easement documents are capable of simultaneous registration.
- "Transfer", "Dedication", or any other such term, of Public Use Land shown on the plan. This is an automatic action once a plan showing Public Use Land is registered, and no additional documents are needed to effect the transfer to the State.

3.3.4 Local Government Consent

See also 7.13 Local Government Consent (Page E3-31)

Local Government Consent is required for all subdivisions and plans of amalgamation of freehold land whether by compilation or survey except:

- ◆ Resumptions;
- ◆ Plans lodged for and on behalf of the State Section 5.3.12 LG(P&E) Act;
- ◆ Subdivisions under the PL Act Part XI Section 185 (1)(b). Order of Supreme Court for relief in respect of encroachment;
- ◆ Easement Plans;
- ◆ Plans of resurvey only; and
- ◆ Actions by the Port of Brisbane Corporation.

Some Local Governments have interpreted Section 5.3.(1A) of the LG(P&E) Act as meaning they are not required to seal plans submitted under this Sub-Section. However, a copy of the letter giving the development consent, and noting the requirement of the plan as one of the conditions, will be acceptable in lieu of the Local Government consent, with the provision that it is obvious that the plan is not the result of an application under Section 5.1. of the LG(P&E) Act.

Plans must be lodged within 6 months of Local Government consent or a fresh consent obtained. Section 5.3.6 and Section 7,8 & 9 of the LG(P&E) Act

Where a Local Government has consented to an Easement plan and the consent has lapsed, it must be resealed or the original consent deleted by the Local Government.

Plans of amalgamation outside the Brisbane City Council lodged prior to 25th May 1985 did not require Local Government consent.

Note: Easements which provide access to a public road require Local Government approval to be deposited with the instrument of easement.

Note: Withdrawal and relodgement under Section 53 and 144(6) of the LT Act does not affect the lodgement date for Local Government consent.

3.3.5 Existing Conditions of Amalgamation

Amalgamation conditions in a Local Government consent must be waived or varied when one of the parcels involved is being subdivided. A letter from the Local Government should be forwarded to the DNR or the survey must satisfy the condition.

3.3.6 Minimum Areas

Where there is no planning scheme in force over land being subdivided, the minimum area permitted by the LG(P&E) Act is 400m², unless a lot with less than that area is "to be transferred to the Local Government or to the State or is to be used for public utilities." (Section 5(8)(2)) of the LG(P&E) Act

3.4 Canals

3.4.1.1 General

Canals are given lot numbers and the word "(CANAL)", in brackets, is shown on the face of the plan but not in the description.

On subsequent plans, canals are described with the Lot/Plan description and the word "(CANAL)" is shown in brackets on the face of the plan.

3.4.1.2 Freehold Land

See also 2.6 Transfers to the State (Page E3-10)

Under Section 9(d) of the Canal Act, canals can only be created by a Freehold Action plan which is endorsed with the details of the relevant Executive Minute. The date that the Clerk of the Executive Council signs the plan must follow the date of the Local Government consent. There is no time limit on the Executive Minute.

A The canal must be transferred to the State. Registration of the plan will be delayed until the transfer to the State is also capable of registration.

If encumbrances exist, these must be surrendered before the transfer to the State.

3.4.1.3 State Land

For canals created on State Land Development Leases, show the word "CANAL" as appropriate.

(Intentionally Blank)

4. ALLOCATIONS

4.1 Lot Allocations

Where there is more than one original lot cancelled by a plan the new lots, easements and/or new roads on that plan of survey must be allocated to the underlying original lots that this plan is cancelling.

The allocation table is created by extending the Title Reference table. The Title Reference is shown in its column on the back of the plan as normal, under the "Title Reference" heading. The lot description of the land being dealt with on the plan is shown under the "Description" heading. If there is more than one lot in the title, also being dealt with on the plan, this is set out in column form, again under "Description".

A column should then be created for any or all of Lots, Road or Easements as required for a particular plan. Lots, New Road and/or Easements being created on the new plan are then listed in these column/columns on the line of the original lot it derives from. It is acceptable to have a series of new lots, i.e. 1-10, together with a single original lot.

Note: A new lot may be linked to more than one original lot.

EXAMPLE:

Title Reference	Description	New Lots	Road	Emts
12349083	Lot 1 on RP123987	1 - 3	New Rd	A, B
	Lot 5 on RP813965	3 - 5	New Rd	A, B
	Lot 6 on RP813965	4 - 7		
18672223	Lot 2 on RP230965	5, 6		C
15692213	Lot 1 on SL2398	4 - 8	New Rd	
	Lot 5 on RP873943	8		
17693211	Lot 999 on RP829123		New Rd	

Table 1 Lot Allocation

EXAMPLE:

Involving Easements in Common Property (created on different plans) within a Community Titles Scheme

Title Reference	Description	New Lots	Road	Emts
12349083	Lot 1 on RP123987	1 - 3	New Rd	A, B
	Lot 5 on RP813965	3 - 5	New Rd	A, B
	Lot 6 on RP813965	4 - 7		
18672223	Lot 2 on RP230965	5, 6		C
15692213	Lot 1 on SL2398	4 - 8	New Rd	
	Lot 5 on RP873943	8		
17693211	Lot 999 on RP829123		New Rd	
18945367	CP on SP123456			A,C
	CP on SP154329			B

Table 2 Lot and Common Property Allocation

4.2 Portion Allocations

See also 9.5 Original Portions (Page E3-36)

Where there is more than one new lot on a plan AND more than one original Portion being affected by the survey, an allocation must be made of each new lot (only) into each portion. If there is more than one parish, the parish must also be noted against the Portion number.

The allocation of new lots to original portions should be based on the original portions shown in ATS. That is, there is generally no requirement for the surveyor to search any further than ATS in preparing the allocation table.

Note: Original Grant references are not required to be shown on the plan.

Where the lot or lots of a new survey affects more than one original Portion, the original portion boundaries must be accurately plotted on the plan in a black ink as broken hairline line where they are not coincidental with a boundary. The original Portion numbers shall be noted in a fine dotted style in ink.

As portion allocations are only required for allocation to new lots, it is not necessary to show original portions on the face of an easement plan, or to allocate new easements to portions. However, the original portion should still be noted on the Original Portion line.

Note: Where the original portion number contains an alpha character, such as 98A, and the number has been converted (i.e. the number has been converted to another number that does not contain an alpha character), the portion number to be used is the original number, not the converted number.

The format for the allocation table is:

PORTION ALLOCATION		
LOTS	ORIG POR	PARISH
1	36, 80	(Only if necessary)
2	36, 80	
100	36, 80	

Table 3 Portion Allocation

Note: Title and Portion allocation tables must not be combined.

4.3 Existing Mortgage Allocations

Where a mortgage affects part only of the land being subdivided, it is necessary to note which new lots are fully or partially encumbered by that mortgage so that the mortgage can be carried forward on to the new titles.

A table similar to the one below is required to allocate these encumbrances:

Mortgage	Lots Fully Encumbered	Lots Partially Encumbered
<Dealing No>	1 - 4 & 9 - 11	5 - 8

Table 4 Mortgage Allocation

Note: The dealing number for the mortgage to be allocated is available from the title reference of the lot being cancelled. The Dealing Number is used as the reference in preference to a "lot on plan" description (e.g. Lot 2 on RP432567) since an individual lot may have a number of different mortgages registered over the lot. The unique identifier for the interest being allocated is the Dealing Number.

4.4 Existing Easement Allocations

Existing easements within lots, i.e.. encumbrance easements, are required to be allocated to new lots. There are occasions where easements, external to lots provide benefit to a lot or part of a lot, i.e.. benefit easements. In order to carry the benefit forward to the new titles the benefit needs to be allocated to the benefited lots. The following section provides information for the preparation of the relevant allocation table.

4.4.1 Benefit Easements

Where a registered benefit easement benefits part only of a lot being subdivided, it is necessary to note which new lots are fully or partially benefited by the easement, so that the benefit can be carried forward on to the new titles.

A table similar to the one below is required to allocate these benefit easements:

Easement	Lots Fully Benefited	Lots Partially Benefited
<Dealing No>	1 - 4 & 9 11	5 - 8

Table 5 Benefit Easement Allocation

4.4.2 Encumbrance Easements

Where a registered encumbrance easement exists over a lot being subdivided into more than one new lot, the new lots shall be noted with the encumbrance in the following manner:

Easement	Lots to be Encumbered
<Dealing No>	1 - 4 & 9 - 11

Table 6 Encumbrance Easement Allocation

Before making this allocation, surveyors must ensure that:

- ◆ the easement is registered; and
- ◆ the easement is not to be surrendered to precede the lodgement of the plan.

Note: The dealing number for the benefit or encumbrance easement to be allocated is available from the title reference of the lot being cancelled. The Dealing Number is used as the reference in preference to the "lot on plan" description (e.g. Emt A in Lot 2 on RP432567) since an individual easement description may have a number of different easements registered over the same physical space. The unique identifier for the interest being allocated is the Dealing Number.

4.4.3 Existing Leases (LT Act)

Where a registered lease exists over a lot being subdivided into more than one new lot, the new lots shall be noted with the encumbrance in the following manner:

Lease	Lots to be Encumbered
<Dealing No>	1 - 4 & 9 - 11

Table 7 Lease Allocation

Before making this allocation, surveyors must ensure that:

- ◆ the lease is registered; and
- ◆ the lease is not to be surrendered to precede the lodgement of the plan.

Note: The dealing number for the lease to be allocated is available from the title reference of the lot being cancelled. The Dealing Number is used as the reference in preference to the "lot on plan" description (e.g. Lease A in Lot 2 on RP432567). The unique identifier for the interest being allocated is the Dealing Number.

4.5 Existing Profit a` Prendre

Where a Profit a` Prendre affects part only of the land being subdivided, it is necessary to note which new lots are fully or partially encumbered by that Profit a` Prendre so that the Profit a` Prendre can be carried forward on to the new titles.

A table similar to the one below is required to allocate these encumbrances:

Profit a` Prendre	Lots Fully Encumbered	Lots Partially Encumbered
<Dealing No>	1 - 4 & 9 - 11	5 - 8

Table 8 Profit a` Prendre Allocation

Note: The dealing number for the Profit a` Prendre to be allocated is available from the title reference of the lot being cancelled. The Dealing Number is used as the reference in preference to a "lot on plan" description (e.g. Lot 2 on RP432567) since an individual lot may have a number of different mortgages registered over the lot. The unique identifier for the interest being allocated is the Dealing Number.

5. CORRECTIONS TO PLANS

5.1 General

Where an amendment certificate is required to be shown on the plan it must be in the following form:

EXAMPLE:

Amendments by me (Natural Person) or (Body Corporate)..... (Date)

Licensed Surveyor (and Director)

Where the surveyor is a body corporate the amendment certificate must be signed by a licensed surveyor who is a director, in which case the certificate must specify "Licensed Surveyor and Director". The company seal is not required.

Amendments to the surveyor's certificate (e.g. Form 13) are covered by the amendment certificate. No part of the surveyor's certificate may be deleted. If necessary a new surveyor's certificate should be shown on the face of the plan immediately above the original certificate. If space does not permit the new certificate may be shown on the back of the plan.

5.2 Original Plans Prior to Lodgement

Original plans may be corrected by erasure and addition without the need for an amendment certificate.

5.3 After Lodgement but Prior to Registration

Following lodgement but prior to the plan being registered alterations and additions must be in black ink and must be effected by strike out and addition.

A certificate of amendment must be shown on the plan and signed by the surveyor in black ink.

5.4 After Registration

Following registration of the plan, any correction, either by alteration or addition must be in colour other than black ink that is suitable for reproduction through scanning and photocopying processes. Corrections to Registered Plans are effected under the provisions of Section 15 of the Land Title Act 1994 and Section 291 of the Land Act 1994. Corrections can only be effected by an officer of the DNR with a delegation to make such corrections.

Corrections can only be made following the lodgement of a Form 14 General Request dealing requesting such corrections, and must be accompanied by a Statutory Declaration from the surveyor as to the correction to be made.

Where a correction affected the metes, bounds, area or description of a parcel a fee, in accordance with the relevant fee schedule, must accompany the Form 14. Corrections to other information on the plan, in general, may not be subject to a fee. Where a surveyor believes that a fee should not apply an application must be made for the waiving of such fees. This application must be accompanied the Statutory Declaration, etc. If the Department determines that a fee is not applicable a "Departmental Dealing" will be prepared for registration of the correction. However, if a fee is required the surveyor must prepare a Form 14 to accompany the dealing.

Requests for corrections should be forwarded to the relevant Senior Surveyor in one of the Department's District Offices or Survey Infrastructure Services Landcentre Woolloongabba. Arrangements will then be made for the correction of the plan and registration of the documents.

Where the error affects the parcel in either dimensions, area or description the following documents must accompany the Form 14 :-

- (Monuments not affected) The consent of the registered owner and registered proprietor of the affected lot to the correction;
- (Monuments affected) The consent of the registered owner and registered proprietor of the affected parcel and any adjoining registered owner who is affected by the correction.

Note: Statutory Declarations can only be made by natural persons. A body corporate or company cannot make such declarations.

The Form 14 must be completed by the surveyor who signed the plan. Unlike the Statutory Declaration this form must be completed by Bodies Corporate where they were the surveyor. In these instances Items 5 and 7 of the form must agree. If a Body Corporate is identified in Item 5 the Form must be signed by the Directors at Item 7.

After the completion of the correction process the surveyor will be sent a copy of the plan as part the normal distribution process.

5.5 Building Unit and Group Title Plans

All amendments to plans under the BUGT Act 1980 both before and after lodgement must be made by crossing out and amendment in black ink and an amendment certificate is required.

5.6 Identification Plans

All amendments to identification survey plans that have been deposited with the DNR must be effected by strikeout and addition. Such alterations must be accompanied by an amendment certificate. The plan will then be re-imaged.

5.7 Surveyor's Book

See also 11.8.1 Placement of Additional Reference Marks on (Page E3-46)

Surveyor's Book corrections are no longer permitted.

H The Surveyor's Book was a system that allowed for plans to proceed to registration even though minor amendments or addition of reference mark information were required to be made to the plan.

5.8 Patent Error

Patent error corrections may only occur prior to the registration of a plan lodged for registration under the LT Act.

Patent error corrections may be used for:

- ◆ information which is patently incorrect or incomplete;
- ◆ compiled original information;
- ◆ balance areas.

Patent error corrections cannot be used for:

- ◆ survey information which affects the reinstatement of original boundaries;
- ◆ survey information for new lots;
- ◆ calculated areas.

5.9 Requisitions

Where errors are detected on a plan, a requisition may be issued to the lodger for forwarding to the surveyor.

Surveyors may appeal against any Requisition, firstly, to the local Senior Surveyor. If agreement regarding the requisition cannot be reached, Section 23 of the Surveyors Regulations 1992 may apply.

Pursuant to Section 76A (4) of the S Act a Licensed Surveyor may authorise another Licensed Surveyor to attend to requisitions provided the responsible surveyor advises the DNR in writing giving details of:

- ◆ the name of the other Licensed Surveyor being authorised to attend to requisitions;
- ◆ the period of such authority;
- ◆ any conditions on the Authority; and
- ◆ the acceptance of the authorised Surveyor, to attend to the requisitions.

The Registrar may also issue requisitions to the lodger on matters of title on the plan or associated documentation.

6. AMBULATORY BOUNDARIES

See also 6.3 High Water Mark (Page E3-24), Part E2 Survey Plan Guidelines 1.69 Watercourses

In this document, ambulatory boundaries (unless specified otherwise) refers to both tidal and non-tidal situations. In general, surveys which include ambulatory boundaries need to be assessed by Departmental surveyors, even if they are submitted by an accredited surveyor. This assessment should in the first instance, be limited to confirmation that the ambulatory boundary is more or less positioned in the same location as on the previous surveys. If this is the case, and no encroachments exist, a plan may be processed without further assessment.

Where the new ambulatory boundary is shown in a different location to previous surveys, this matter must be investigated to confirm that the appropriate action has been taken.

6.1 Non Boundary Watercourses

The beds and banks of non boundary watercourses are usually included within the original grant. The control of the flow of the water rests with the Department of Primary Industries (Water Resources).

When a parcel of freehold land with an internal watercourse is subdivided and the watercourse (or part of the watercourse) is adopted as the boundary of the new lots (i.e. the watercourse is not included within any of the new lots), then that watercourse (or part thereof) may be given a lot number and noted as Public Use Land or the creek may be absolutely surrendered to the State.

6.2 Boundary Watercourses

See also 1.67 Survey Records (Page E3-37), Part E2 Survey Plan Guidelines 1.53 Reserved Esplanades and 1.69 Watercourses

The direction of flow of a non-tidal boundary watercourse must be clearly indicated by an arrow pointing in the direction of the flow (i.e. downstream). Where it is necessary to indicate the left or right bank of the watercourse, this will be taken in relation to the direction of flow.

Section 6 of the RWWCU Act changed boundaries from the centre thread of a stream (ad medium filum) to its banks.

When locating the position of the bank of a watercourse, surveyors should consider the definitions contained in the WR Act for "Bed" and "Bank".

A check of the original Deed of Grant should also be made to ascertain the actual description of the ambulatory boundary.

Where a bank of a watercourse has disappeared (e.g. by filling) and where the previous watercourse traverse is not re-run, but the traverse and offsets are used to calculate the area, the original traverse dimensions shall be shown as original in a traverse column on the face of the plan together with a note stating that the original offsets which come from the field notes of the original survey have been used to calculate the area.

If, in the above case, the previous survey records cannot be located, the position of the watercourse may be determined by scaling off the original plan.

Where the previous watercourse traverse is re-run and the original offsets are used to calculate the area, survey records may be required to be lodged with the plan.

6.3 High Water Mark

See also Division 2 of the Surveyors Regulations

High Water Mark shall be the feature to be adopted as the boundary where land abuts tidal waters and is described as being bounded by, for example, HWM, Ocean, Coral Sea, Bay etc.

See also Schedule 6 of the L Act for the definition of High Water Mark and Sections 8—13 of the L Act.

6.4 Changes in Ambulatory Boundaries

In a strict legal sense, the limit of land bounded by a river or stream is the bed and banks of the watercourse or HWM, and not necessarily the position where the surveyor thinks or locates those limits to be. That is to say, at a point in time, the owner of land bounded by a watercourse will hold the same land, no matter which plan is the relevant registered plan or what feature has been adopted by the surveyor. In the last resort should the matter result in a legal dispute a court will decide the boundary position.

Where an ambulatory boundary deviates significantly from the position determined in an original survey, each case will be decided on the basis of the relevant legislation, case law, present evidence on the ground, previous legal opinions and the original survey to ensure that interests of the State and the registered owner are protected.

It is the responsibility of a Licensed Surveyor to reinstate any boundary after considering all the facts (evidence) which may influence that decision. This includes ambulatory boundaries.

Any change in the location of an ambulatory boundary must be justified in accordance with the doctrine of "slow and imperceptible" movement. The onus of "proof" lies with the claimant.

The construction of a retaining wall outside the line of natural ambulatory boundary does not, in itself, alter the boundaries of a lot. Encroachments over ambulatory boundaries are unacceptable and must be resolved with through a State Land Administration Sub-Program action. This may require the creation of a right line boundary. Encroachment in this context applies to any manmade structure or improvement, noting that it usually applies to buildings, but in the case of ambulatory boundaries, would include any construction of rock (or other substance including landfill) walls beyond the original ambulatory boundary, i.e. reclamation.

If by extending original boundaries to intersect the new ambulatory boundary, the rights and interests of adjoining owners are affected, or may in the future be affected, the extension of the original boundary should be at made right angles to the centre thread of the stream.

Note: To assist in the examination of plans of survey that purport to "redefine" an ambulatory boundary, regardless of what caused the necessity for the redefinition, the following information must be deposited as survey records, regardless of whether the surveyor is accredited or not:

- ◆ Substantial report addressing;
 - location as determined by original surveyor and any subsequent surveys;
 - extant evidence of determination by previous surveyor(s);
 - stability and permanency of the feature(s);
 - application of statute to the new determination;
 - relevant photographs demonstrating case; and
 - a specific statement as to whether the movement is significant or not significant. (see below)
- ◆ Evidence that the new boundary does not affect or encroach onto the property on the opposite side;
- ◆ Copy of subject plan showing, plotted on the face, the boundary position as determined by previous surveyors;
- ◆ For cases of significant movement or difference, a report on the investigation undertaken to establish that such movement has satisfied the doctrine of accretion (or erosion). If this doctrine can not be satisfied, then on what basis is the additional land claimed; and
- ◆ Such other evidence as is considered appropriate.

The word significant is used above. The following is part of an opinion by the Principal Legal Officer in the DNR where he notes the presence of the word "significantly" in Section 358(2) of the L Act and states:

¹"In my opinion, the presence of the word 'significantly' in paragraph (b) is important."

"The word 'significant' is defined by the Shorter Oxford English Dictionary to mean, among other things, 'important' or 'notable', while the Macquarie Dictionary gives its meaning as 'important' or 'of consequence'."

"Thus in the context of the question (whether Section 358(2) must be used to adjust an ambulatory boundary that has had slow and imperceptible movement, either erosion or accretion), the provisions of Section 358(2) need not be implemented unless it can be shown that the change in the boundary has been significant. As to what is a significant change in any particular case will be a question of fact to be answered by appropriately qualified persons by reference to all of the relevant circumstances affecting that case."

In dealing with movement of ambulatory boundaries, a surveyor should provide sufficient information in his report to justify his determination as to whether the movement of such a boundary is significant or not significant. In making his determination, the following factors should be considered:

- ◆ The location, value, zoning and size of the parcel affected by the ambulatory boundary;
- ◆ The extent of the change;
- ◆ The age, accuracy and scale of the original determination; and
- ◆ The regulations in force at the time of that determination.

In general, the DNR would consider movement to be **not significant** where the differences can be explained by:

- ◆ differences in measurements caused by differences in measurement techniques;
- ◆ errors in scaling off an old plan;
- ◆ an obviously erroneous location of a watercourse boundary;
- ◆ minor differences in location;

The DNR reserves the right to carry out its own investigation and inspection of any ambulatory boundary that has moved and to make its own assessment as to whether the movement is slow and imperceptible, and or significant or not significant.

6.5 Title Amendment for Riparian Boundaries

- ◆ Title Amendment where the movement, whether accretion or erosion, is slow and imperceptible and **not significant**:

Where it is found upon resurvey of a freehold riparian boundary that, according to the interpretations of the laws in place at the time of resurvey, the watercourse or high water mark boundary has moved by slow and imperceptible means, and that the difference is not significant, the riparian boundary may be adjusted to the new determination by the lodgement and registration of a freehold plan of resurvey. (Section 150, LT Act) (See also Section 9(2), L Act)

- ◆ Title Amendment where the movement, whether accretion or erosion, is slow and imperceptible and **significant**:

Where it is found upon resurvey of a freehold riparian boundary that, according to the interpretations of the laws in place at the time of resurvey, the watercourse or high water mark boundary has moved by slow and imperceptible means, and that the difference is significant, the riparian boundary may be adjusted to the new determination by the lodgement of a State Land Plan of resurvey, and the surrender of the current title to the land and regrant of a new deed under the provisions of Section 358(2) of the L Act. (See also Section 9(2), L Act)

- ◆ Where the movement, whether addition or loss, is not slow and imperceptible:

Where it is found upon resurvey of a freehold riparian boundary that the watercourse or high water mark boundary has moved by other than slow and imperceptible means,

¹ Principal Legal Officer, Department of Natural Resources 1995

including by reclamation or dredging, the riparian boundary may be adjusted to the new determination by the lodgement of a State Land Plan of resurvey, and the surrender of the current title to the land and regrant of a new deed under the provisions of Section 358(1) of the L Act.

In the case of addition, arrangements must be made with the DNR to purchase the additional land. (See also Section 10, L Act)

In certain cases, some of the land abutting a riparian boundary may, on investigation, be considered to be by accretion while the balance may be deemed to be reclaimed. The land that is deemed to be accreted, is included at no cost, while the reclaimed land has to be purchased from the State. The different areas shall be delineated on the plan, given an area and covered by appropriate action statements.

In the case of loss, i.e. by dredging, it may be possible to deal with the amendment of the riparian boundary by the lodgement and registration of a freehold plan of survey subdividing the lost land off into a lot for transfer to the State. Application should be made to the DNR to ensure they will accept the transfer. If this approach is adopted, the boundary between the land retained and the land to be transferred, although shown as a curvilinear boundary is not considered to be an ambulatory boundary. Generally, this method of dealing with a loss is not recommended.

6.6 Natural Features as Boundaries

See also Section 24.(2) of the Surveyors Regulation

For an example of a cliff boundary See RP97503.

7. EASEMENTS

See also 21 Easements: Page E3-103

7.1.1 General

Where an easement is to be created that affects multiple parcels, a separate easement is required for each parcel of land. (LT Act)

Overlapping Easements are permitted. The plan of a new easement must show any registered intersecting easements, but it is not necessary to mark their intersections. Other existing registered easements should be shown if they are located adjacent to the new easement or would otherwise be required as adjoining information.

A Easements may be created which are restricted vertically. (See also Direction 25 Volumetric Format Plans: Page E3-121)"

An Easement "in gross", that is an easement where there is no dominant tenement lot, may be created by a Statutory Authority for a public purpose such as drainage.

An easement may be surrendered, amended, merged, absorbed or extinguished.

An acceptable severance closure between the easement and lot boundaries in accordance with the Surveyors Regulations is required. Where a satisfactory close cannot be obtained, sufficient check measurements should be shown in the survey records to ensure the integrity of the surveyor's own work.

7.2 Definition of Easements

Plans defining easements shall be dealt with under the provision of Part 6, Division 4 of the Land Title Act.

Where the easement document:

- a. accompanies the plan, the easement description shall not be prefixed with "proposed";
- b. does not accompany the plan, the easement description shall be prefixed with "proposed".

The purpose of the easement or easements is not shown on the face of the plan.

7.3 Easement Areas by Balance

The area of an easement may be deduced as a balance area in the same way that a balance area is deduced for a lot.

7.4 Easements in Common Property Within a Building

See also 21.5 Restricted Easements: (Page E3-103)

Easements that are created within common property within a building must be either Restricted or Volumetric depending on the circumstance.

7.5 Easements by Court Order over Encroachments

A An order of the Supreme Court may require the creation of a benefit easement to cover encroachments of a building on to adjoining land. For a Court Order under the PL Act see RP838974.

7.6 Easements by Resumption

See 1.2 Acquisition of Land (Page E3-5)

7.7 Easement Descriptions

Letters used to describe easements should not be repeated either within the one plan or within the one lot. This also applies to previous easements within the lot or lots on the plan irrespective of whether the easements are registered or not.

Where more than one easement is surveyed on the one plan, they should be named consecutively.

When the alphabet has been exhausted to Z, easements may be described as AA, AB etc. "Emt" represents an acceptable abbreviation for "Easement" when used in the title block or on the face of survey plans.

Easements on both freehold and state land must be described as Proposed Easement (Alpha) in Lot (Numeric), subject to exceptions described in 7.2 above.

Where an easement is to be created in an existing lot:

Proposed Emt A in Lot 1 on RP123456

Subdivisions with Easements in the new lots should be described as:

*Lots 1 to 5 and Emts B, J & E in Lots
3, 4 & 5 respectively*

Cancelling Lot 1 on RP123456

Easements in Common Property in a Community Titles Scheme should be described as:

*Proposed Emts B, J & E in Common Property of
Community Title Scheme "Scheme Name" <CMS Number>*

Easements in Common Property in a Community Titles Scheme where the Common Property was created on different plans, should be described as:

*Proposed Emts B, J & E in Common Property of
Community Title Scheme "Scheme Name" <CMS Number>
(CP on SP123456, SP134562 and SP154328)*

where the common property was created on multiple plans the common property must be shown in the lot allocation table with the easements allocated (See Table 2 Lot and Common Property Allocation 4.1 Lot Allocations Page E3-17 for and an example)

Subdivisions with Easements created in adjoining Lots should be described as:

*Lots 1 and 2
Cancelling Lot 1 on RP123456 and of
Emt G in Lot 2 on RP45678*

This is only permitted when both lots 1 & 2 are in the same ownership.

Resurveys with an Easement in the same parcel should be described as:

*Lot 24 being a Resurvey of Lot 24 on RP123456
and of Proposed Emt E in Lot 24
Cancelling Lot 24 on RP123456*

Resurveys with an Easement in an adjoining Lot should be shown as:

*Lot 217 being a Resurvey of Lot 217 on RP123456
Cancelling Lot 217 on RP123456
and of Proposed Emt G in Lot 218 on RP123456*

7.8 Easements in Favour of Leases

Where a lease is registered over freehold land and an Easement is granted by the Lessor to the Lessee to access the lease, such an easement is therefore part of the lease and is automatically cancelled when the lease expires.

7.8.1 Easements over Reserves

Easements may be created over any reserve dedicated under the L Act. However, there are no provisions in legislation that allow for the resumption of an easement over a reserve dedicated under the L Act.

Where a reserve dedicated under the L Act has an easement registered against it, and a lease under the L Act has been applied for which will affect the existing easement, it shall be a requirement that the applicant arrange for the creation of a new easement over the new lease and for the subsequent surrender of that part of the easement covered by the lease.

Note: Under the provisions of *Chapter 5, Part 3 Division 1 Resumption of a lease or easement of the L Act*, the extinguishment of an easement over unallocated State land or a reserve is a resumption.

7.8.2 Easements in Leases over Reserves for State Forest or National Park

State Forests and National Parks are not reserves dedicated under the L Act.

Easements cannot be created within State Forest or National Park either by resumption or by agreement.

Where a lease issued under the L Act exists over any Reserve, including State Forest, National Park or Park and Recreation, etc., an easement may be created within the lease. An easement may be resumed from the lease. The easement is extinguished at the expiration of the term of the lease.

The easement must be described as:

Easement <alpha> in Lease <alpha> on <plan that created the lease>

7.9 Easements over State Land in Favour of Freehold Land and Vice Versa

A In instances where freehold and non-freehold land are the servient and dominant tenements of an easement or vice versa the documents for the easements must be lodged in duplicate for recording against both the freehold and non-freehold land.

7.10 Easements over Undescribed Balances

See also note regarding the future of Undescribed Balances in 11.15 Undescribed Balances (Page E3-49)

Easements over undescribed balances must be described as Proposed Easement A in Lot 1 on RP121345, where Lot 1 on RP 121345 is the original parcel.

7.11 Easements over the Whole of a Lot

Where an easement is over the whole of a lot, a plan of the easement is not required. In subsequent plans it is shown as an encumbrance on the plan in the normal manner with the description "Lot 1 on RP123456 (Easement), <Dealing Number>". Note that if the easement covers the whole of the lot in area, but is restricted, a plan of the easement is required in the normal manner.

7.12 Easement Titles

- A In rare cases, titles for Easements have been issued. See Title 10967023 or Title 11685016/17 and RP50663.

7.13 Local Government Consent

- A Local Government consent is only required for an instrument of easement which is for access purposes to a road. See LG(P&E) Act Sec 5.12. Where Local Government consent is required, this is contained in a Consent (Form 18) which is lodged with the instrument of easement. However, if the provision of an access easement is part of a conditional consent on a plan, this constitutes the Local Government consent to the easement and a specific consent is not required to be attached to the easement document.
- A While it is not necessary for Local Government consent to be endorsed on an easement only plan, if the Local Government elects to endorse an easement plan, any condition in that consent must be complied with, subject to the usual restrictions on conditions. If the consent is out of date, it must be resealed or the original consent deleted by the Local Government.

7.14 Long Line Utility Easements

The intersection of easement boundaries with surveyed lot boundaries must be reinstated and appropriately marked.

Long line utility easements may be accepted with calculated side boundaries.

Easements with calculated boundaries must conform with the following criteria:

- ◆ There must be a visible feature or a proposed visible feature that is an integral component of the easement;
- ◆ Connections to structures within the easements and the description and identification numbers of the structures must be recorded;
- ◆ The centreline or an offset from the centreline of the easement must be traversed;
- ◆ Where an engineering survey has been carried out along the easement, sufficient connections must be made to relate the two surveys to each other;
- ◆ The traverse should close with original boundaries. Where a satisfactory close cannot be obtained, sufficient check measurements should be shown in the survey records to ensure the integrity of the surveyor's own work.;
- ◆ Each bend is marked with boundary marks and recovery marks
- ◆ Boundary marks and recovery marks are placed at appropriate spacings along the corridor, nominally 1 km;
- ◆ Permanent Marks are placed or located at strategic locations along the corridor, nominally 5 km intervals; and
- ◆ The easement boundary dimensions must be shown as calculated but line pegs are not required to be placed on the calculated lines.

7.15 New Lot Boundaries Intersecting Existing Easements

Plans of lots are required to show the intersection of new boundaries with registered easements. Sufficient information must be shown on the plan to position the intersections of easements with new boundaries. This information may be calculated. It is not necessary to dimension the boundaries of registered easements within the new lot/lots. While a calculated intersection (between new boundaries and existing registered easements) is acceptable it is still the surveyors responsibility to ensure that easement encumbrances are correctly carried forward to affected lots.

Where lots are within a building on a Building Format plan, intersections need not be calculated. However, they must be plotted on each level. Where a part of a lot is fully dimensioned and outside a building, calculation of intersections is required.

The intersections of new lot boundaries with existing registered easements may be marked on the ground.

7.16 Road Dedications over Easements

Where a road is dedicated over a registered easement (other than an easement of Right of Way or an easement for Local Government purposes to the Local Government consenting to the plan) by plan or by document, the consent of the grantee of the easement is required.

Where the grantee is a Public Utility, the approval should be on a Consent (Form 18 LT Act), properly executed by the Local Government approving the dedication.

A notation must be made on the reverse of the plan that:

"Emt A on RP<number that created the easement> partially/fully absorbed by new road."

7.17 Subsequent Plans over Surveyed Easements

See also 7.7 Easement Descriptions (Page E3-29)

Where a plan has been registered cancelling a lot over which an easement has been surveyed, that easement, if unregistered, may proceed to registration. If the easement is registered, it may be the subject of another easement, at a later date. These dealings, above, may only occur if the boundaries of the easement have not been altered or amended in any way, or have not been intersected by a boundary of a new lot on any subsequent plan of subdivision.

Unregistered easements shall not be shown on any subsequent plan unless and until they become registered.

Registered easements shall be shown on all plans subsequent to their registration.

The requirement that easement letters should not be duplicated within any lot or plan applies equally to unregistered easements as to registered easements.

7.18 Creation of New Easements on Land being Transferred to the State

Following registration of a plan transferring land to the State, future easements may only be created on a State Land Action Plan using the provisions of the L Act.

7.18.1 Creation Prior to Transfer

- A** Where new easements for public utility purposes are required on land that is to be transferred to the State on registration of a plan, the easements must be registered prior to the registration of the plan. Once registered, the easements can be dealt with as noted in 2.6 Transfers to the State (Page E3-10).

7.18.2 Creation Following the Transfer

Following registration of a plan of subdivision showing Public Use Land, or following transfer of a lot to the state, any easements required must be created on a State Land action plan.

- A** It is no longer possible for a Local Government to make registration of a plan of subdivision conditional on the registration of such easements. If these easements are required, they should be registered to precede the plan of subdivision.
- A** Note that only easements for Public Utility purposes may be carried forward, and then only with the consent of the Minister.

7.19 Deemed Tramline Easements

The centreline of the tramline line must be located relative to the lot boundaries. There is no requirement to mark the easement boundaries or their intersection with the lot boundaries

Recovery marks must be placed near the intersection of the centreline with the lot boundaries as well as at the tangent points and traverse points on curves.

The plan must show the dimensions of straights and chords, the radii of curves, areas of the easement and the recovery marks placed.

8. LEASES

8.1 Leases (L Act)

Land below HWM may be leased under the provisions of the L Act

8.1.1 Sublease of a Lease or a Trust Lease of a Reserve

Subleases of a Lease or a Trust Lease of a Reserve (e.g. Park) require the approval of the Minister responsible for administering the Land Act. A State Forest or National Park is not a reserve under the L Act.

The Minister may require either a sketch plan or a normal plan of survey to be used to describe the sublease, or Trust Lease of a Reserve.

The sublease must be described as:

Lease <alpha> in Lot 243 on <plan>

8.1.2 Leases over the Whole of the Land

See also 7.7.1 Easements over Reserves (Page E3-29) and 7.7.2 Easements in Leases over Reserves for State Forest or National Park (Page E3-29)

Where a lease is over the whole of a lot, a plan of the lease is not required. In subsequent plans it is shown as an encumbrance on the face of the plan by a statement such as: "Lot 1 on SL12345 is subject to Lease A on CP896532."

8.2 Leases (LT Act)

8.2.1 Leases by Sketch Plan

Section 65(2) of the LT Act states the requirements for an instrument of lease of part of a lot or part of a building: See also Direction 20 Sketch Plans: (Page E3-99).

Where it is desired to restrict a lease vertically, it shall be dealt with as directed in Direction 25 Volumetric Format Plans: (Page E3-5).

8.2.2 Leases by Registered Plan

Leases drawn on a common plan form lodged for registration must comply with all the requirements of a normal plan of subdivision.

Some examples are:

- ◆ Jobja Farms. See RP198963;
- ◆ Toowong Railway Station. See RP211469;
- ◆ Toowoomba Airport. See RP194742;
- ◆ Brisbane Markets Trust. See RP209279
- ◆ Lease of Building on Registered Plan. See RP176225

8.2.3 Leases over the Whole of the Land

Where a lease is over the whole of a lot, a plan of the lease is not required. In subsequent plans it is shown as an encumbrance on the plan in the normal manner with the description "Lot 1 RP123456 (Lease), <Dealing Number>".

If the lease covers the whole of a lot in area, and it is desired to restrict it vertically, it shall be dealt with as directed in Direction 23 Standard Format Plans: (Page E3-107).

8.2.4 Road Dedication over Leases

See also 4.4.3 Existing Leases (LT Act) (Page E3-19)

Where a road is dedicated over a registered lease the consent of the lessee of the lease is required.

A notation must be made on the reverse of the plan that:

"Lease A on RP<number that created the easement> partially/fully absorbed by new road."

9. PLANS

See 12.2 Historical Plan Information (Page52) and Part E2 Survey Plan Guidelines 1.49 Plan Forms

9.1 General

All plans are now archived at the Landcentre, Rockhampton and Townsville.

The standard plan form (prefix SP commencing at SP100000) commenced in July 1997 and is used for all surveys.

An instrument, as defined under Section 4 of the LT Act, includes a plan of survey.

Freehold Plan/State Land Action Plan		
Prefix	Type of Plan	Other Information
SP	Survey Plan	Standard Plan Form
IS	Identification Survey	Standard Plan Format
AP	Administrative Plan	Used for administrative actions such as tree clearing permits, permits to occupy, various road actions.

Table 9 Current Plan Types

Within the DNR plans pass through various stages before the action depicted on the plan can occur. During these stages, the plan status is indicated by the following terms. (See following page)

Plan Process Stages	
Stage	Notation
Copy of Endorsed Plan from Accredited Surveyors	Deposited (DP)
Original Plan for Registration	Lodged (SP)

Table 10 Plan Process Stages

9.2 Redrawn Plans

A A plan may be redrawn using the same plan number. It is the surveyors responsibility to ensure that duplicate plans are not released for general circulation.

9.3 Cancelling Clauses

See also 9.4 Description (Page E3-36)

It is imperative that the "CANCELLING CLAUSE" be correctly completed in the Title block. The cancelling clause is an essential part of maintaining the history of the cadastre through the parent child relationship between the lots. This relationship is recorded in the CISP database and forms the cornerstone of the CISP historical searching facility.

For plans of freehold and non-freehold tenures, the plan must cancel the whole or part of a lot on a plan from which the current tenure is issued.

Common property in a cancelling clause shall be described as "Common Property of <Scheme Name> Community Titles Scheme <cms/cts number>. Community Titles Scheme may be abbreviated to CTS.

As this method of showing Common Property does not give the requisite linkages for CISP, the lot on plan descriptions of Common property shall be noted in brackets at the bottom of the title block. ie (CP on BUP123, CP on SP1234. As the CP/plan description is only incidental to and

not part of the cancelling clause noted in the preceding paragraph, it should be shown in a smaller font and must not be shown immediately after the description .

9.4 Description

9.4.1 General

See also Part E2 Survey Plan Guidelines 1.40 Lots

Each lot on a plan must have a unique identifying number (LT Act). In order to promote clearer parcel identification, it is preferable for Surveyors to minimise the use of the numeral "1" in plans containing one lot only.

The description of a survey including the cancelling clause must refer to a lot on plan description except for a plan of new only.

All parcels of land must have a lot on plan description. This includes canal, channel and drain areas.

9.4.2 Locality

Item 9 (Locality) of the plan form (Form 21 Version 2) should state the name of the City, Town, Suburb or District or describe the location of the survey in relation to a permanent feature or a published map. Where a Gazetted Locality name is available this should be used.

9.4.3 Easements

See 7.7 Easement Descriptions (Page E3-29)

9.4.4 Resurveys

See also Part E2 Survey Plan Guidelines 1.55 Resurvey

A full description is required.

EXAMPLE:

*Lot 1 being a Resurvey of Lot 1 on RP123456,
Cancelling Lot 1 on RP123456*

9.4.5 Old System Resurvey

H Where the plan is of an area not previously surveyed and shown on a prior plan, use the description as given in Lot conversion on Certificate of Title.

9.5 Original Portions

See also 4.2 Portion Allocations (Page E3-17)

The Original Portion number or numbers, or in the case of allotments of Sections, the Original Allotment and Section number or numbers must be placed in the "orig" section of Item 7 "Portion Allocation" of the plan form (Form 21 Version 2), even if no allocation of the original portion is required. Portion numbers must be obtained by a current Title Search from ATS.

Surveyors should note that an "original portion" can be:

- ◆ an Allotment of Section;
- ◆ a Suburban Portion;
- ◆ a Suburban Allotment;
- ◆ a Lot on Plan (in which case the lot on plan must be shown in full); or,
- ◆ any of the many other types of old descriptions.

Where the current D/G covers old "portions", and is not a Section 358 D/G, these old portions are of no interest, as the reservations they originally had are now superseded by the reservations in the new D/G. In these cases, the original "portion" is the latest description ("lot on plan" if it is shown that way), and there is no need to make any mention of old superseded portions on the plan.

Where there is confusion, advice may be sought from the local Senior Surveyor.

9.6 Public Use Land

See also 2.6 Transfers to the State Page E3-9

9.7 Accredited Plans

Accredited Surveyors must send a copy of endorsed plans to the Department as soon as the plan is endorsed. This will ensure that plans lodged for registration will not be delayed by administrative actions such as entry into the CISP database. Where survey records are to be lodged these must accompany the copy of the plan.

Surveyors depositing copies of endorsed plans will ensure the timely update of CISP, failure to do so will incur delays in the titling process, and inconvenience clients. Surveyors who continuously fail to lodge copies of their accredited plans in a timely way will be asked to show cause why their accreditation should not be withdrawn.

9.7.1 Endorsement of Plans by an Accredited Surveyor

Accredited surveyors shall endorse a plan as soon as practical following completion of their survey. Immediately following endorsement, a copy shall be deposited with the Department. It is considered by the Department that a plan is not acceptable for accreditation until the barcoded label has been attached. Consequently, all copies deposited under this requirement must show the label.

9.7.1.1 Self Endorsement

Plans are endorsed by completing item 11 of the survey plan (Form 21 Version 2) by:

- inserting into the "BY" field the name of the endorsing surveyor. In the case of a body corporate, this shall be the body corporate name;
- inserting into the "Date" field the date the endorsement was made. In the case of plans that are amended and re-endorsed, this date should be struck out and the new date inserted.
- The endorsement shall be signed by either;
 - the surveyor personally,
 - or in the case of a body corporate, by the nominated liaison officer.
- The designation of the signatory shall be noted, i.e. Licensed Surveyor, Licensed Surveyor/Director or Liaison Officer.

9.7.1.2 Third Party Endorsement

Plans are endorsed by completing item 11 of the survey plan (Form 21 Version 2) by:

- inserting into the "BY" field the name of the surveyor. In the case of a body corporate, this shall be the body corporate name;
- inserting into the "Date" field the date the endorsement was made. In the case of plans that are amended and re-endorsed, this date should be struck out and the new date inserted.
- The endorsement shall be signed by either;
 - the endorsing surveyor personally,
 - or in the case of a body corporate, by a Licensed Surveyor/Director.

- The designation of the signatory shall be noted, i.e. Licensed Surveyor, Licensed Surveyor/Director.

9.7.2 Alteration to Endorsed Plans Prior to Lodgement

All amendments to endorsed plans require a new copy of the plan to be submitted to the Department. This copy must be accompanied by a copy of the previously submitted plan that has the changes highlighted.

9.7.3 Re-Endorsement

Plans that have been amended prior to lodgement should be re-endorsed by striking out the existing date of endorsement and inserting the new date. The amendment must be initialled by the signatory noted in 9.7.1 or 9.7.2 as appropriate.

10. ROADS/RAILWAYS

See also Part E2 Survey Plan Guidelines 1.57 Roads

10.1 General

See also Appendix A Glossary of Terms (Page E3-55) for a definition of "Reserved Road" and "Road Reservation"

A road provides dedicated access to land.

10.2 Alignments

See also Part E2 Survey Plan Guidelines 1.5 Alignment Offsets

10.2.1 Declared Alignments

H Declared Alignments become boundaries. The declaration was made by the Minister for Local Government under Section 35(8)(7) of the LG Act 1936

H The provisions referred to above were repealed under the Local Government Act 1993.

S These plans are recorded in Departmental systems with a plan prefix of DA.

10.2.2 Official Alignments

H An Official Alignment, not being a Declared Alignment indicates a building line only, which may or may not coincide with the property boundary.

10.2.3 Notice of Realignment

Under Section 498 of the LG Act, a Local Government may cause any road to be realigned in order to widen the road.

Section 498(5) of the Act states "The Local Government must lodge a copy of the notice of realignment with the Registrar of Titles for the registration on the instrument of title to the land."

A search of ATS will reveal any Notice of Realignment.

When a Local Government does not proceed with a Realignment, Section 507 of the LG Act provides for the removal of a Notice of Realignment.

10.3 New Road

10.3.1 Freehold Action Plan

A plan of freehold land shall generally contain at least one lot, but may be of New Road only.

The total area of new road must be shown

The dedication of new road takes place when the plan is registered. See the LG(P&E) Act, Section 5.3.11.

10.3.2 State Land Action Plan

A An area may be excised for road purposes and opened as road by gazettal. The plan must bear an action statement indicating the area to be excised for each affected lot on the face to the plan.

For State Land, the dedication is by way of gazettal.

10.4 Reserved Roads and Esplanades

See also Part 2 Division 1 of the L Act.

Reserved Roads and Esplanades, either surveyed or unsurveyed, are shown on the face of a plan in a specific location and are also shown as being excluded from the parcel on the face of the plan. A reserved road may or may not be dedicated to public use as a road, and if it is planned to be used for access, its status should be referred to DNR for clarification before use. If the area is deemed to be road and is required for road, the area must be surveyed in its defined location and dedicated as road on that plan.

Reserved Roads and Esplanades do not require an allocation of the reservation to new lots when a parcel is subdivided since Reserved Roads and Esplanades are in fixed locations.

In the case of a survey which abuts or intersects a Reserved Road or Esplanade, all evidence, including physical evidence, should be provided by the Surveyor to justify its position. New boundary intersections are not required on a Reserved Road or Esplanade.

Reserved Roads and Esplanades cannot be burdened by an easement or lease. For easements through lots containing Reserved Road See RP194504.

If there is any doubt as to the position of the Reserved Road or Esplanade this should be brought to the attention of the local Senior Surveyor.

For a Reserved road used to form a new Lot See RP200018 and WD1943.

10.5 Road Closure

See also 2.3.1.2 Section 358 (L Act) Actions (Page E3-9)

- A** It is normal practice for the DNR to require a closed road to be incorporated with adjoining land by action under the L Act.
- A** However, provisions exist in the L Act to deal with a closed road, which becomes unallocated State Land as a separate parcel of land.
- H** Where a separate deed of grant was issued for closed road, past practice was to obtain an undertaking to amalgamate the closed road with adjoining land.

10.6 Road Names

- A** The Local Government is the street naming authority. Most plans pass through the Local Government process and are sealed by the Local Government, thus ensuring the correctness of road names.

10.7 Road Reservation

See also 1.5 Reservations in Title (Page E3-7)

A Road Reservation does not have a specific location within a lot and is State Land reserved from the title. Note that on some older plans, a Road Reservation is referred to as "Reserved for Road Purposes".

Areas shall be shown on plans as follows:

36.635	ha
3.075	ha Rd Resn
33.56	ha

The title issues for the Net area of the lot only.

10.8 Road Opening and Closure

Where a road is being repositioned by a simultaneous road opening and road closure it is not essential that the intersection of a new road and the road to be closed be surveyed, provided that the surveyed status of the amended road system and any affected land is maintained.

Under section 109 of the L Act, severances that are created as the result of a simultaneous opening and closure may be incorporated in the deed of grant provided that the adjoining titles are held by the same registered owner.

10.9 Esplanades

See 10.4 Reserved Roads and Esplanades (Page E3-40) and Part E2 Survey Plan Guidelines 1.53 Reserved Esplanades

A If upon alienation, an area of esplanade is set aside at a defined width from HWM along the sea coast or navigable rivers and creeks, the landward boundary of the esplanade is curvilinear and is parallel to HWM.

The landward boundary of the esplanade is fixed at the time of alienation, irrespective of when the feature was surveyed, and is not subject to accretion or erosion. (*McGrath v. Williams NSW Law Reports 1912 Vol XII.*)

The seaward boundary of the esplanade is subject to accretion and erosion.

To convert the landward boundary of an esplanade from a curvilinear boundary to a right line boundary, adopt lines between the offsets to HWM so as to substantially replicate the curvilinear boundary on the ground.

10.10 Rights of Way

Rights of Way were created on plans prior to 1890 and are a type of private road or easement. They were surveyed to provide alternative access to parcels which were created on the same subdivisional plan.

In most cases, investigation of departmental records shows that they are still contained in the original title. If their status has been investigated, a note will appear in the notings section of the plan. If in doubt as to their status, contact the local Senior Surveyor.

Their status is only important if they are adjoining or give access to the subject land of the plan.

10.11 Railway Boundaries

A Prior to 1914, railway land was not normally surveyed unless the land was being resumed from a surveyed parcel of land. Section 92(1)(3) of the Railway Act 1914 vested in the Commissioner of Railways, all land within railway fences. It is generally accepted that this section only applied to land fenced prior to 1914.

Where unsurveyed railway land is being surveyed the fence should be adopted if it was erected prior to 1914. (R Act)

The standard width for unsurveyed and unfenced railways is:

- 150 links (30.175) in urban areas; and,
- 300 links (60.35) in rural areas.

With the railway being centered on the centreline of the constructed rails.

(Intentionally Blank)

11. SURVEY

11.1 Areas

See also Part E2 Survey Plan Guidelines 1.8 Areas and 23.4 Part Lots: E3-107

11.1.1 Calculated Areas

A calculated area is preferred where lots close within prescribed limits.

Lots which show a calculated area must be deduced by closure and adjustment of the misclosure by the Bowditch method and shown:

- ◆ in hectares to four significant figures where the area exceeds one hectare;
- ◆ in square metres to the nearest square metre where the area is less than one hectare;
- ◆ in square metres to the nearest 0.1 of a square metre where the area is less than one square metre and the land is of high value.

11.1.2 Balance Areas

In the case of balance lots, a balance area is acceptable if that lot does not close within the prescribed limits.

Where a balance area may be adopted, the new net area is determined by adding or subtracting the new calculated areas (rounded as appropriate) from the existing net area of the parcel or parcels.

Note: There is no rounding off of this resulting area. However, the resulting area must not be shown to less than one square metre.

Balance or approximate areas must be qualified as such on the face of the plan.

For areas obtained by indirect means See RP203179.

11.1.3 Three Line Areas

See also 11.17 Vincula (Page E3-50)

The only cases where a three line area is required is where a Section 23 (L Act) Reservation is involved. These include Forestry Entitlement Areas, and any other similar reservation where a fixed area is involved, but which is not in a fixed location.

In all other cases, the only area to be shown is the true net area of the lot, regardless of other lots whether fully surrounded or not, or included roads etc.

11.1.4 Part Lots

Where a lot is in parts, the area of each part shall be determined by the requirements of section 11.1.1. The total area of the lot shall be the mathematical sum of the areas of the parts with no further rounding.

Note: Where a lot is severed by roads, watercourses, etc. it may be defined as either part lots or by using vincula. It is not permissible to mix vincula and part lots.

11.2 Close Limits

See Surveyors Regulation Sec 31. — Survey Accuracy

11.3 Compiled Plans

See also Section 26.(1) (e) and 26.(2) Surveyors Regulation 1992, Part E2 Survey Plan Guidelines 1.10 Buildings and 1.47 Original Dimensions

The compilation certificate on the face of the plan must be in accordance with Section 25 (Form 18) of the Surveyors Regulation.

Where there is evidence of building encroachments that affect the subject land, and the encroachment still exists, the encroachment must be carried forward on the new plan. The size, nature and location of the encroachment must be shown on the plan. This information may be compiled.

Compiled plans are subject to the following:

- ◆ Where the land is in a fully surveyed state all corners must have been previously marked;
- ◆ Dimensions of the boundaries may be compiled from any source that is part of a public record in accordance with Section 24.(5) and 25 of the Surveyors Regulation where this information provides a satisfactory closure for the subject lot;
- ◆ Where the lot closes within prescribed limits a calculated area is preferred;
- ◆ Where the lot does not close within prescribed limits the original areas must be added (the result is not rounded off). If the original areas are imperial, the areas must be added together first and then converted to the nearest square metre.

11.3.1 Amalgamation by Compiled Plan

See also 2.2 Amalgamations (Page E3-8)

Local Government consent is required. (LG(P&E) Act)

11.3.2 Subdivision by Compiled Plan

See also 1.71 Unsurveyed and/or Calculated Boundaries (Page E3-49)

Local Government consent is required. Calculated internal road boundaries may be used as new lot boundaries if the secants were originally surveyed and marked. (LG(P&E) Act)

11.3.3 Compiled Plans for Resumptions Affecting Consolidated Titles

See also 2.3.1.2 Section 358 (L Act) Actions (Page E3-9) for current requirements.

Where an existing consolidated title:

- ◆ was affected by a resumption action and;
- ◆ the resultant State Land Action Plan did not contain complete dimensions and areas for the affected parcels and;
- ◆ the owner is unable to obtain a certificate of title for the individual lots;

a request for the correction of the resumption plan should be lodged with the local Senior Surveyor. The local Senior Surveyor will arrange for the appropriate action at no cost to the applicant.

11.3.4 Compiled Plan of an Unsurveyed Parcel

The dimensions of the parcel should reflect the accuracy of the base information from which the dimensions were determined.

When a lot is surveyed off an unsurveyed lot, the balance lot may be shown on the same plan as the plan of survey. In these cases the provisions of Sections 24.(5) and 25 of the Surveyors Regulation apply.

The following scale may be used as a guideline for approximating dimensions:

BEARINGS	Nearest 0° 15'
DISTANCES	(According to Scale of Plans)
UP to 1:1250	Nearest 0.5 metre
1:1500 to 1:2500	Nearest 1 metre
1:3000 to 1:8000	Nearest 2 metres
1:10000 to 1:25000	Nearest 10 metres
1:30000 to 1:80000	Nearest 20 metres
1:100000 and above	Nearest 50 metres

Table 11 Rounding Dimensions for Unsurveyed Boundaries (Compiled Plans)

The accuracy for closure of unsurveyed lots must not be less than 1 part in 2000.

The "About" area must be shown to three significant figures only.

The Form 18 surveyor's certificate must include all of the information sources used in the process of compiling the plan and include such items as maps, aerial photography, sketches, reports, etc.

11.4 Confused Boundaries

Where a surveyor identifies a survey problem that is of such a nature that it affects a local community and a single client could not reasonably be expected pay for the rectification of the problem, a confused boundary area may exist. This does not apply to areas where the reinstatement of boundaries is merely difficult.

If the surveyor believes that a confused boundary area exists, it should be referred to the local District Office of the DNR for investigation and the client advised accordingly.

11.5 Curved Boundaries

Curved boundaries will be accepted by the DNR for new lot boundaries where the boundary is readily and unambiguously discernible on the ground at the completion of the survey as is required by Section 27(a) of the Surveyors Regulation 1992.

By way of example a curved boundary may be used where it coincides with a curved feature such as a canal wall.

Where a curved boundary is permitted, the boundary must be defined. For example a circular boundary must be defined by:

- ◆ tangent points of the curve; and
- ◆ bearing and distance of the chord between the tangent points; and
- ◆ radius; and
- ◆ arc length.

11.6 Dimensions

See also Part E2 Survey Plan Guidelines 1.27 Dimensions, 1.28 Distances and 1.47 Original Dimensions

Complete dimensions, including the total "through" distance for every lot or easement boundary, must be shown on the face of the plan for each lot or easement on that plan.

Distances shown on plans must be corrected so that they are a horizontal distance at the mean terrain height of the line.

This provision applies also to internal roads, lots, etc., except in cases where a lot with intricate detail is concerned, where this requirement may be relaxed. In the latter case full information must be shown adjacent to the internal road, lot, etc., noting the plans on which the dimensions may be found.

11.7 Encroachment

See also Section 26.(1) (e) and 26.(2) Surveyors Regulation 1992, Part E2 Survey Plan Guidelines 1.10 Buildings, Policy Document PUX/901/286 Roads Awnings and Verandahs — Trespass and PUX/901/285 Roads — Outdoor Restaurants — Trespass

The size, nature and location of the encroachment must be shown on the plan.

If an encroachment from an adjoining parcel is shown on the subject land, OR if there is encroachment from the subject parcel onto an adjoining parcel The surveyor should deposit evidence, in the form of field notes, that Section 26.(2) of the Surveyors Regulation has been complied with. The "Survey Records" box on the face of the plan should be noted accordingly.

Encroachments affecting State Land (including Public Use Land, Road, etc. ...) must be referred to the DNR as the adjoining owner.

11.8 Identification Surveys

See also Part E2 Survey Plan Guidelines 1.33 Identification Surveys

A copy of the plan must be certified by the surveyor under a Form 13 certificate of the Surveyors Regulation.

Identification surveys shall be presented in A3 size, and shall be numbered using a barcoded label affixed in the bottom right hand corner with the plan held in portrait mode. The label shall be affixed to the plan being deposited such that its long side is parallel to the short side of the plan form immediately adjacent to the margin.

Identification surveys are not generally examined or registered. However, on request and payment of a fee an identification survey plan will be examined, and if in order will be endorsed by the DNR. Details of identification surveys are recorded in CISP.

11.8.1 Placement of Additional Reference Marks on Subdivision Surveys

See also 5 CORRECTIONS TO PLANS (Page E3-21)

Surveyors dealing with subdivisions that involve considerable earthworks have lodged plans for registration that do not have all of the reference marks that are intended to be placed as part of the survey. In the past the Surveyors Book has been used as a means of adding additional reference marks to the registered plans for large estate subdivisions. Since the Surveyors Book is no longer in operation an Identification Survey plan must be lodged to record the additional marks associated with the subdivision.

In these cases the Identification Survey plan may be a reproduction of the registered plan annotated with the additional reference mark information. The requirements for plans produced by this method are that:

- any additional reference marks must be tabulated;
- the tabulation must clearly state - **Additional Reference Marks Placed after registration of SP987654;**
- the original form 13 certificate must be ruled through and a new, correctly executed, form 13 added to the plan;
- the title must indicate that the plan is an "Identification Survey of Additional Reference Marks affection Lots x on SP123456";
- an identification plan number (IS prefix number) in the form of a barcoded label must be affixed to the copy of the plan being deposited in the plan number box.

11.9 Meridian

See also Recommended Practice 105.0 Meridian Determination and Part E2 Survey Plan Guidelines 1.24 Datum and 1.42 Meridian

- A** The meridian of surveys should preferably be on the azimuth of the Australian Map Grid. The surveyor may determine the meridian by the most economical method which shall be noted in the meridian box on the plan. Where connections to coordinated marks are used, full details (including the AMG coordinates at the date of the survey) of these marks, and the direct bearing and distance, as derived from the survey, between them, shall be noted on the face of the plan, as well as a direct connection from at least one station of the survey to at least one of the marks.
- A** While it is desirable for surveys of less than 10 lots to be on the meridian of AMG, it may not be economically viable to do so. In such cases another meridian may be adopted.
- For all other surveys where a meridian other than AMG is used, the origin of the meridian used shall be noted in the meridian box on the face of the plan.
- On any lot where some of the boundaries are surveyed and the remainder are compiled the meridian of the compiled information must be on a meridian that is common with the surveyed component.
- A** As the concept of "datum" is now outmoded, it is no longer necessary to note any line on the plan as "datum".

11.9.1 AMG Connections

See also Part E2 Survey Plan Guidelines 1.7 AMG Connections and 1.42 Meridian

Whenever any survey has been connected to the survey control network AMG coordinates must be computed in accordance with The Australian Geodetic Datum Technical Manual — Special Publication Number 10.

11.10 New Boundaries

See also Section 24 of the Surveyors Regulation

- A** For surveys of non-freehold land that are based on a design of the proposed boundaries, it is the responsibility of the surveyor to maintain the intention of the design as evidenced by occupation (buildings, fences, etc.), topography, natural features, dimensions, etc.
- A** Where any major divergence from the design is necessary or where there are incompatible design specifications, approval of the relevant authority must be obtained for the changes.

11.11 Permanent Marks

See also Section 29 Surveyors Regulations, Recommended Practice 106.0 Permanent Marks

All surveys deposited with the Department of Natural Resources for registration must connect to a minimum of two (2) permanent marks. This requirement includes surveys on Standard, Building and Volumetric Format plans. Where existing permanent marks are not available a suitable permanent mark or marks must be placed.

The surveyor shall ensure that meridian of the survey is based on AMG as required by section 11.9 Meridian (Page E3-47).

Permanent Marks are not limited to the traditional brass plaques set in concrete but may include a range of options. To facilitate this the specifications for permanent marks have been revised using "performance criteria" rather than the previous prescriptive dimensional specification.

11.11.1 Specification for Permanent Marks

The Department does not intend to produce a rigid specification for Permanent Marks, rather the specification is based on the characteristics of such marks. In order for a survey mark to be accepted as a Permanent Mark it must conform to the following criteria:-

1. the mark must be made of a durable material, preferably metal;
2. when installed the mark must be permanent (i.e. have the expectation of longevity);
3. it must be capable of being readily identifiable as a survey mark;
4. it must be able to be identified with a unique Survey Control Number (as per the SCDB number) either on the mark itself or attached to the mark (e.g. on a concrete collar);
5. be recorded in the State's register of survey control points, currently the Survey Control Data Base;
6. the mark must be stable when installed; and,
7. must be capable of occupation.
8. marks should be capable of direct observation using GPS equipment.

11.12 Proclaimed Survey Areas

See also 11.9 Meridian (Page E3-47) and 11.11 Permanent Marks (Page E3-47)

PSA's are established under Section 12 of the Survey Co-ordination Act.

Surveys within or adjoining a PSA must connect to at least two established Permanent Marks. The PSA number must be shown on the face of the plan as near as practicable to the title block. (SCo Act)

The meridian of the survey must be AMG.

The bearings and distances between the PM's used shall be computed from the surveyor's own work. The results obtained are to be compared with the dimensions obtained from the coordinates of the PM's, having applied relevant geodetic corrections.

Proclaimed Survey Areas are located at:

- ◆ PSA 1 Toowoomba (Middle Ridge)
- ◆ PSA 2 Boonah
- ◆ PSA 3 Beenleigh
- ◆ PSA 4 Port of Brisbane
- ◆ PSA 5 Drayton (Toowoomba)
- ◆ PSA 6 Mount Isa

11.13 Resurveys

See also 9.4.4 Resurveys (Page E3-36)

Resurveys do not require Local Government consent.

It is preferable to use the original description as the new lot number.

There can be more than one resurvey on the one plan or a resurvey and new easement etc.

11.14 Survey Records

Survey records must be lodged where information cannot be conveniently shown on the plan. The survey records would include information such as reinstatement reports, creek traverses etc. Survey records for lodgement must be clearly identified as survey records and must include a completed Form 12 certificate in accordance with Section 33 of the Surveyors Regulation.

Sufficient survey records must be deposited with the plan of survey to ensure that a complete record of the survey is available to the DNR. The survey records need not be in the traditional field note form but should be no larger than A4. Survey Records must have a cover or cover sheet that contains the following information:

- a description of the survey (in most cases the Lots numbers being created);
- a description of the lots being cancelled;
- the Parish and County Names;
- the surveyors name; and
- the plan number to which they refer.

Ideally the cover or cover sheet should be of heavier grade paper than the other pages.

If a report is to accompany survey records the report and survey records must be the same size and be securely bound together.

- A** Surveyors should examine the original plans in their search for forward notings which may not be covered by CISP. These notings may be for Certificates of Alignment (CA) and Survey Records (Field Notes) for which no plan has been lodged. Such notings will normally be in the form "Resub 68 See CA 1234" or "Subs 1-3 of Resubs 113-115 See FN H 167", where H is the first letter of the surveyor's name. If in doubt regarding a noting or reference contact Department of Natural Resources, Survey Infrastructure Services Section, Landcentre, Woolloongabba.

11.15 Undescribed Balances - New Undescribed Balances Are Not Permitted

11.15.1 Development in Stages

Any plan which cancels an undescribed balance requires Local Government's consent, since it is deemed to be a subdivision under the LG(P&E) Act.

The description will be "*Lot cancelling balance of Lot ... on RP.....*".

11.15.2 Other Undescribed Balances

- A** Other undescribed balances such as access restriction lots (e.g. 3 link reserves) and Rights of Way have now been given Lot numbers in the Lot conversion process although not necessarily new titles.

11.16 Unsurveyed and/or Calculated Boundaries

See also 10.11 Railway Boundaries (Page E3-41) Part E2 Survey Plan Guidelines 1.11 Calculated Lines

Unsurveyed and calculated boundaries may be used as lot boundaries in the following circumstances.

11.16.1 Opposite Side of Road Unsurveyed

Where a road boundary is unsurveyed, but all its secant points on the unsurveyed side have previously been marked, the unsurveyed side may be used as a boundary. The distance on the

unsurveyed side must be shown either as original, if available on the original plan, or as calculated if not. In each case the boundary must be shown in full lines.

11.16.2 Other Unsurveyed boundaries

See also Part E2 Survey Plan Guidelines 1.11 Calculated Lines

- A** In general, the boundaries of a freehold parcel must be fully surveyed. However, small sections of boundary that can be calculated from other plans may be accepted in isolated areas.
- A** Where lengthy sections of boundaries have never been surveyed, for example in extremely rough and broken terrain, they may be accepted in a balance parcel.

The boundary must be shown as a full line, with a statement on the plan advising that specified lines on the plan have not been surveyed and that future actions (dealings) may require that these unsurveyed boundaries be fully surveyed. The dimensions shall be compiled from the original plan of the land, and a balance area determined.

EXAMPLE:

Lines ... have not been fully surveyed and future dealings may require these boundaries to be surveyed.

In cases of doubt, the local Senior Surveyor should be contacted for advice.

11.17 Vincula

See also 3.3.2 Agreements — LG(P&E) Act (Page E3-13) and Part E2 Survey Plan Guidelines 1.68 Vinculum

Vincula may be used to bind several parts of the same lot where the land is severed by:

- ◆ a watercourse;
- ◆ a road;
- ◆ a railway;
- ◆ a stock route;
- ◆ a channel/drain;
- ◆ a reserve;
- ◆ any other Transport Infrastructure corridor; or
- ◆ any combination of the above features;

provided that the Local Government approves the subdivision.

A vinculum cannot be used to bind together parts of land that are severed by lot(s) that do not form part of a Transport Infrastructure corridor. In this case, the provisions of Direction 23.4 Part Lots: (Page E3-107).

Where vincula are created:

- ◆ The parts of the land being bound must be adjacent across the dividing feature, for at least part of their frontages to the feature.
- ◆ The area of the lot may be calculated from the sum of the areas of each individual part, or be obtained by calculating the total area enclosed within the outer boundaries and subtracting the area of any enclosed feature. In either case, only the net area is shown. A three (or more) line area is not to be shown, unless there are Section 23 (L Act) exclusions. (See also 11.1.3 Three Line Areas Page E3-43)

Where one or more of the parts of a new lot is fully or partly surveyed along the dividing feature on the plan creating that lot, the relationship of those parts of the lot to each other such part must be clearly shown by surveyed connections.

Where one or more of the parts of a lot is compiled along the dividing feature, it is not necessary to show surveyed connections, but it must be possible to accurately plot the relative location of the parts of the lot from the relationships shown on previous maps or plans, or from other information acceptable to the Department (For example GPS connections). The meridian used must be common to all parts of the lot.

11.18 Profit Á Prendre

Profit Á Prendre is the right to take soil or produce (wood, turf, fish, etc.) from another's land or to graze animals on it. The right, like other interests in land, may be sold, bequeathed or otherwise dealt with. It is an encumbrance on the land and the title. Therefore the encumbrance must be recorded in ATS as well as being identifiable on the ground.

When a normal indefeasible title is surveyed an accurate survey is required. In the case of a Profit Á Prendre for forestry products, grazing, etc., they are essentially a short term tenure. In these cases a very high standard survey is not required. However, it is important the area of the Profit Á Prendre can be identified on the ground. Therefore the marking of the corners is an important element of the survey. Plan for Profit Á Prendre must be noted with the accuracy of the survey dimensions and type of mark placed at each corner.

The minimum requirements for the survey of Profit Á Prendre are set out in the following principals:

1. the survey and the associated plan must be capable of unambiguous interpretation;
2. the survey must be capable of recovery and reference marks must be placed;
3. the survey must be connected to an existing cadastral boundary by a minimum of two (2) connections so that the parcel can be positioned within an existing title;
4. the corners of the parcel must be marked with appropriate and durable marks;
5. an appropriate accuracy statement shall be placed on the plan;
6. a plan must be drawn and a surveyor's certificate placed on the plan;
7. the plan must be lodged with the Department of Natural Resources for registration.

11.18.1 Specifications

Based on these principals the following specification demonstrates how these principals may be applied to individual surveys.

1. The accuracies specified in this section are approved by the Department for use in surveys of Profit Á Prendre. They are approved under the provisions of Section 31(7) of the Surveyors Regulation.
2. Where a corner of a parcel lies on a boundary of the parent lot, a mark shall be placed on that boundary to standards as specified in Section 31(6) of the Surveyors Regulation.
3. Other corners may be located to a reduced accuracy which shall be no less than:
 - up to 10ha +/- 1m
 - 10ha to 50ha +/- 2.5m
 - over 50ha +/- 5m

The method of survey used shall be at the discretion of the surveyor.

4. The dimensions of each parcel shall be shown to the accuracy of the measurements. Where the dimensions are calculated from co-ordinates, the accuracy based on the accuracy of the co-ordinates.
5. The following shall be noted on the face of the plan:
 - description of the marks placed at each corner; and
 - where the survey is based on determination of the co-ordinates of the corners, a schedule of the determined co-ordinates and the method of determination; and
 - the accuracy of the location of the corner shown as a <+/- value>.
6. Sufficient connections shall be shown on the plan to reinstated corners of the parent lot to locate each parcel correctly within that lot. This connection shall be:
 - in bearing and distance format and shown as noted in 2 above; and
 - to an accuracy such that the parcel may be located to the accuracy specified for its area.

7. The surveyor shall affix to the plan the certificate required by the Surveyors Regulation.

Crown Action Plans		
Prefix	Type of Plan	Other Information
CP	Crown Plan	Common Plan Form
MPH	Mining Plan (Homestead Tenure)	No more plans being added to this series
SF	State Forest (Tenure description)	Dept of Primary Industries
NPW	National Parks & Wildlife	Dept of Environment and Heritage Plan
FTY	Forestry Plan	Dept of Primary Industries
RA	Road Action Plan	Department of Natural Resources
RX	Road Excision Plan	Department of Natural Resources

Table 13 Crown Action Plan Types

Freehold Plan/Crown Action Plan		
Prefix	Type of Plan	Other Information
DP	Deposited Plan	Common Plan Form
IS	Identification Survey	Common Plan Format

Table 14 Plan Types that are common to both Freehold and Crown Action Plans

A CISP may be used to check on the location or archival office of a plan.

12.2.1 Freehold Action Plans

In order to conform with statutory requirements under the LT Act the surveyors certificate must have been executed in accordance with the following timeframe:-

- ◆ Plans numbered 191500 to < 800000 executed by 30 June 1990
- ◆ Plans numbered 800000 to 863500 executed by 30 June 1994
- ◆ Plans numbered 863500 to 869500 executed by 31 March 1995

The Custodian for plans numbered between 1 and 799999 was as follows:

- ◆ Southern (Brisbane) 1 to 299999
- ◆ Central (Rockhampton) 600000 to 699999
- ◆ Northern (Townsville) 700000 to 799999

12.2.2 Crown Action Plans

In 1992, the County prefix for all Crown Action Plans was removed and replaced with the initials CP — Crown Plan.

While the "County prefix" is no longer used for Crown Action Plans the plan archive contains many plans that are catalogued in accordance with the historical "County" prefix.

(Intentionally Blank)

13. GLOSSARY OF TERMS

This Glossary of some of the most commonly used terms is intended to assist the user in understanding DNR Requirements. It is to be used in association with specific legislation.

Access

See also **Dedicated Access**

Under the LG(P&E) Act "access" is defined as a "practical" means of entry. However, practical means of entry does not always guarantee "dedicated access".

Access Restriction Lots

An access restriction lot is a separate lot in a subdivision. They may also be called buffer strips and are a town planning requirement of Local Government to restrict access from roads to adjacent land.

Administrative Advice

A document which is deposited by a local, commonwealth or state government authority or other authorised parties to record an interest in the lot in ATS. (e.g. Notice of Intention to Resume)

Allocation

Interests in land are carried forward from one title to the next through the allocation of the interests of old lots to the new lots. These interests may include easements, portions, mortgages, etc.

Associated Documents

Associated documents are instruments which are lodged in the DNR with the plan. e.g. Easements, Leases, Mortgages, Nomination of Trustees, Transfers etc.

ATS

ATS (Automated Titles System) is the computerisation of the Torrens Title System of registration for all Freehold and Leasehold dealings in land in Queensland.

Blind Roads

Blind roads are roads which have no access from a contiguous road system and are no longer of concern to the Registrar of Titles, being a matter for the Local Government.

Borrowing out of plans

Any unregistered survey plan lodged in the DNR may be borrowed out by the lodger for correction by the Surveyor. The amended plan must be returned to the DNR.

Calc Book

A numbered, linen bound book formerly held by each examiner. The book contained an index of all plans examined by that examiner. This has been replaced by CISP.

Caveat

A notice to the Registrar by a person claiming an interest in land. It prevents the registration of any instrument affecting such land until the caveat is withdrawn, removed or lapses. Caveats are recorded in ATS.

Certificate of Title

A certificate that may be issued by the Registrar that provides evidence of the ownership of a freehold interest in a parcel of land.

CISP

CISP (Computer Inventory of Survey Plans) is a textual data base of all survey plans in the DNR.

Comatose Title

This is the title to the underlying parcel of land over which a Building Unit Plan or Group Title Plan has been registered. Upon extinguishment of a BUP or GTP any dealing with the parcel will revert to this title. With the commencement of the BCCM Act all comatose titles will be cancelled.

Court Order

An order of the Supreme Court regarding the transfer of land or the creation of a benefit easement where an encroachment exists. No Local Government consent is required for the associated survey plan.

Crown land (Land Act 1962)

See State land.

Crown lease

A lease that is issued under the L Act.

Dealing

An action relating to a parcel of land, such as a transfer of interest.

Dealing Number

A unique number allocated to each document and survey plan when lodged in the DNR. It determines the priority of registration of plans and associated documents in relation to a title.

Dedicated access

See also Access

A dedicated road formed or unformed, surveyed or unsurveyed providing legal access to a lot, reserve or State land. See also Access LG(P&E) Act.

Deed of Grant

Means land granted in fee simple by the State or, the document evidencing the grant, including an indefeasible title under the LT Act. The deed is enrolled in the freehold registry and the registered owner's indefeasible title is created.

Deed of Grant in Trust

Means land granted in fee simple in trust by the State or, the document evidencing the grant, including an indefeasible title under the LT Act.

Deemed Tramline Easements

These easements are defined by law and were originally created by Section 41 of the Sugar Experiment Station Act 1900 and subsequently preserved by Section 84 of the Regulation of Sugar Cane Prices Act No 45 of 1962. The easement rights are now preserved under Section 203 of the Sugar Industries Act No 20 of 1991.

Defeasance

A condition relating to a title that can void the title if performed. Such conditions are contained in a separate instrument (not the title itself).

Deposited Plan

A plan or copy of a plan deposited with the DNR for the purposes of endorsement as being correct in respect of survey content. It includes:

- ◆ plans deposited for pre-examination and endorsement;
 - ◆ original State Land Action Plans deposited for passing and recording;
 - ◆ copies of plans endorsed by accredited surveyors, and;
 - ◆ plans that have been lodged for registration but are marked "No Further Action";
 - ◆ plans deposited pursuant to Section 30(1) of the Surveyors Regulation.
- See also Red Cat Plan

Easement

A right enjoyed over the lands of a registered owner. The Dominant Tenement is the land to which a right is granted. The Servient Tenement is the land that is burdened by the granting of a right to another parcel of land. For Easements in Gross there is no dominant/servient relationship.

Endorsed Plan

A plan which has passed survey examination and has been officially endorsed as being correct in survey content only for the intended action.

Fee simple

An estate of inheritance in land which is absolute and without limitation to inheritance. It implies full ownership in land, a tenure of which is called freehold.

Forest Entitlement Area

A reservation of commercial timber, and the land on which it stands, to the State in a deed of grant or freeholding lease to enable the State to undertake long term management of timber.

Freehold

Land which has been alienated from the State.

Freehold Title

An estate in fee simple created by a Deed of Grant when land is granted by the State or, an indefeasible title created on registration of subsequent dealings.

Fully Withdrawn Plan

A lodged plan that is no longer required to be registered by the interested parties. The consent of the Registered Owner or the lodger is required prior to withdrawal.

Geodetic Control Point

Positions established and marked on the ground which are coordinated in a geodetic coordinate system.

Geodetic datum

A set of constants used for defining the coordinate reference system for geodetic control surveys.

Holding

State Land held by any lessee. A "pastoral holding" is a State lease used for grazing purposes. (Land Act 1962) There is no definition of "Holding" in the Land Act 1994.

Indefeasible Title

The indefeasible title for a lot is created on the recording of the particulars of the lot in the freehold land register.

Identification Survey/Plan

A survey for the purpose of remarking existing boundaries. No interests are created or altered as a result of these surveys/plans. In general the survey content of these plans has not been examined.

Instrument

Instrument includes:

- ◆ a deed of grant or certificate of title; and
- ◆ a will, grant of representation, or exemplification of a will, that may be used to deal with a lot; and
- ◆ a deed that relates to or may be used to deal with a lot; and
- ◆ a power of attorney that may be used to deal with a lot; and

- ◆ a request, application or other document that deals with a lot and may be registered under the Land Title Act; and
- ◆ a map or plan of survey that may be lodged.

Interest in land

Rights, duties, liabilities connected with the land. The extent of the rights depending on the level of interest held; e.g. leasehold interest, freehold interest, joint interest, interest in common.

Lease (LT Act)

A lease is an instrument creating an interest in land for a fixed period, usually in consideration of the payment of rent. It is a requirement of a lease that there must be a Lessor, a Lessee, a demised premise or demised area and a term granted.

Leasehold

State land leased to a person or company, for a term of years or in perpetuity.

Lodged Plan

A plan which has been lodged with the DNR for the purpose of registration as an instrument to give effect to a dealing(s) and is recorded in ATS.

Lodgement

The act of acceptance for registration purposes, by a registering authority of a registrable instrument such as a plan of survey.

Lot (LT Act)

Means a separate, distinct parcel of land created on:

- ◆ the registration of a plan of survey; or
- ◆ the recording of particulars of a deed of grant.

Lot on Plan

Lot on Plan is a unique identifier for a parcel of land.

Notice of Intention to Resume (NIR)

A notice lodged in the DNR by a Statutory Authority of their intention to resume. It is noted in ATS as an Administrative Advice.

Nomination of Trustees

See Transfer to Trustees

Original Grant

The original Deed of Grant for any parcel of land issued by the State detailing therein the reservation of rights to the State.

Patent Error

A minor error on a survey plan which can be corrected by the Registrar pursuant to Section 155.(1) of the LT Act.

Proclaimed Survey Area (PSA)

When in the opinion of the Chief Executive of DNR, the state control survey has been sufficiently developed within any area, and Permanent Marks have been established over such area, the Governor-in-Council may declare such area to be a proclaimed survey area.

Public Use Land (LT Act)

Includes roads and other lots that are to be dedicated for public use on registration of a freehold plan of survey.

Red Cat Plan (Redundant Catalogue Plan)

A copy of a survey plan lodged pursuant to Section 30(1) of the Surveyors Regulation. The copy is held as a record of survey data only and as soon as the original survey plan is lodged the copy is no longer accessible. Derived from the term "Redundant Catalogue Plan Number" which was given to such a copy.

Register (noun)

A record of information about land maintained by the Registrar, under the authority of the LT Act i.e. the freehold land register.

Register (verb)

The recording of the particulars of a lot, interest, instrument or other thing in the freehold land register.

Registered Plan

A lodged plan which has proceeded to registration with or without accompanying documentation and is now recorded within the Land Titles Register.

Rejected Plan

A lodged plan that is prevented from proceeding to registration and is rejected by the Registrar. The original plan is returned to the lodger.

Requisition

A formal notification that a document has defects and those defects should be clarified or corrected before the document may be passed for registration.

Reservation in a deed or lease

A clause in a deed or lease where the grantor (the State) reserves something to itself, for instance gold and petroleum, or a certain amount of land within the lease or deed.

Reservation in title

Reservations in Title are areas of land set aside in Deeds of Grant for the express use of the State (Crown) in the process of the closer settlement of Queensland. They are non-delineated areas of land within the external boundaries of a lot (or other parcel of land). Reservations in Title are mainly for road purposes but can be for railway, telegraph, or other defined purposes.

Reserve

A parcel of land that has been set aside, through the provisions of the Land Act, for a community purpose; for example, for park and recreation purposes.

Reserved Road

A Reserved Road, either surveyed or unsurveyed, is shown on a plan in a specific location and reserved from the title. This may or may not be dedicated as a road, and if it is planned to be used for access, its status should be referred to DNR for clarification before use.

Resumption

The procedure under which an authority, empowered by the State Government, compulsorily acquires land for a specific purpose.

Road Action Plan

A sketch plan drawn for the purpose of road opening and/or closure under the Land Act.

Road Excision Plan

A sketch plan drawn for the purpose of excising an area of land from a Land Act lease for the purpose of dedicating the area as road.

Road Reservation

A Road Reservation does not have a specific location within a lot but is reserved from the title. Note that on some older plans, a Road Reservation is referred to as "Reserved for Road Purposes".

State Land (Land Act 1994)

All land in Queensland, except land which is, for the time being:

- ◆ granted or contracted to be granted in fee simple by the State; or
- ◆ reserved for or dedicated to public purposes; or
- ◆ subject to any lease or licence lawfully granted by the State (land held under an occupation licence is deemed to be State land).

Statutory Area

An area of land wherein either:

- ◆ another Statutory Authority, in addition to the Local Government, must consent to the plan e.g. within a Coastal Management Control District; or
- ◆ some extra condition must be complied with e.g. connect to Permanent Marks in a Proclaimed Survey Area.

Statutory Authority

An authority that is created through an act of Parliament.

Surrender

To surrender an interest in land (e.g. a lease) is to give it back to the person or body (e.g. the State) from whom it was granted.

Survey

The act or process of determining the form, contour, position, area, height, depth or any other similar particulars of the earth's surface, whether on land or water, or of any natural or artificial features on, below or above any part of that surface. It also refers to planning the position or the length and direction of the bounding lines of any part of that surface, or of any natural or artificial features, and includes the making or obtaining of a plan or plans.

Tenure

The form in which property is held or set aside, for example, freehold. Tenure is also used to describe an interest in land that has a term e.g. leasehold as opposed to freehold.

Transfer and Request to Amalgamate

The Transfer and Request to Amalgamate are documents used to resolve cases of joint ownership created by the movement of title boundaries by survey when two or more different registered owners are involved.

Transfer to Trustees (Formerly Nomination of Trustees)

This is the document which is often used in dealing with access restriction lots as it transfers the land to the relevant Local Government in trust usually for Town Planning Purposes.

Unallocated State Land

State land, as previously defined, but excluding land under occupation licence or some other interest.

Unregistered Dealing

An instrument which has been lodged with the Registrar but not yet registered.

Vacant Crown land

See Unallocated State Land.

Vested Land

State Land the control of which has been ceded to a Statutory Authority. e.g. Port of Brisbane.

14. ABBREVIATIONS

14.1 General

Title	Abbreviation
Automated Titles System	ATS
Australian Height Datum	AHD
Australian Map Grid	AMG
Building Unit Plan	BUP
Certificate of Title	C/T
Computer Inventory of Survey Plans	CISP
Contaminated Land	C/L
Crown Action Plan	CP
Digital Cadastral Data Base	DCDB
Deed of Grant	D/G
Deposited Plan	DP
Document Imaging of Survey Plans	DISP
Department of Natural Resources	DNR
Easement	Emt
Global Positioning System	GPS
Forest Entitlement Area	FEA
Freehold Action Plan	RP
Group Title Plan	GTP
Permanent Mark	PM
Proclaimed Survey Area	PSA
Resumption	Resump
Vegetation Protection Order	VPO

14.2 Crown Tenures — Land Act 1962

FREEHOLDING TENURES	Abbr	LEASEHOLD TENURES	Abbr
Agricultural Farm	AF	Grazing Homestead Perpetual Lease	GHPL
Auction Perpetual Lease	APL	Non Competitive Lease	NCL
Auction Purchase Freehold	APF	Pastoral Development Holding	PDH
Development Lease	DL	Pastoral Holding	PH
Freeholding Sale	F	Perpetual Country Lease	PCL
Grazing Homestead Freeholding Lease	GHFL	Perpetual Suburban Lease	PSL
Perpetual Country Lease Converted	PCL(C)	Perpetual Town Lease	PTL
Perpetual Lease Selection	PLS	Preferential Pastoral Holding	PPH
Perpetual Suburban Lease Converted	PSL(C)	Special Lease	SL
Perpetual Town Lease Converted	PTL(C)	Stud Holding	SH
Special Lease Purchase Freehold	SLPF		
Special Purchase	SP		
OCCUPATIONS	Abbr		
Occupation Licence	OL		
Permit to Occupy	PO		
Road Licence	RL		

14.3 State Tenures — Land Act 1994

FREEHOLDING TENURES	Abbr	LEASEHOLD TENURES	Abbr
Freeholding Sale	F	Term Lease	TL
Grazing Homestead Freeholding Lease	GHFL	Perpetual Lease	PPL
Freeholding Lease	FL		
PERMITS	Abbr		
Permit to Occupy	PO		
Road Licence	RL		

Department of Housing, Local Government & Planning

LEASEHOLD TENURES	Abbr
State Housing Freeholding Lease	SHFL
State Housing Perpetual Town Lease	SHPTL
Workers Homes Perpetual Town Lease	WHPTL

14.4 Acts and Regulations & their Abbreviations

The Acts and Regulations cited herein may not be a comprehensive list of legislation that affect the survey aspects of land transactions.

Title	Abbreviation
Current Legislation	
Acquisition of Land Act 1967	AofL
Beach Protection Act 1968 and Regulations	BP
Body Corporate and Community Management Act 1997	BCCM
Canals Act 1958 and Regulation 1992	C
City of Brisbane Act 1924	CofB
Contaminated Land Act 1991 and Regulation 1991	CL
Dividing Fences Act 1953	DF
Integrated Resort Development Act 1987	IRD
Land Act 1994 and Regulation 1995	L
Land Title Act 1994 and Regulation 1994	LT
Local Government Act 1993	LG
Local Government (Planning & Environment) Act 1990 & Regulation 1991	LG(P&E)
Mixed Use Development Act 1993	MUD
Property Law Act 1974 and Regulation 1993	PL
Registration of Plans (HSP [Nominees] Pty Ltd) Enabling Act 1980	RPHSP
Rights in Water & Water Conservation & Utilisation Act 1910 (Repealed)	RWWCU
River Improvement Trust Act 1940 and Regulation 1987	RIT
Rural Lands Protection Act 1985	RLP
South Bank Corporation Act 1989 and Regulation 1992	SC
State Housing Act 1945	SH
Survey Co-Ordination Act 1952	SCo
Surveyors Act 1977 and Regulation 1992	S
Transport Infrastructure Act 1994	TI
Transport Infrastructure (Roads) Act 1991 and Regulation 1991	TI(Road)
Water Act 1926 (Repealed) and Regulation 1991	W
Water Resources Act 1989	WR
Superceded and Repealed Legislation	
Building Units and Group Titles Act 1980 and Regulations	BUGT
Harbours Act 1955 (Repealed) and Regulations	H
Main Roads Act 1920 (Repealed)	MR
Miners Homestead Leases Act 1913 (Repealed)	MHL
Mining Titles Freeholding Act 1980 (Repealed)	MTF
Railways Act 1914 (Repealed)	R
Real Property Act 1861 (Repealed)	RP
Real Property Commonwealth Titles Act (Repealed)	RPCT
Transport Infrastructure (Rail) Act 1991 and Regulations (Repealed)	TI(Rail)
Workers Homes Act 1919 (Repealed)	WHC

(Intentionally Blank)

15. REFERENCE PLANS

The plans on the following pages are referred to in the text of these requirements. These reference plans are used to demonstrate specific requirements and should not be considered as being correct in all respects.

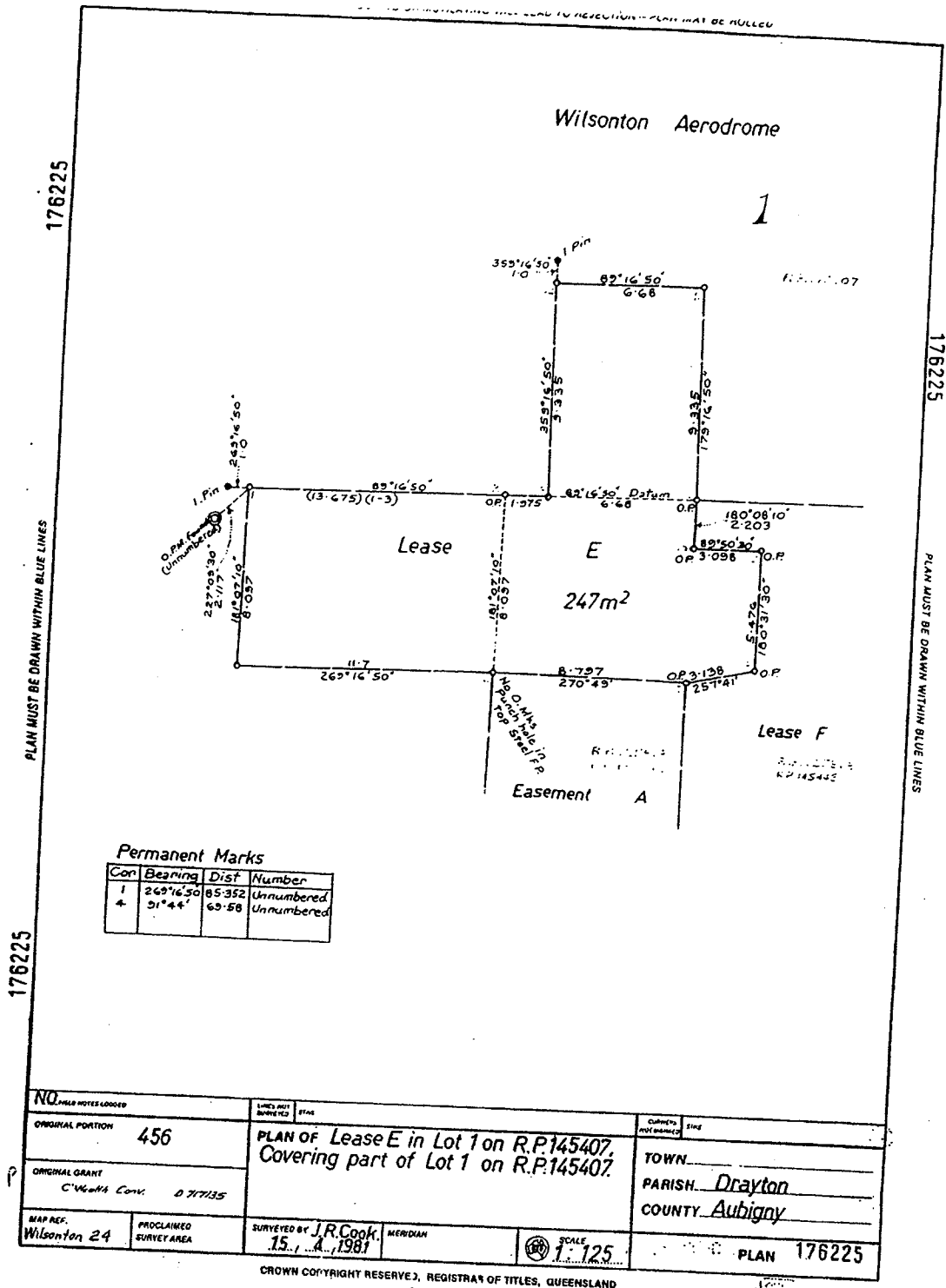

NO. OTHER NOTES LOGGED		LINES NOT SURVEYED	SCALE	Current to not shown	Size
ORIGINAL PORTION	456	PLAN OF Lease E in Lot 1 on R.P.145407, Covering part of Lot 1 on R.P.145407.		TOWN	
ORIGINAL GRANT	C'Waltha Conv. D 71735			PARISH	Drayton
MAP REF.	Wilsonton 24	SURVEYED BY	J.R. Cook	COUNTY	Aubigny
PROCLAIMED SURVEY AREA		DATE	15.1.1981	PLAN	176225
		MERIDIAN		SCALE 1:125	

CROWN COPYRIGHT RESERVED, REGISTRAR OF TITLES, QUEENSLAND

WARNING - FOLDING OR MUTILATING WILL LEAD TO REJECTION - PLAN MAY BE ROLLED

194504

194504

PLAN MUST BE DRAWN WITHIN BLUE LINES

PLAN MUST BE DRAWN WITHIN BLUE LINES

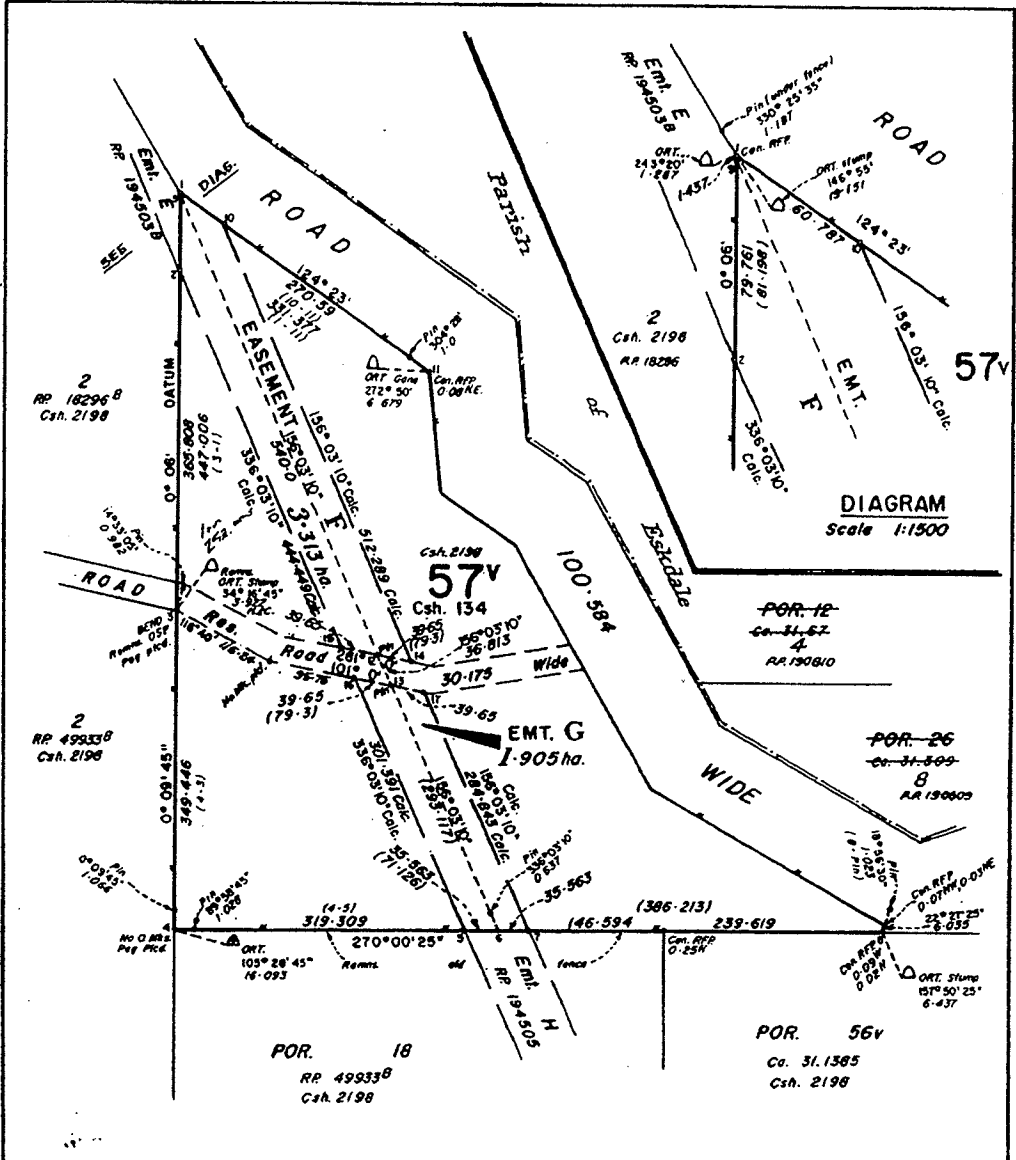

DIAGRAM
Scale 1:1500

Pegs branded AE placed at Stns.
2, 5, 7, 10, 14, 15, 16 and 17.

Amendments in red by me on 5.3.1966

D. Blakeney
Licensed Surveyor

REFERENCE MARK CONNECTIONS ARE FROM THE CORNER TO THE MARK.

194504

<p>REG. PLAN 194504</p> <p>ORIGINAL GRANT</p> <p>101470</p>		<p>PLAN OF Easements F & G in Portion 57V LOT 9057</p> <p>Governing part of Portion 57V on Csh. 134</p>		<p>ORIG. PORTION 57V</p> <p>TOWN</p> <p>PARISH EMU CREEK</p> <p>COUNTY Cavendish</p>	
<p>MAP REF.</p> <p>9343 - 44</p>	<p>PROCLAIMED SURVEY AREA</p>	<p>SURVEYED BY D.J. BLAKENEY</p> <p>13.1.66</p>	<p>MERIDIAN</p> <p>AG</p>	<p>SCALE</p> <p>1:4000</p>	<p>REGISTERED PLAN 194504</p> <p>(C.S.E.)</p>

CROWN COPYRIGHT RESERVED, REGISTRAR OF TITLES, QUEENSLAND A3-5-206243-01 TMC 31

WARNING - FOLDING OR MUTILATING WILL LEAD TO REJECTION - PLAN MAY BE ROLLED

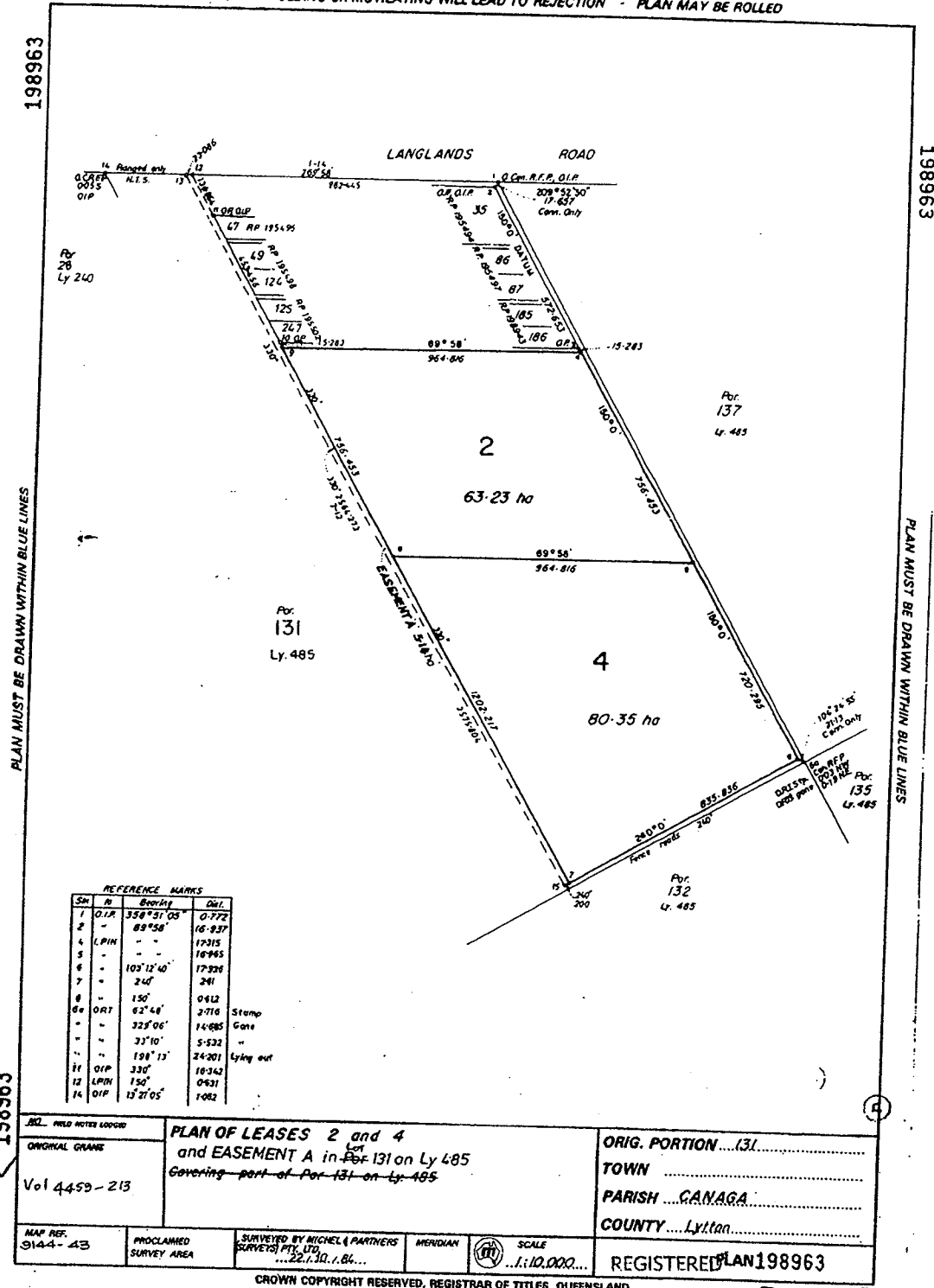

198963

198963

PLAN MUST BE DRAWN WITHIN BLUE LINES

PLAN MUST BE DRAWN WITHIN BLUE LINES

198963

B4 k1/240 WARNING - FOLDING OR MUTILATING WILL LEAD TO REJECTION - PLAN MAY BE ROLLED 1/11/75/1

200018

PLAN MUST BE DRAWN WITHIN BLUE LINES

200018

PN	BEARING	DIST	NUMBER
1 - PM W	89° 22' 15"	37.54	60902
9 - PM	354° 07'	1.324	91908

LINE	BEARING	DIST
11 - A	85° 04' 36"	96.234
A - B	8° 56' 28"	115.660
B - C	8° 06' 55"	56.077
C - D	30° 53' 05"	113.050
D - A	131° 52' 25"	34.448

STN	TO	BEARING	DIST	MARKS
1	OP	304° 00'	1.006	
2	OP	124° 46'	1.006	
3	OP	120° 30'	12.070	
4	OP	106° 17'	1.86	
5	OP	120° 30'	12.674	
6	OP	347° 11'	1.006	
7	OP	122° 33'	1.006	
8	OP	352° 33'	1.006	
9	OP	80° 28'	1.185	
10	OP	124° 46'	1.106	
11	OP	270° 18' 50"	1.00	
12	OP	69° 55' 25"	37.770	
13	OP	108° 31'	10.173	A.R. 15A
14	OP	30° 12' 50"	1.000	
15	OP	333° 04' 30"	4.831	
16	OP	30° 53' 05"	8.432	
17	OP	270° 42'	0.953	
18	OP	82° 30'	5.638	
19	OP	80° 14'	1.085	
20	OP	76° 07'	2.757	
21	OP	62° 30'	5.029	
22	OP	30° 53' 55"	0.772	

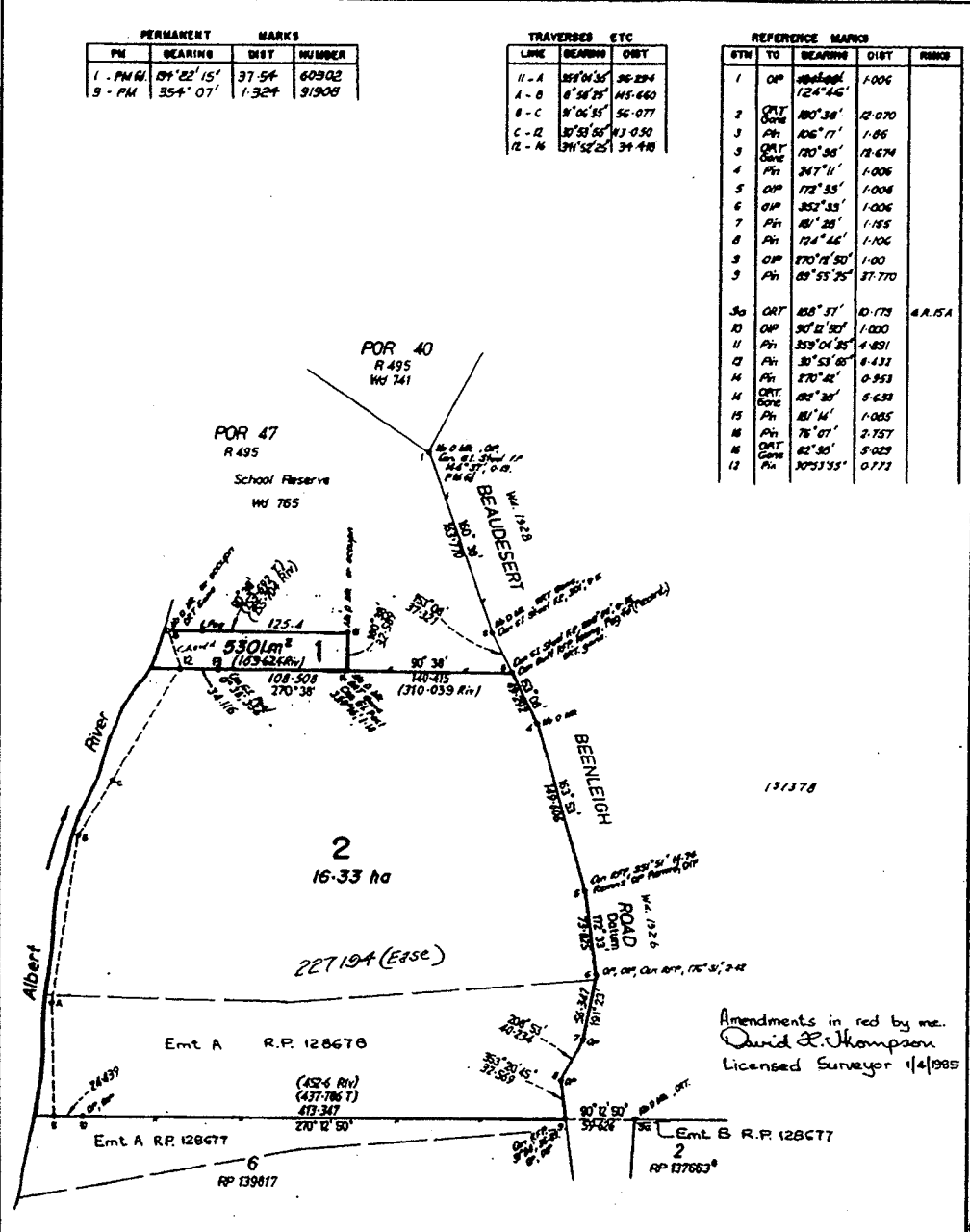

Amendments in red by me.
David E. Thompson
Licensed Surveyor 14/1985

FIELD NOTES LOGBOOK 200018	PLAN OF LOTS 1 & 2 Cancelling Portion 55A on Wd 1943 Lot 551	ORIG. PORTION 55A
ORIGINAL GRANT 37671		TOWN
MAP REF. Chardons Bridge	SURVEYED BY D.N. THOMPSON ...23.../NO.../88...	PARISH DARLINGTON
PROCLAIMED SURVEY AREA	SCALE 1:3000	COUNTY Ward
	REGISTERED PLAN 200018	

CROWN COPYRIGHT RESERVED, REGISTRAR OF TITLES, QUEENSLAND

WARNING - FOLDING OR MUTILATING WILL LEAD TO REJECTION - PLAN MAY BE ROLLED

4258

203179

PLAN MUST BE DRAWN WITHIN BLUE LINES

203179

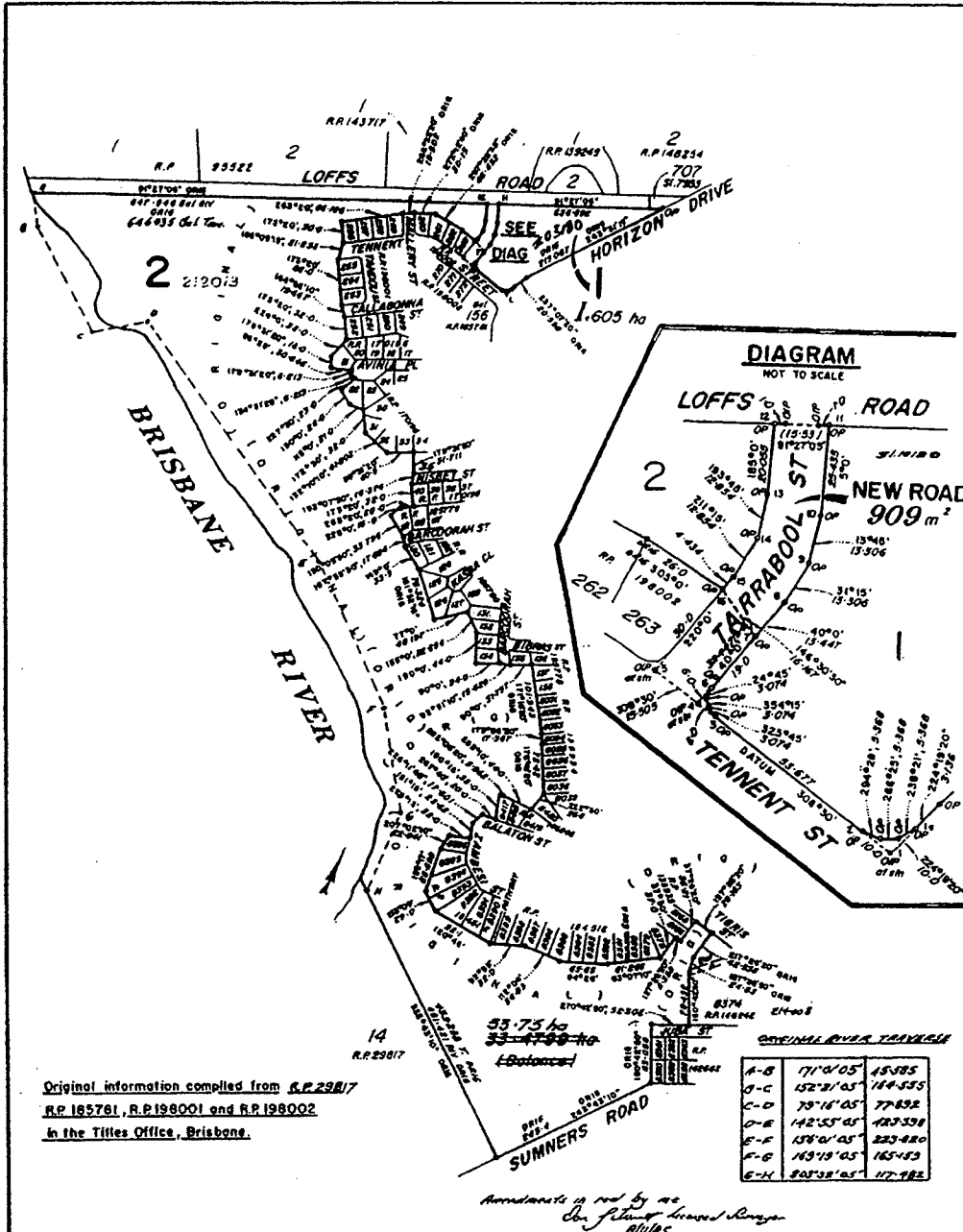

203179

PLAN MUST BE DRAWN WITHIN BLUE LINES

PLAN OF Lots 1 & 2 Cancelling Part of Lot 156 on R.P. 185761		ORIG. PORTION 345 TOWN PARISH OXLEY COUNTY Stanley
MAP REF. C.C. 161.	PROCLAIMED SURVEY AREA	SURVEYED BY O.G. TRENT ...S.I.A.R.
SCALE 1:5000		REGISTERED PLAN = 203179

CROWN COPYRIGHT RESERVED, REGISTRAR OF TITLES, QUEENSLAND

WARNING - FOLDING OR MUTILATING WILL LEAD TO REJECTION - PLAN MAY BE ROLLED

208685

208685

PLAN MUST BE DRAWN WITHIN BLUE LINES

PLAN MUST BE DRAWN WITHIN BLUE LINES

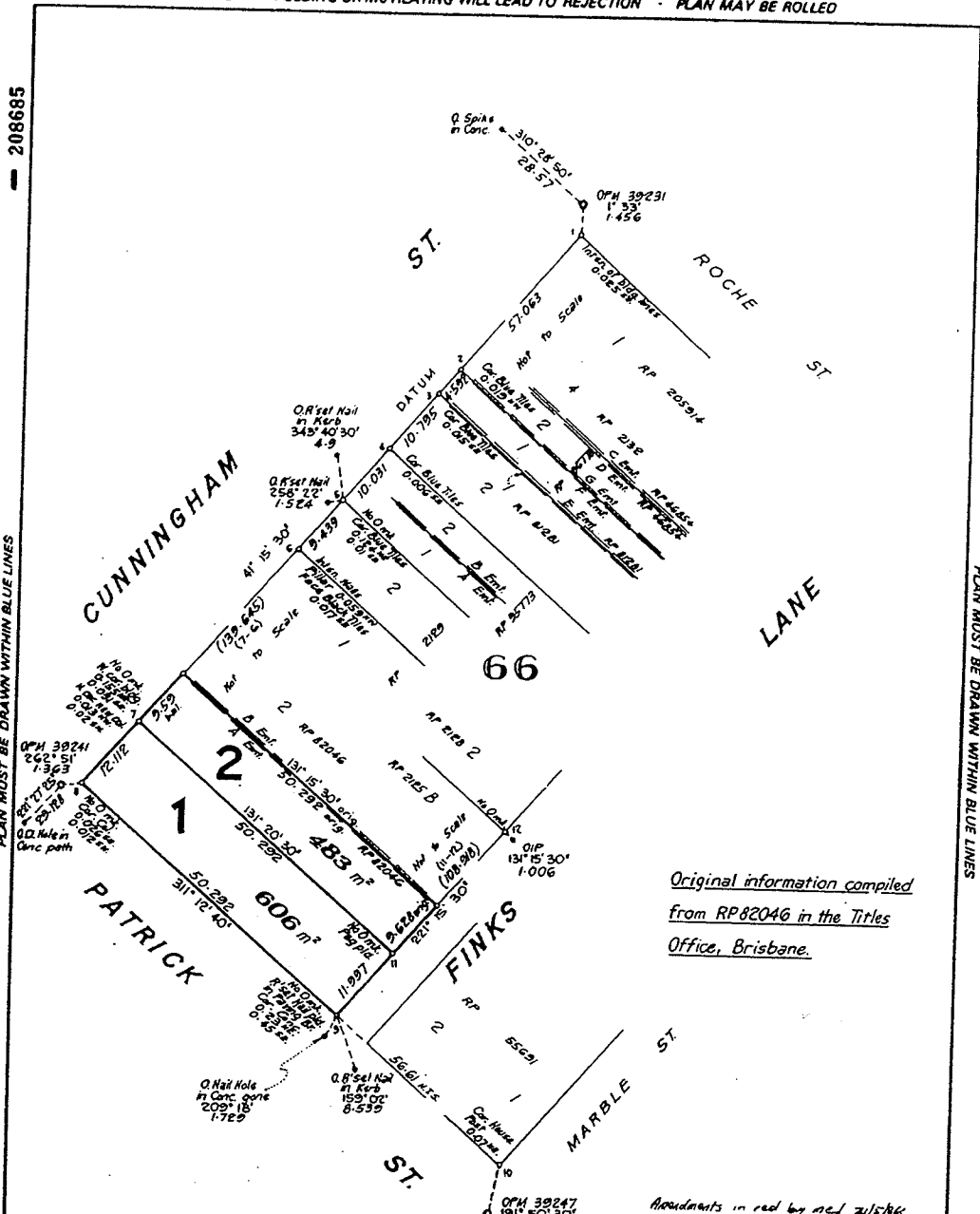

Original information compiled from RP82046 in the Titles Office, Brisbane.

Measurements in red by ref. 7/15/96. Licensed Surveyor.

.NO FIELD NOTES LOCATED		PLAN OF Lots 1 & 2 Cancelling Lot 1 on RP 200474 & ^{Sub} Resub 1 on RP 82046	ORIG. PORTION Allot. 1 of Sec. 66
ORIGINAL GRANT 5698.			TOWN DALBY
MAP REF. Dalby Str 2		PROCLAIMED SURVEY AREA	PARISH DALBY (M.F.)
SURVEYED BY S. M. Murphy PARKINSON & PARKINSON 13.1.2.1986		MERIDIAN	COUNTY Aubigny
SCALE 1:500		REGISTERED PLAN - 208685	

CROWN COPYRIGHT RESERVED, REGISTRAR OF TITLES, QUEENSLAND



GOSS



WARNING - FOLDING OR MUTILATING WILL LEAD TO REJECTION - PLAN MAY BE ROLLED

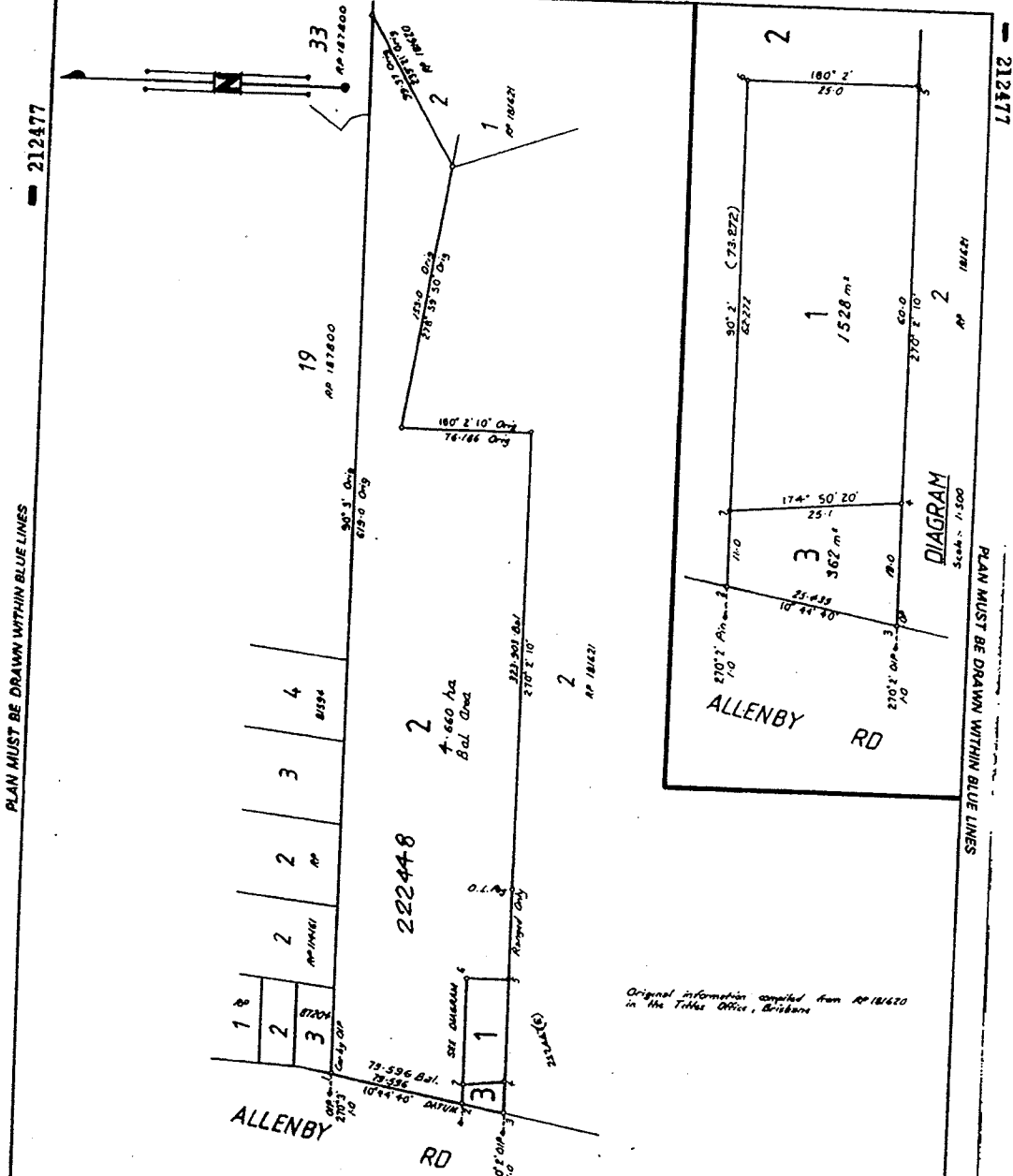

No. FIELD NOTES LOANED		PLAN OF Lots 1-3		ORIG. PORTION...19	
ORIGINAL GRANT		Cancelling Lot 1 on RP181620		TOWN	
50/103.1				PARISH...CAPALABA	
				COUNTY...Stanley	
MAP REF. 774	PROCLAIMED SURVEY AREA	SURVEYED BY RT Blain of Blain & Associates Pty Ltd	MERIDIAN	SCALE 1:1000	REGISTERED PLAN - 212477
GOVERNOR S.A.S					

CROWN COPYRIGHT RESERVED, REGISTRAR OF TITLES, QUEENSLAND



WARNING - PLAN MAY BE ROLLED - A FOLDED OR MUTILATED PLAN WILL NOT BE ACCEPTED

838974

CAMPBELL TERRACE

838974

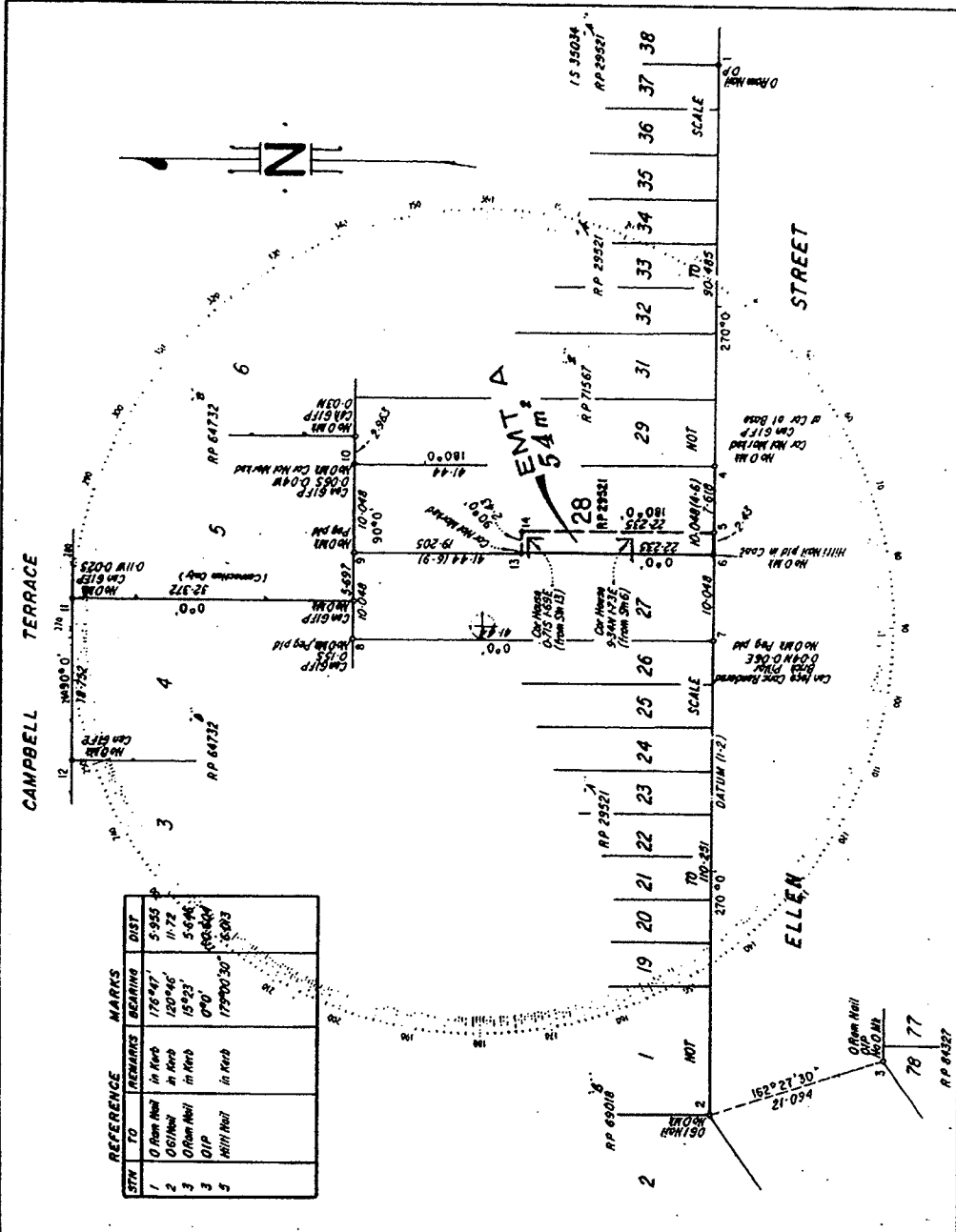

838974

PLAN MUST BE DRAWN WITHIN BLACK LINES

838974

STN	TO	REMARKS	BEARING	DIST
1	0	From Nail in Herb	120°42'	5.985
2	1	Old Nail in Herb	120°46'	11.72
3	0	Old Nail in Herb	15°23'	5.094
4	3	Old Nail in Herb	0°0'	10.864
5	1	Old Nail in Herb	179°00'30"	5.003

DEVELOPMENT SURVEY CONSULTANTS PTY LTD.
 Surveyors certify that this Company have surveyed the land contained in this plan and that the same is correct in accordance with the Surveyors Act and its Regulations and that the said survey was returned to the Registrar of Titles on the 26.6.1991.
 Licensed Surveyor
 Director
 Date 8/7/91

PLAN OF
Proposed Easement A
 in Lot 28 on RP 29521
 ORIGINAL Par 83
 NO SURVEY RECORDS DEPOSITED
 MERIDIAN MAP REF SCALE FILE REF ENDORSED REGISTERING DIST
 GCMAS 1:400 D o T

PARISH OXLEY
 COUNTY Stanley
 GOVERNMENT CITY OF BRISBANE
 LOCAL AUTHORITY BRISBANE C.C.
 LAND ACQUISITION DISTRICT BRISBANE
 MINING FIELD
REGISTERED PLAN 838974



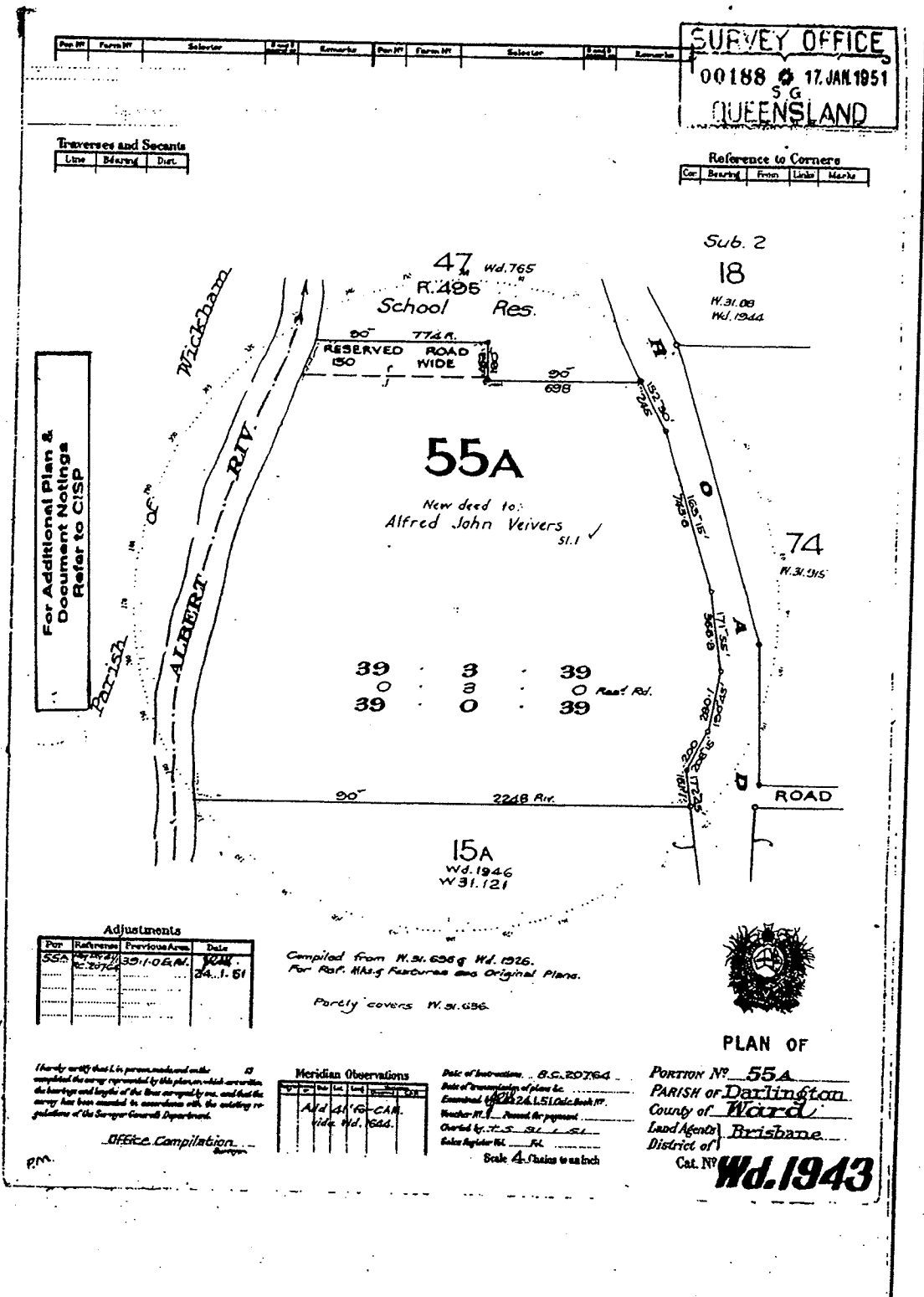

SURVEY OFFICE
 00188 17 JAN 1951
 S.G.
 QUEENSLAND

Portion	Form No.	Subsector	Area	Remarks	Portion	Form No.	Subsector	Area	Remarks

Traverses and Secants

Line	Bearing	Dist.

Reference to Corners

Cor.	Bearing	From	Links	Marks

For Additional Plan & Document Notings Refer to CISP

55A
 New deed to:
 Alfred John Veivers
 51.1 ✓

39 3 39
 0 3 0 Road Rd.
 39 0 39

Adjustments

Portion	Reference	Previous Area	Date
55A	Wd. 1943	351.06 A.	24.1.51

Compiled from N.S. 636 & Wd. 1926.
 For Port. Nos. 5 & 6 & Original Plans.
 Portion covers N.S. 636.



PLAN OF

PORTION NO. 55A
 PARISH of Darlington
 County of Ward
 Land Agents Brisbane
 District of Wd. 1943
 Cat. No.

I hereby certify that I, in person, made and under the supervision of the surveyor, which are written on the bearings and lengths of the lines surveyed by me, and that the survey has been amended in accordance with the existing regulations of the Surveyors General Department.

Office Compilation
 Surveyor

Meridian Observations

Portion	Reference	Previous Area	Date

Date of Instructions: B.S. 20764
 Date of transcription of plans &c.: 1951
 Examined by: 26.1.51 Date Book No.
 Voucher No.: Passed for payment
 Checked by: T.S. 31.1.51
 Sales Register No.: F.L.
 Scale: 4 chains to an inch

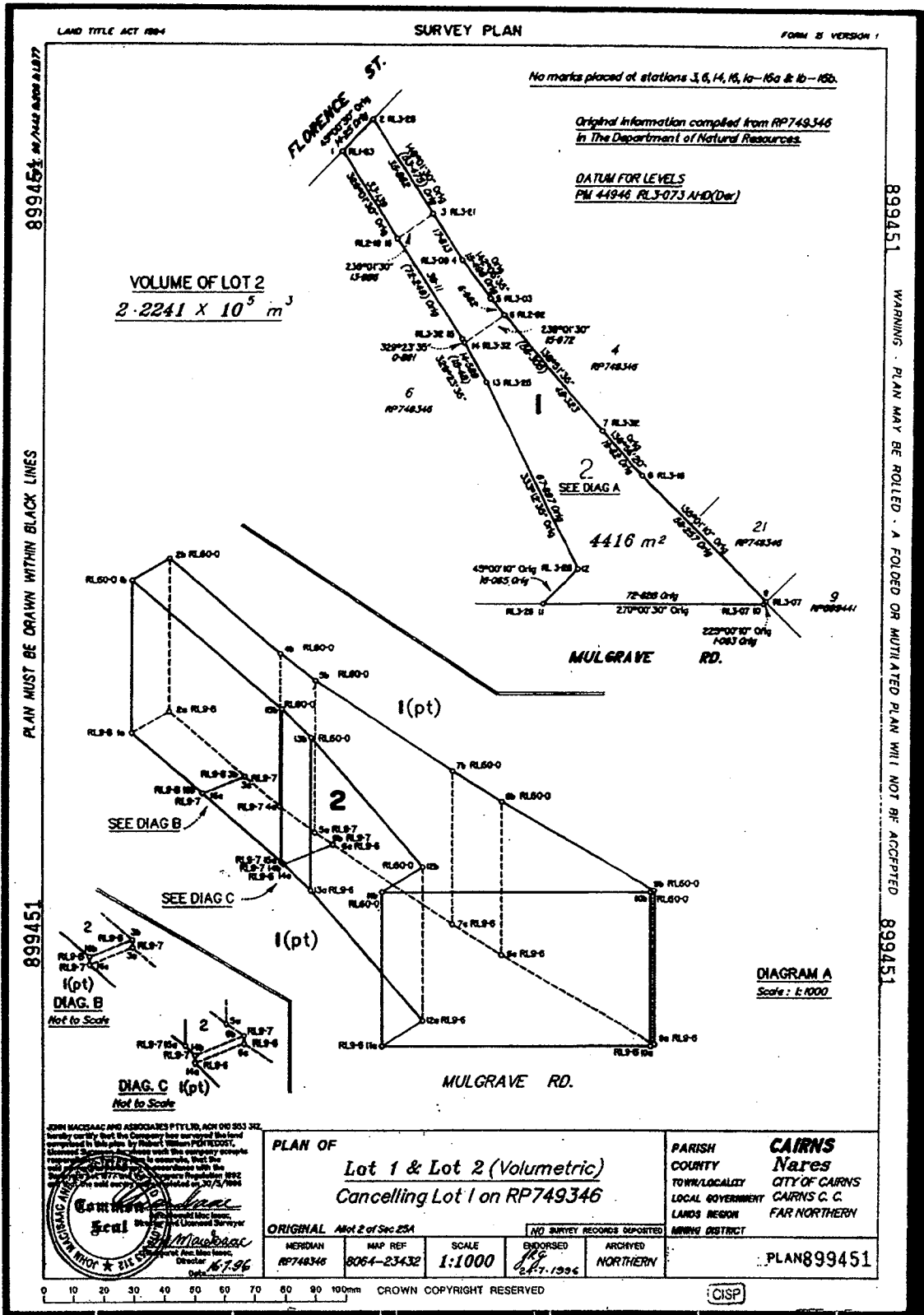

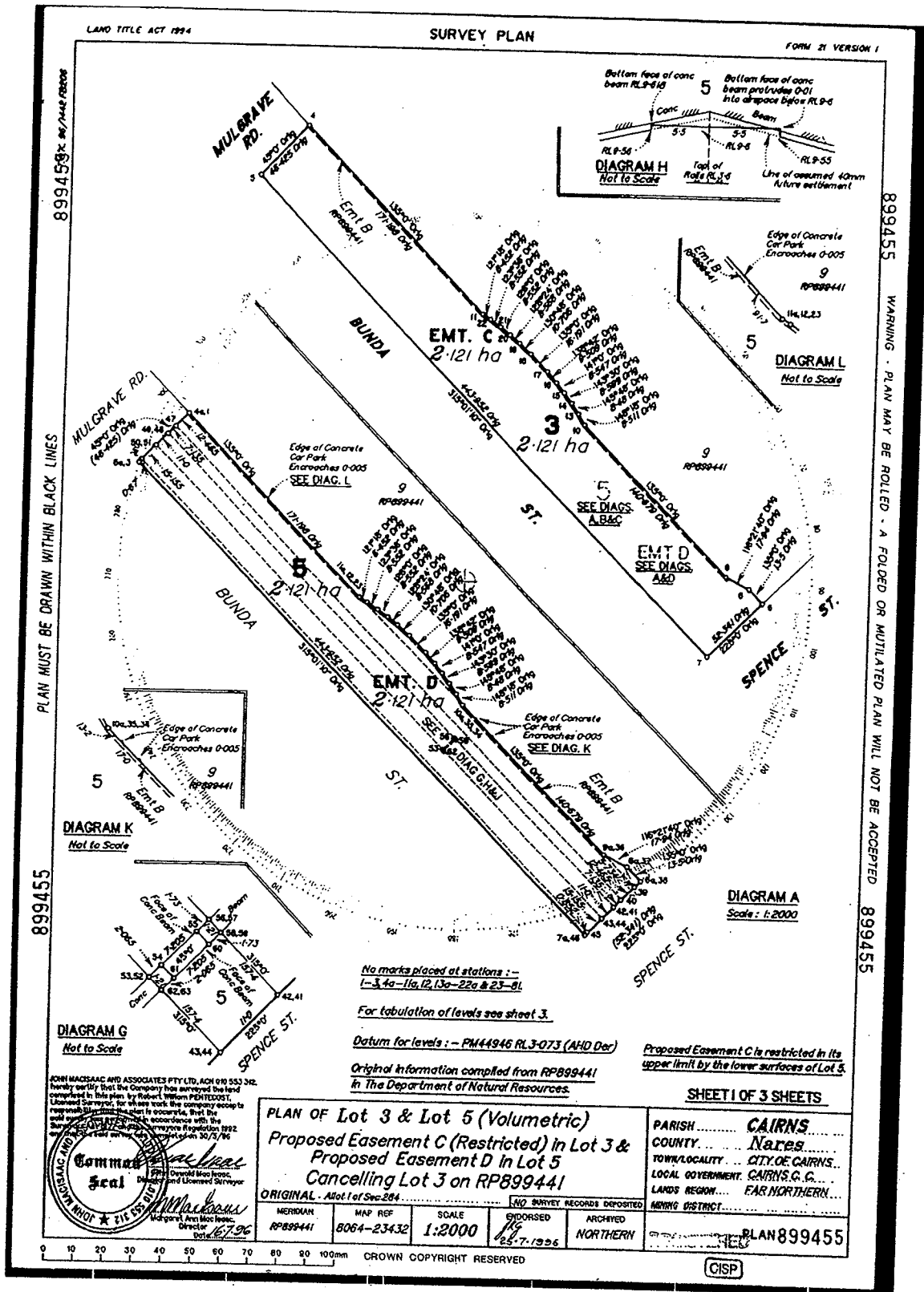

(Intentionally Blank)



REGISTRAR OF TITLES

DIRECTIONS

For the

PREPARATION OF PLANS



**QUEENSLAND
GOVERNMENT**

Land Title Act 1994

I, Loren Leader, Registrar of Titles, give these Directions under the provisions of Section 50 of the Land Title Act 1994.

A handwritten signature in cursive script that reads "Loren Leader".

Loren Leader,
Registrar of Titles.



NOTE:

These Directions are for the preparation of plans, and should be read in conjunction with other requirements necessary for registration of other relevant documentation.

This information may be found in the Land Title Act, the Body Corporate and Community Management Act, and the Regulations thereunder, and the Land Title Practice Manual.

Additional and more detailed requirements for Surveys may be found in the Survey Requirements of the Department of Natural Resources.

These Directions will be incorporated into the Land Title Practice Manual and the Surveyors Operation Manual at their next revisions.

(Intentionally Blank)

16. General:

16.1 Context of References

In these Directions, unless the context or subject matter otherwise indicates or requires:

- a reference to a section, schedule or clause of a schedule is a reference to a section, schedule or clause of the Land Title Act 1994, or the Land Title Regulation 1997.
- a reference to a Form is a reference to a Form approved for a purpose under section 194(1) of the Act.

16.2 Compliance with other legislation:

Plans shall comply with the general requirements, where applicable, of the:

- Body Corporate and Community Management Act, 1997
- Land Title Act, 1994;
- Land Act, 1994;
- Local Government (Planning and Environment) Act, 1990;
- Surveyors Act, 1977 and the Surveyors Regulation, 1992;
- Survey Co-ordination Act, 1952; and
- where applicable, in the case of a plan prepared under the provisions of Specified Acts, the Building Units and Group Titles Act, 1980, and the Regulations thereunder. (See Direction 3.5).
- established practice as formulated from time to time in the Survey Requirements of the Department and these Directions.

16.3 Unusual Cases:

While these Directions lay out specifications for dealing with surveys and plans, it should be understood that they are not inflexible, and given sufficient reason, they may be varied in special cases. Where such a variation is permitted, it may not be taken as a precedent for any cases that may follow at a later date.

Surveyors are encouraged to discuss these cases with the Department at an early stage in the development process so that delays in registration may be minimised.

(Intentionally Blank)

17. Definitions:

Base Parcel: The lot or lots that are subdivided by a plan.

Bounding surface: means the limiting feature of a volumetric parcel. This may be a plane or any surface that can be mathematically generated and sufficiently defined and shown on a plan such that there is no possibility of ambiguity.

Building: when applied to a parcel indicates that that parcel is generally defined by floors, walls and ceilings.

Delineate: means to show the extent of a lot or common property by a line diagram on a building format plan, drawn to scale, and to provide an approximate area for each lot in accordance with these Directions.

Dimension: means to place bearings and distances on the boundaries of a parcel, in accordance with the requirements of the Surveyor's Act 1977, the Surveyors Regulation 1992 and any Directions made by the Registrar.

Footprint:

- means the vertical projection of the outermost bounds of a volumetric parcel onto a horizontal plane approximately at ground level.
- An overall footprint means the vertical projection of the outermost bounds of a volumetric parcel, regardless of any internal division into parts, onto a horizontal plane approximately at ground level.

Parcel: means a lot, part lot, easement, lease, common property, or exclusive use area.

Remainder: when applied to a lot indicates that that lot is the remainder of a standard lot after a volumetric lot has been subdivided out of it.

Restricted:

- when applied to an easement indicates that that easement is restricted in either height and/or depth by a horizontal plane or planes.
- When applied to a lot indicates that that lot is restricted in height or depth by a defined distance below the surface. (See Directions 23.5 and 25.2.3).

Standard: when applied to a parcel indicates that that parcel is unlimited in height and depth.

Volumetric: when applied to a parcel indicates that that parcel is fully limited by bounding surfaces.

Unless specifically directed by these Directions, parcels are not to be qualified on any plan or document by the adjectives "Building", "Remainder", "Restricted", "Standard" or "Volumetric".

(Intentionally Blank)

18. Plan Forms:

18.1 Approved forms:

Plans and additional sheets to plans must be in the approved Form, Form 21 Version 2 and Form 21A Version 1 respectively, comply with Regulation 4.(3) and:

- be international A3 size;
- be white and free from discolouration and blemishes;
- be printed on material that complies with Direction 18.2;
- have clear margins no smaller than 10 mm on all sides, and printing, writing or drawing, shall not extend into any margin;
- have information, signatures and seals added in a manner that is permanent and can be imaged by mechanical or digital processes to produce a copy satisfactory to the Registrar.
- be flat or rolled, and not having been folded.

18.2 Material Specifications for Plan Forms:

The material used for each plan form shall comply with the following:

- **Weight:** Minimum of 130gsm, and with sufficient rigidity that it can be readily distinguished from photocopy paper;
- **Colour:** White;
- **Opacity:** Must be such that there is no "print through" when the reverse side is imaged;
- **Surface:** Must be such that it will take a permanent image. For the Form 21, this requirement applies also to the reverse side of the form;
- **Archival Properties:** Minimal;

The same material must be used for all sheets within the one plan.

Surveyors are advised that:

- amendments to plans may be required following lodgement. These must be effected by strike out and/or addition by hand. (See Direction 19.16). The surface must be capable of accepting these amendments;
- if a plan is presented for lodgement with multiple amendments by strike out and additions, it may not be accepted.

18.3 Digital Plan Forms:

The Registrar may make available an approved form in digital format to persons wishing to use that form.

Where plans are drawn from a digital format, the form or forms produced shall comply as closely as possible with the approved format, and any differences occurring due to the use of different software packages should be minimised as far as possible.

18.4 Transition provisions for plans:

18.4.1 Plans for Community Titles Schemes:

The transition period set in Section 273 of the Body Corporate and Community Titles Act, shall be observed.

18.4.2 Other Plans:

The Mandatory Date for the use of Form 21, Version 2 and Form 21A, Version 1, shall be set at a date two months following the date of commencement of the Body Corporate and Community Management Act.

All plans signed by the licensed surveyor following the Mandatory Date must be drawn on Form 21, Version 2, and, if necessary, on Form 21A, Version 1.

During the transition period up to the mandatory date, Form 21 Version 1 may be used in lieu of Form 21 Version 2 and Form 21A Version 1, provided that any additional information required to be shown on Form 21 Version 2 is shown on the Form 21 Version 1.

18.5 Building Units and Group Titles Act 1980 in conjunction with Specified Acts:

A Specified Act is as defined in Section 271 of the Body Corporate and Community Titles Act.

Where it is desired to lodge a Building Units or Group Titles plan under the provisions of a Specified Act, the Building Units and Group Titles Act, 1980 and the Regulations thereunder remain in force and shall define the requirements of plans.

In particular, the plan forms specified in the Building Units and Group Titles Regulations, 1980, must continue to be used.

19. Plans for registration:

19.1 Forms to be used:

Every plan shall consist of a Form 21, Version 2, the main plan, being sheet 1. If the space available on the main plan is insufficient in any case, additional sheets of Form 21A Version 1, the additional sheet, may be added.

19.2 Plan Numbering:

Each plan shall be numbered:

- ◆ by obtaining a barcoded label from the Department; and
- ◆ in the case of the main plan:
 - the number only from the barcoded label shall be placed in the space provided on the face of the main plan in a prominent font;
 - the barcoded label shall be affixed in the space provided on the face of the main plan. (This will cover the number placed in the preceding Direction, but will allow for the possibility that the label may be removed); and
 - the number only (but including the prefix) from the barcoded label shall be placed in the space provided on the reverse of the main plan;
- ◆ in the case of an additional sheet or sheets, the number only (but including the prefix) from the barcoded label to be affixed to the main plan shall be placed in the space provided on each additional sheet.

As the Department's imaging system requires that the longer side of the barcoded label be parallel to the bottom margin of the plan form, care should be taken when it is being affixed. Plans may be refused if the label is not fixed exactly within the space provided.

19.3 Sheet numbering:

Each sheet contained in the plan shall be numbered consecutively in the top right hand corner commencing with 1 on the main plan, and each sheet shall show the total number of sheets. The reverse of the main plan is not to be considered a separate sheet, and does not receive a number in the sheet numbering series.

19.4 Plan with only one sheet:

Where Standard and Volumetric Format plans do not include any additional sheets they shall show to scale:

- the total extent of the land being dealt with; and
- all parcels created on the plan;

together with reference to any diagrams that may be necessary to clarify any detail, and shall be complete within the main plan.

In the case of a Building Format plan, the main part of the plan shall show to scale the information required by Directions 24.8 and 24.9, with separate diagrams being used for each level diagram.

19.5 Plan with Additional Sheets:

Where Standard and Volumetric Format plans include, in addition to the main plan, one or more additional sheets, the main plan shall show to scale:

- the total extent of the land being dealt with; and
- all parcels created on the plan;

In the case of a Building Format plan, the main plan shall show to scale, as far as possible, the information required by Directions 24.8 and 24.9.

The main plan, for all format plans, shall show, in addition, references to any diagrams that may be necessary to clarify any detail, and which may appear elsewhere on the main plan or on any additional sheets.

Additional sheets shall be completed on one side only and shall not contain any information or diagrams on their reverse side.

19.6 Additional requirements for Volumetric Format Plans:

In the case of a Volumetric Format plan, the main plan shall show, in addition to the requirements of Directions 19.4 and 19.5:

- the footprint, or footprints, drawn to scale, of any volumetric parcels being created on the plan, together with an area for the footprint. Where a parcel is in parts, as permitted or required by Direction 23.4, it is necessary to show only the overall footprint and area as required by that Direction, together with references to the sheet or sheets on which full details of the footprints of the parts of the parcels may be found.
- the whole of any volumetric parcel or parcels, drawn to scale, being created on the plan. Where a parcel is in parts, it is necessary only to show the whole parcel, together with references to the sheet or sheets on which full details of the diagrams of the parcels may be found.

19.7 Format to be noted:

The Format of the plan shall be noted in the "Format" field on the face of the plan.

19.8 Lots to be described:

Lots shall be described as required by Section 50(a), Section 50(c) and/or 50(d) of the Land Title Act. Saving that where a parcel is common property, it may be described appropriately.

Where land is to be Public Use Land, the plan shall show within the lot on the face "Public Use Land - <purpose>", with the purpose being a public purpose within the meaning of Schedule 1, "Community Purposes", of the Land Act 1994. Where space is restricted, it is acceptable to omit "Public Use Land", and only show the purpose.

19.9 Plan Description and Cancelling Clause:

Each plan shall contain in the space provided, on the face of the main plan, a description of the parcels being created, and, where existing lots or Unallocated State Land are being cancelled, a cancelling clause listing those lots and their plan numbers.

19.10 Surveyors Certificate:

The surveyor shall add to the main plan, in the space provided in the bottom left hand corner of the face, the licensed surveyors certificate specified by the Surveyors Regulation 1992.

19.11 North Point:

North shall be noted on all plans by means of a protractor or by a North Point.

19.11.1 Protractor:

A protractor may be added to a plan and any additional sheets, and the north point on the protractor shall be vertical, that is, it shall indicate directly to the top of the plan form.

19.11.2 Protractor omitted:

Where the location of North is not otherwise noted by a protractor, the face of the main plan, and any additional sheets, shall bear a north point.

19.11.3 Scales:

Other than as permitted below, each sheet of the plan shall show:

- the scale used; and
- a bar scale at least 150 millimetres in length, showing distances at the scale of the plan.

This may be in addition to, or in lieu of, the ruler shown on the face of the main plan and on each additional sheet. Where a bar scale is provided in addition to the ruler, it shall be located immediately above the ruler.

Where a diagram is used, the scale used in preparing that diagram shall be shown, or the notation "not to scale".

Where an additional sheet consists wholly of diagrams at different scales, the bar scale may be omitted. However, in this case the ruler must remain.

19.11.4 North may be rotated:

North may be other than vertical on the page, but it must be rotated no more than 90 degrees from the vertical and be clearly noted with a North Point. This Direction does not permit a protractor to indicate north other than as noted in Direction 19.11.1.

19.12 Allocation Tables:

Allocation tables shall be provided on the reverse of the main plan for the following:

- ◆ Where there is more than one original lot in the base parcel, allocate the new lots, easements and road to the original lots;
- ◆ Where there is more than one original portion and more than one new lot being created on the plan, allocate the new lots to the original portions;
- ◆ Where any registered interest affects only part of the base parcel, allocate that interest to the new lots, either fully or partially.

19.13 Name and CMS of Community Titles Scheme:

Where the plan creates common property, or deals with lots that are intended to be the subject of a Community Management Statement, the Name of the Community Titles Scheme shall be noted in the space provided on the reverse of the main plan. In addition, where land already contained within a Community Titles Scheme is subdivided, the CMS number of the Community Management Statement assigned by the Registrar to that Community Titles Scheme shall also be noted.

19.14 Plans may be compiled:

In these Directions, where it is directed that:

- the whole of a base parcel shall be dealt with, leaving no undescribed balances; or
- each parcel shall be surveyed and marked;

it is acceptable for the parcel or parcels to be compiled in accordance with Section 25 of the Surveyors Regulation if that is appropriate.

19.15 Volumetric lot as adjoining information:

Where a lot that is affected by a volumetric lot (i.e., a volumetric lot above or below the surface of that lot, or partly above and partly below the surface) is being dealt with on a subsequent plan:

- the footprint of the volumetric lot shall be shown in broken line on the main plan; and
- the footprint shall be referenced by lot and plan number, and the notation "Volumetric".

It is not required that the actual volumetric lot be shown as an isometric diagram.

19.16 Amendments to plans:

19.16.1 After Lodgement, prior to registration:

Following lodgement but prior to registration of the plan, alterations and additions must be in black ink and must be effected by strike out and addition.

Amendments made under the provisions of Section 155(1) of the Land Title Act may only be effected by a person holding a delegation from the Registrar to make such corrections.

All other amendments must be made by the licenced surveyor and a certificate of amendment, signed and dated by the licensed surveyor in black ink, must be added to the face of the plan.

19.16.2 After Registration:

Corrections to registered plans are effected under the provisions of Section 15 of the Land Title Act and Section 291 of the Land Act 1994, and may only be effected within the Department.

Corrections following registration, either by alteration or addition, may only be made:

- following the lodgement of a Form 14, General Request, requesting such corrections. The Form 14 must be accompanied by a Statutory Declaration from the licensed surveyor as to the correction to be made;
- by a person holding a delegation from the Registrar to make such corrections; and
- in a colour other than black ink that is suitable for reproduction through the scanning and photocopying processes.

20. Sketch Plans:

This Direction applies to sketch plans being prepared under the provisions of the Land Title and Body Corporate and Community Titles Acts.

20.1 Sketch Plans permitted:

Sketch plans are permitted to be used in the following cases:

- Plans of leased areas;
- Plans of profit à prendre areas;
- Plans of exclusive use areas in Community Titles Schemes;
- In other cases with the prior approval of the Registrar.

20.2 Standards:

Sketch plans shall be drawn to the following standards:

20.2.1 All Sketch Plans:

All sketch plans shall:

- ◆ be drawn on A4 or A3 sized paper, unless prior permission has been sought from the Registrar in cases where these sizes are impractical;
- ◆ be drawn to scale. (See Direction 20.2.9);
- ◆ generally be drawn with north indicating vertically, but may be rotated no more than 90 degrees clockwise from the vertical;
- ◆ show a north point;
- ◆ show:
 - in the case of an exclusive use area, the Community Titles Scheme name;
 - in all other cases, the title reference and description of the lot.
- ◆ clearly designate the areas being defined by:
 - outlining the parcel by a line which is significantly heavier than other lines on the plan;
 - by clearly designating the parcels by an identifier; and
 - optionally in the case of leases, by designating the leased area by hachuring. Where hachuring is used, this should not obliterate any information.
- ◆ show an area for the defined parcel;
- ◆ clearly indicate the purpose of the plan.

20.2.2 Sketch Plans within a building:

In addition to the requirements on Direction 20.2.1, a sketch plan shall:

- ◆ show sufficient dimensions, in metres, to calculate the area of the defined parcel and to locate it within the building, other than for exclusive use areas fully defined by structural elements within common property created on a Building Format plan;
- ◆ show the position of the building on the lot and a connection from the corner of the building to an intersection of the title boundaries if:
 - the sketch is being prepared for purposes other than an exclusive use area in a Community Titles Scheme;
 - there is more than one building on the land; or
 - alterations/additions have been made to an existing building(s), the subject of current registered leases; or
 - the building is erected on and in two or more lots; or
 - the premises are in a complex such as a large shopping centre.
- ◆ where the sketch is being prepared for an exclusive use area, and there is more than one structure on the base parcel, the designation of the building (see Direction 24.11) and the floor level (see Direction 24.12) shall be noted;
- ◆ clearly define the area being dealt with:
 - in the case of an exclusive use area by showing sufficient connections to defined structural elements on the level to clearly locate the area; and
 - in the other cases, by showing the layout of the parts of the floors being leased, showing the limiting walls in relation to the external walls of the building;

It should be noted that architectural or building plans are not acceptable.

20.2.3 Sketch Plans outside a building (part of the land):

In addition to the requirements on Direction 20.2.1, a sketch plan shall show:

- ◆ distances in metres and bearings;
- ◆ at least two connections to intersections of title boundaries.

Where a parcel being defined is restricted in either height or depth or both, the requirements of Direction 25.7 shall apply.

20.2.4 Sketch Plans by Licensed Surveyor:

A Licensed Surveyor must prepare and certify sketch plans that deal with:

- ◆ all defined parcels outside buildings, or of part of the land;
- ◆ a lease of part of a building which is
 - high value; and/or
 - long term (over five years, including options to renew).

Where the defined area is outside a building or of part of the land the surveyor shall affix the Form 13 specified in the Surveyors Regulation 1992.

In other cases, the surveyor shall use the following certificate:

I, _____, Licensed Surveyor, certify that the details shown on this sketch plan are correct.

Licensed Surveyor,

Date.

20.2.5 Sketch Plans by other than a Licensed Surveyor:

Sketch plans may be prepared by persons other than a licensed surveyor where:

- ◆ an exclusive use area is within a building or structure;
- ◆ a lease is within a building and is both:
 - low value; and
 - short term (five years or less, including options to renew).

20.2.6 Leased Areas over multiple lots:

Where a plan of a leased area covers more than one lot, an allocation table shall be prepared showing the area of the lease in each of the lots in the base parcel.

20.2.7 Multiple sheets:

Where a single sheet is insufficient to show the required information, multiple sheets may be used. In using multiple sheets:

- They shall be international A3 size and drawn on one side only;
- The first sheet shall show, to scale, the whole of the parcels or parcels, together with reference to any diagrams that may be necessary to show the parcels in detail;
- Each sheet contained in the plan shall be numbered consecutively in the top right hand corner commencing with 1 on the first sheet, and each sheet shall show the total number of sheets.

20.2.8 Value:

Where the terms "high value" and "low value" are referred to in these Directions, the value to be used in the determination of high or low shall be determined from time to time by the Registrar.

20.2.9 Scales:

Plans shall be drawn accurately to a scale and shall show all areas being described on the plan in one diagram. Additional diagrams may be used to illustrate detail.

Each plan shall show the scale used, and a bar scale at least 100 millimetres in length, showing distances at the scale of the plan.

20.2.10 Scale Ratios:

Scale ratios, or multiples thereof, which may be used in sketch plans:

- | | | | | |
|-------|----------|---------|-------|---------|
| 1 : 1 | 1 : 1.25 | 1 : 1.5 | 1 : 2 | 1 : 2.5 |
| 1 : 3 | 1 : 4 | 1 : 5 | 1 : 6 | 1 : 7.5 |
| 1 : 8 | | | | |

21. Easements:

21.1 Compliance with Land Title Act:

Plan delineating easements in freehold land must comply with Subdivisions A or B of Division 4 of the Land Title Act.

Where it is desired to effect a subdivision and define easements that do not comply with Section 96 of the Act, it will be necessary to prepare separate plans for the subdivision and the easements.

21.2 Fully Dimensioned:

Easements shall be fully dimensioned and given an area, and be defined on a plan of the appropriate format.

21.3 Easements in parts:

Easements may not be in parts other than as permitted in Direction 23.4.

21.4 Unrestricted Easements:

Where an easement is to be unrestricted vertically, it shall be defined on a Standard Format plan, or, where applicable, may be defined on a Building Format plan provided that the easement is not contained within any structure defined as a building on that plan.

21.5 Restricted Easements:

Where an easement is to be restricted vertically, it shall be restricted in both height and depth and defined as a volumetric easement on a volumetric format plan in accordance with the requirements of Direction 25.

However, where an easement is restricted by horizontal planes in either height or depth or both:

- it may be defined on either a Standard Format plan, or, where applicable, may be defined on a Building Format plan;
- the description shall include the word "Restricted"; and
- the vertical restriction shall be detailed on the plan with reference to the Australian Height Datum, together with details of the Permanent Mark on which this is based.

However, the provisions of Direction 25.10.6 may be utilised if levels on the Australian Height Datum are not available in the immediate area of the survey.

21.6 Easement occupying the whole vertical extent of a lot:

An easement occupying the whole of the vertical extent of a lot, including restricted, building and volumetric lots, is not considered to be restricted.

21.7 Easement as adjoining information:

Where an easement has been registered:

- the easement shall be plotted on the face of the plan; or

- in the case of a volumetric easement, the footprint shall be plotted on the face of the plan;
and
- the easement referenced by easement letter and plan number.

22. Plan Formats:

- **Standard Format Plans** create parcels that are of two dimensions at ground level, and unlimited in height and depth. They are defined by surveyed dimensions and marks placed on the ground.
- **Building Format Plans** create parcels within structures. They are defined and limited by floors, walls and ceilings, other than in special cases noted in Direction 24.18
- **Volumetric Format Plans** create parcels that are fully enclosed by bounding surfaces. They may be above or below, or partly above and partly below, ground surface and are defined by surveyed dimensions and levels.

It is not permissible to create parcels of different format types on the same plan, other than in the case of easements and the remainder lot on a volumetric format plan. (See Directions 21 and 25.2.4).

Plans of all formats may cancel a base parcel containing multiple lots of the same format. (However see Directions 24.16 and 24.29.4). That is, there is no requirement to amalgamate a number of lots prior to a survey of land for a Community Titles Scheme.

Each of these formats uses the same plan forms, but the requirements for presentation differ depending on the format. These requirements are detailed in Directions 23, 24 and 25.

(Intentionally Blank)

23. Standard Format Plans:

23.1 Subdivision:

A Standard Format plan may subdivide:

- a lot or lots and/or common property created on a Standard Format plan;
- that part of common property created on a Building Format plan, which is located outside the building;
- the remainder lot or lots that are described on a volumetric format plan.

The whole of the base parcel being subdivided must be dealt with, and no undescribed balance or remainder shall be left. (See also Direction 19.14).

23.2 To be surveyed and marked:

Each parcel, including any balance lots, shall be surveyed, and marked in accordance with the Surveyors Act 1977 and the Surveyors Regulation 1992, given an area and dimensioned in accordance with these Directions. (See also Direction 19.14).

23.3 Lot Numbers:

Lot numbers on a Standard Format plan shall be numeric and numbered as close to consecutively as is reasonably possible.

In the case of a lot that is proposed for public use land, access restriction strips and similar purposes or a large lot that is proposed for future subdivision, it may be given a number that is higher than the total number of lots within the development.

In the case of a staged development, provided that the numbering of lots in the completed development complies with the preceding paragraph, the numbering of lots on individual plans of stages in that development need not.

23.4 Part Lots:

Part lots are permitted, but parts of the same lot shall not immediately adjoin one to the other.

23.4.1 Part lots separated by lots:

Where part lots are separated by lots, other than lots specified in Direction 23.4.2, each part shall be noted with its lot number and the designation "Part" or "Pt" and given an area. A total area shall be noted on the largest part or, if insufficient space, may be noted on the face of the plan.

23.4.2 Other Cases:

Where part lots are separated by:

- a watercourse;
- a road;
- a railway;

- a stock route;
- a channel or drain;
- a reserve;
- any other Transport Infrastructure corridor; or
- any combination of the above features;

a vincula may be used to bind several parts of the same lot.

Where vincula are used, a total net area shall be shown without showing separate areas for each individual part.

23.5 Lots or leases with restrictions in height and or depth:

A lot or lease that has any restriction in height and or depth may not be defined on a Standard Format Plan, other than in the case of an existing lot the vertical limit of which is defined with reference to the surface, or as provided for in Direction 23.1.

23.6 Easements with restrictions in height or depth:

Easements with restrictions in depth may be defined on a Standard Format plan, subject to the requirements of Direction 21.5.

23.7 Lots with existing restriction “relative to the surface of the land”:

Where a plan deals with existing lots that are restricted to a distance “relative to the surface of the land”:

- the main plan shall bear a prominent note, located immediately above the title block, detailing the restriction and the lots affected; and
- the description shall refer to the lot or lots as “Restricted”, ie Lot 1 (Restricted).

24. Building Format Plans:

24.1 Definitions for Building Format Plans:

For this section, the following definitions shall apply:

Balcony: means a part of a lot being an addition to the face of a building, whether covered or uncovered, that immediately adjoins its parent lot, is accessible from that lot and is above ground level. (See Direction 24.19).

Carport: means a lot or part of a lot for parking contained within an open structure that consists only of roof and floor. (See Direction 24.20).

Courtyard: means a part of a lot being an enclosed area, paved and usually at ground level, and which immediately adjoins another part or parts of the same lot and usually no greater in area than that lot. The feature enclosing a courtyard need not be a wall, but shall be sufficient to clearly define the area. (See Direction 24.21).

Existing Building: means a building which was completed before the commencement of the Body Corporate and Community Management Act.

Garage: means a lot or part of a lot being an area for parking contained within an enclosed structure or on an unroofed level of a building. (See Direction 24.22).

Private Yard: means a part of a lot being generally an unroofed area, unlimited in height and depth, being open space at ground level and which immediately adjoins another part or parts of the same lot. (See Direction 24.23).

Roof Garden: means a part of a lot being an area on the roof of a building, other part or parts of which are contained within the same building. (See Direction 24.24).

Verandah: means a part of a lot being an area within the same structure as another part of the same lot, immediately adjoining that part and which is defined by floors and ceilings, and partly by walls and partly by balustrades. (See Direction 24.25).

Void: means an area that is not included in the definition of a part lot, of which other parts are defined on several different levels and which are immediately one above the other.

Where it is desired to use terms to describe other areas that may be required to describe certain areas on a plan, prior approval of the Registrar must be sought for their use.

24.2 Subdivision:

A Building Format plan may subdivide:

- a lot or lots and/or common property created on a Standard Format plan;
- a lot or lots and/or common property created on another Building Format plan;
- a lot or lots and/or common property created on a Volumetric Format plan.

Other than as permitted in Direction 24.29.4, it is not permissible to subdivide a base parcel that consists of both standard and volumetric lots.

The whole of the base parcel being subdivided must be dealt with, and no undescribed balance or remainder shall be left. (See also Direction 19.14 and 24.3.2).

24.3 Lots on a Building Format Plan:

24.3.1 Creation of Building Format Lots:

A Building Format plan:

- must create common property; and
- must create at least two lots;

unless the plan is a resubdivision of an existing lot, or an amalgamation of existing lots, in a Building format plan.

Provided that the foregoing is complied with, it is acceptable for a Building Format plan to create individual isolated lots within a Scheme.

All lots, or parts of lots, must be contained within, on, under or attached to a building or structure except as permitted under Directions 24.21 and 24.23.

24.3.2 Creation of a Standard Format Lot:

Where a Building Format plan deals with part of a base parcel that consists of Standard Format lots only, the remainder of the base parcel shall be fully dimensioned, given a number and shall be considered to be a Standard Format lot for any future action. (See also Direction 4.14. (19.14)).

A note shall be placed on the face of the main plan stating that Lot <lot number> is a Standard Format lot.

24.4 Lot Numbers:

Lot numbers in a building format plan:

- shall be numeric;
- shall be numbered consecutively, saving that where a numbering system based on numbers in a level is adopted, numbers need not be consecutive from one level to the other;
- must not be duplicated within the one plan;

24.5 Part Lots:

Part lots are permitted.

Each part shall:

- where it is separated from another part of the same lot, be noted with its lot number and the designation "Part" or "Pt"; and
- be given an area.

A total area shall be noted on the largest part or, if insufficient space, may be noted on the face of the plan.

Where part lots are located on different levels, provided that the main part of the lot complies with the requirements of Direction 23.3, other parts of the same lot may appear in any order in relation to other lots or part lots.

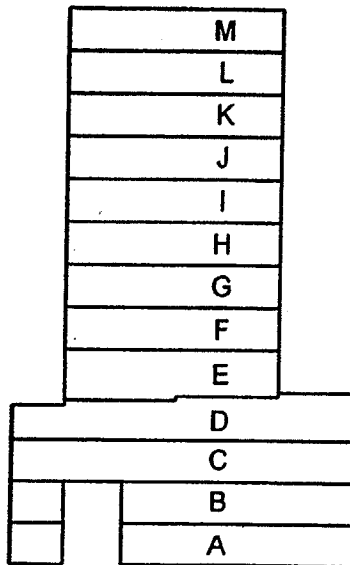

Figure 24.2: Lateral Aspect View

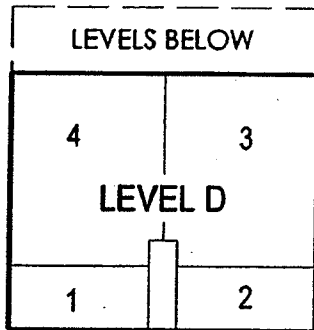

Figure 24.3: Level D, illustrating the location of a level below

24.10 Information to go on the main plan:

The information required in Directions 24.8 and 24.9 shall, as far as possible, be shown on the face of the main plan.

24.11 Multiple buildings:

Where there are multiple buildings or structures within the one plan, each building or structure that contains more than one lot shall be lettered sequentially, and prefixed with the word "Building" or "Bldg".

Where the plan is the first in a Community Titles Scheme, the commencing letter shall be A. Subsequent plans in the same Community Titles Scheme may start with the next letter.

24.12 Multiple levels:

Where there are multiple levels in a building, each level shall be lettered sequentially, commencing with the letter A, which shall designate the lowest level in the building.

In the case of multiple buildings, each level in each building shall be designated using the same system, regardless of the relative relationship in height between levels lettered the same in each building.

Where a lot occupies several levels, the part on each level shall be shown as a separate part lot.

24.13 Level Diagrams:

Details of the lots on each level in each building shall be illustrated in a separate diagram. These diagrams shall be drawn to the same scale, which shall be such that the required information may be clearly shown. (See Direction 24.27)

24.14 Buildings with levels of different horizontal dimensions:

- Where a building is of differing horizontal dimensions on different levels, on the outline diagram for a level that is set back from the level below, the outer limits of the lower level shall be shown in broken line.
- Where necessary, a diagram or diagrams showing the lateral aspect (vertical section) shall be included in the plan. It will be acceptable, and may be necessary, to show the lateral aspect from different viewpoints.

See Figure 24.2 and Figure 24.3.

24.15 Floors with steps in level:

A step in physical level on a floor shall not necessitate creation of another level merely because of this step in physical levels, regardless of the amount of the step.

Where the amount of the step is greater than one metre, a lateral aspect view shall be provided showing the step in-relation to the remainder of the building.

- the footprint of the volumetric lot as part of the main diagram of the base parcel. The footprint area shall be shown as a note immediately under the note of the total area required by Direction 24.8. This note shall be repeated under any Direction that requires an amended total area to be shown.
- show an isometric diagram of the volumetric lot;

24.16.3 Lateral Aspect Diagram:

A lateral aspect diagram shall be prepared showing the relationship of the floor levels in the plan to the volumetric lot.

24.16.4 Level Diagrams:

On the diagram of any level that:

- fully adjoins any part of the volumetric lot in the vertical dimension, indicate the extent of that lot in full line;
- partially adjoins any part of the volumetric lot in the vertical dimension, indicate the extent of that lot in broken line.

24.16.5 Boundary between Standard and Volumetric lots:

In all other respects, it is not necessary to indicate the dividing line between the volumetric and standard format lots.

24.17 Boundaries of lots:

A lot, or part of a lot adjoining other lots and/or common property and within a structure, shall be bounded by the centre of floors, walls and ceilings, unless otherwise permitted by these Directions.

A lot, or part of a lot, bounded by floors walls and ceilings need be delineated only.

Where one part of a lot is bounded by floors, walls and ceilings, and another part of the same lot is not, each part shall be separately described and dealt with as required by this Direction and Directions 24.18 to 24.25.

For the purposes of this Direction, a wall shall be a structure that is constructed from floor to ceiling ignoring any openings for doors and windows.

24.18 Boundaries of lots not bounded by walls, floors and ceilings:

Where a lot, or part of a lot, is not fully bounded by floors, walls and/or ceilings, the boundaries shall be defined either:

- ◆ by being fully dimensioned; and
 - with reference to structural elements accurately located on the plan; or
 - by connections to the outer boundaries of the base parcel;
- ◆ by reference to structural elements as permitted in specific cases in Directions 24.19 to 24.25.

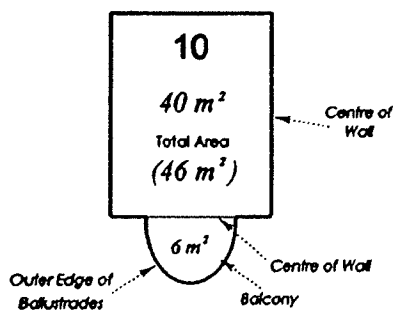

Note: Descriptions of the bounding features are for the purposes of this diagram only.

Figure 24.4: Illustrating a balcony

shown on the plan as a light line. Each part shall be dealt with as part lots, (See Directions 24.5 and 24.6), but it shall not be necessary to designate each part with the lot number and the descriptor "pt".

The corners of such lots or part lots must be readily discernible, and where not directly related to visible marks, immediately adjacent to such corners, shall be marked as required by the Surveyors Act 1977 and the Surveyors Regulation 1992.

Where a lot or part lot is defined under the provisions of this Direction, boundaries may be located in any position in relation to a wall, or may be remote from any wall.

Where part of a lot, fully bounded by floors, walls and ceilings, immediately adjoins another part of the same lot defined under this Direction, the division between the parts shall be the centre of the wall, and shall be

24.19 Balcony:

In the case of a balcony:

- ◆ the horizontal limits shall be defined by:
 - the outer edge of the balcony, or any projection of the balustrades, whichever is the greater;
 - Other boundaries shall be defined by walls, or as directed in Direction 24.18.
- ◆ The lower boundary shall be the centre of the floor of the balcony.
- ◆ The upper boundary shall be:
 - where the balcony is fully or partly covered by a ceiling, the centre of that ceiling, or the extension of that ceiling;
 - where the balcony is not covered by a ceiling, the horizontal extension of the upper boundaries of that part of the lot which it adjoins.
- ◆ the outer boundaries shall be the vertical planes through the outermost limits of the balcony to the intersections with its upper and lower boundaries.

See Figure .

24.20 Carport:

In the case of a carport:

- it shall be defined as directed in Directions 24.17 and 24.18; and
- the outer boundaries shall be the vertical planes through the outermost limits of a carport to the intersections with its upper and lower boundaries.

See Figure 24.5.

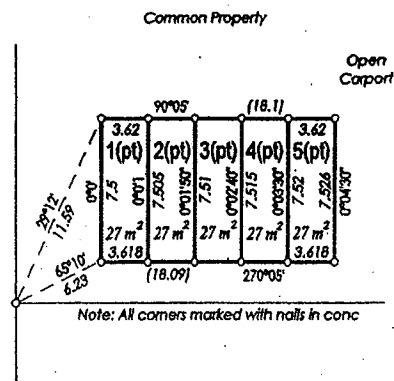

Note: All corners marked with nails in conc

Figure 24.5: Carport, roof only.

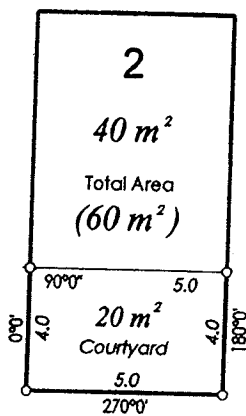

Courtyard is bounded by a low brick wall.

Figure 24.6: Illustrating a courtyard.

In the case of a carport:

- it shall be defined as directed in Directions 24.17 and 24.18; and
- the outer boundaries shall be the vertical planes through the outermost limits of a carport to the intersections with its upper and lower boundaries.

See Figure 24.5.

24.21 Courtyard:

In the case of a courtyard:

- ♦ it shall be defined as directed in Direction 24.18;
- ♦ A description of the defining feature shall be noted on the plan.
- ♦ the lower boundary of a courtyard shall be the centre of the floor;
- ♦ the upper boundary of a courtyard shall be the horizontal extension of the upper boundary of that part of the lot which it adjoins;
- ♦ the outer boundaries shall be the vertical planes through the outermost limits of a courtyard to the intersections with its upper and lower boundaries.

See Figure .

24.22 Garage:

In the case of a garage:

- ♦ it shall be defined as directed in Directions 24.17 and 24.18;
- ♦ the lower boundary shall be the centre of the floor;
- ♦ Where there is no ceiling to define the upper boundary of a garage:
 - Where there is an adjacent lot, defined under Direction 24.17 by floors, walls and ceilings, on the same level as a garage, the upper boundary of the garage shall be the horizontal extension of the upper boundary of that lot.
 - Where there is no adjacent lot, the upper boundary shall be defined on the plan by a vertical distance above the lower boundary. This vertical distance shall be no greater than five metres or the mean of the vertical distances between the upper and lower limits of lots within the building, whichever is the greater and shall be noted on the plan of the level containing the garage.

- ♦ the outer boundaries shall be the vertical planes through the outermost limits of a garage to the intersections with its upper and lower boundaries.

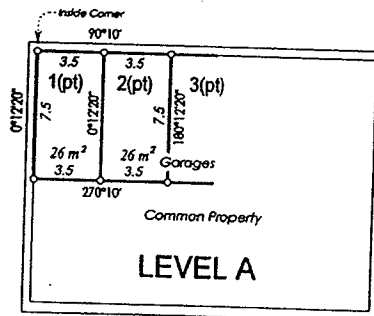

Note: Unless otherwise noted, all corners are ranset nails in concrete.

Note: Wall shown for illustrative purposes only. It is not required on an actual plan.

Figure 24.7: Illustrating a garage.

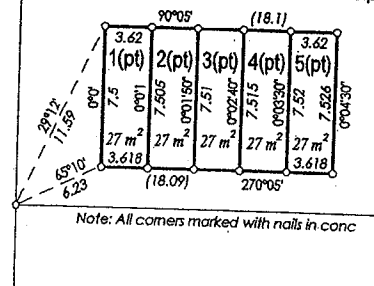

Note: All corners marked with nails in conc

Figure 24.5: Carport, roof only.

See Figure 24.7.

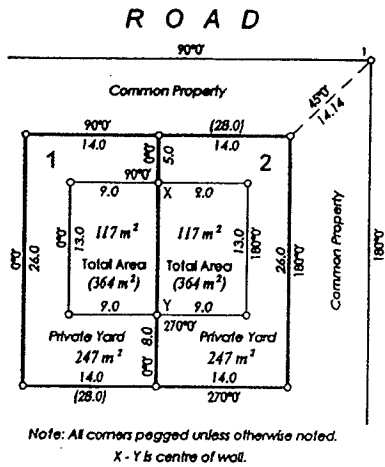

Figure 24.8: Private Yard within a larger Community Titles Scheme

it, and may not be restricted by any balconies or other parts of lots that may be on higher levels in other structures.

- ◆ Where a private yard adjoins a lot or part of a lot bounded by floors, walls and ceilings, the boundary between them is only for the purposes of a "part lot". (See Direction 24.18).

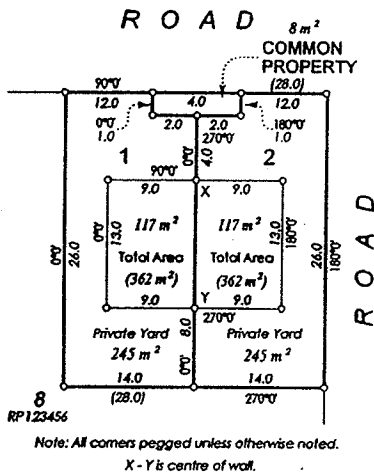

Figure 24.9: Private Yard taking up the whole of a Community Titles Scheme.

ceilings; and

- the boundaries of those parts of the lot that adjoin that part of the lot that is private yard are only shown as a boundary between parts of lots. (See Direction 24.17).

See Figure 24.8 and Figure 24.9.

24.24 Roofgarden:

In the case of a roofgarden:

- ◆ it shall be defined as directed in Direction 24.18;
- ◆ the lower boundary of a roofgarden shall be the centre of the floor;

24.23 Private Yard:

The following principles shall apply to private yards:

- ◆ Private Yards are unlimited in height and depth.
- ◆ Private Yards must be defined by being dimensioned on all boundaries, including those where they abut lots defined by floors, walls and ceilings, as required by Direction 24.17.
- ◆ Private Yards must be attached to a structure either directly; or indirectly by a courtyard.
- ◆ A private yard may not be attached to a lot or part of a lot that has another lot or part of another lot above it, and may not be restricted by any balconies or other parts of lots that may be on higher levels in other structures.

- ◆ Where a private yard fully surrounds the part of the lot within the structure:

- the boundary between the two is only shown as between part lots. (See Direction 24.18); and
- that part of the lot that is in a structure is not bounded by floors, walls and ceilings because it does not adjoin another lot or common property, and is therefore also unlimited in height and depth.

- ◆ If a private yard only partially surrounds the part of the lot within the structure:

- the boundaries of those parts of the lot within the structure that immediately adjoin other lots or common property are the floors, walls and

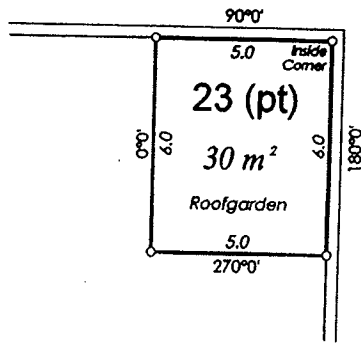

Note: Unless otherwise noted, all corners nails are in concrete.

Note: Wall shown for illustrative purposes only. It is not required on an actual plan.

Figure 24.10: Roofgarden.

See Figure 24.10.

24.25 Verandah:

In the case of a verandah:

- ◆ the horizontal limits of each verandah shall be defined by:
 - the outer edge of the verandah, or any projection of the balustrades;
 - Other boundaries shall be defined by walls, or as directed in Direction 24.18.
- ◆ The lower boundary shall be the centre of the floor of the verandah.
- ◆ The upper boundary shall be the centre of the ceiling of the verandah;
- ◆ the outer boundaries shall be the vertical planes through the outermost limits of the verandah to the intersections with its upper and lower boundaries.

See Figure 24.11.

24.26 Other Cases:

For all other cases, the general principles given in this Direction shall be applied.

24.27 Diagrams:

Where it is necessary to use diagrams to clearly illustrate detail, each shall be shown with the same orientation.

24.28 Easements:

Where an easement is shown as part of a building format plan, it shall be fully dimensioned and given an area. (See also Direction 21)

- ◆ where there is no ceiling to define the upper boundary of a roofgarden:
 - where there is an adjacent lot, defined under Direction 24.17 by floors, walls and ceilings, on the same level as a roofgarden, the upper boundary of the roofgarden shall be the horizontal extension of the upper boundary of that lot;
 - where there is no adjacent lot, the upper boundary shall be defined on the plan by a vertical distance above the lower boundary. This vertical distance shall be no greater than five metres or the mean of the vertical distances between the upper and lower limits of lots within the building, whichever is the greater and shall be noted on the plan of the level containing the roofgarden.
- ◆ the outer boundaries shall be the vertical planes through the outermost limits of a roofgarden to the intersections with its upper and lower boundaries.

1	2	3
152 m ²	152 m ²	144 m ²
Total Area (188 m ²)	Total Area (188 m ²)	Total Area (180 m ²)
36 m ² Verandah	36 m ² Verandah	36 m ² Verandah
Face	of	Balustrades

Note: "Face of Balustrades" is for the purposes of this diagram only.

Figure 24.11: Verandah.

Where an easement is required in common property and is wholly or partially contained within a structure, it must be surveyed as a volumetric easement in accordance with the provisions of Direction 25.6.

24.29 Encroachments:

Where any part of a building, including its footings, foundations or other projections proposed to be the subject of a Building Format plan, encroaches onto an adjoining lot or road, the requirements of this Direction shall be complied with.

Saving that:

- where the building is an existing building; or
- where it is not practical to do so;

it shall not be necessary to determine the extent of footings or foundations below the surface of the land.

24.29.1 Encroachment onto an adjoining lot or Unallocated State Land:

In the case of an encroachment onto an adjoining lot or Unallocated State Land, the acquisition of the necessary land, or, in the case of a lot, the registration of an easement, to cover the encroachment is required.

24.29.2 Encroachment onto road:

- ◆ Minor encroachments:

Subject to Local Government consent, the following shall be permitted:

- eaves, guttering, awnings and other such minor projections from the wall of the building on an existing building, or as required or permitted by the Local Government under the provisions of the Building Act 1975; and
- in the case of an existing building, up to half the width of the wall.

In each case, the Local Government shall consent, in Form 18, to the specific encroachments shown on the plan, and the consent shall be lodged with the plan.

This does not extend to include any part of a structure that forms, or is intended to form, any part of a lot, and that is on an existing building, or required or permitted by a Local Government under the provisions of the Building Act 1975.

- ◆ In all other cases of encroachments onto a road whether at, above or below ground level, one of the following is required:
 - permanent closure of the road and the issue of freehold title or term lease over the closed road in terms of the provisions of the Land Act 1994.
 - Temporary closure of the road and issue of a road licence over the closed road in terms of the provisions of the Land Act 1994.

(Early application should be made to the Minister where an encroachment onto a road is found.)

24.29.3 Maximum amount of encroachment:

Where the action taken to cover the encroachment is by other than by the acquisition of a freehold title, the amount of the encroachment of a building may not be such that the boundary of a Building Format lot would project beyond the boundaries of the base parcel. That is, the maximum amount of encroachment permitted is limited to half the width of the wall.

24.29.4 Where a Volumetric lot is created to cover an encroachment:

In the case of an existing building:

- ◆ which encroaches onto adjoining road or an adjoining lot; and
- ◆ for which a volumetric lot:
 - as the result of a road closure, has been the subject of a deed of grant from the State to the Registered Owners of the standard lot containing the building; or
 - in the case of an adjoining lot, has been transferred from the adjoining Registered Owners to the Registered Owners of the standard lot containing the building.
- ◆ and for which a Covenant to either the State or the Local Government as appropriate has been registered in terms of Section 97A of the Land Title Act to the effect that the volumetric lot will be held in the one ownership together with the standard lot on which the building encroaching is located;

the requirements of Direction 24.16 shall apply.

24.29.5 Provisions of the Land Act:

Attention is drawn to Chapter 3 Part 2 of the Land Act 1994 dealing with roads and Chapter 7 Part 2 dealing with Unlawful Occupation of Non-Freehold and Trust Land.

24.29.6 Certificate on Encroachment:

In addition to the Surveyors Certificate required by the provisions of the Surveyors Regulation, 1992, the surveyor shall place the following certificate on the reverse of the main plan:

I certify that:

***As far as it is practical to determine, no part of the building shown on this plan encroaches onto adjoining lots or road;**

***Part of the building shown on this plan encroaches onto adjoining * lots and road**

Licensed Surveyor/Director* Date

*** delete words not required.**

24.30 Plans of Amalgamation or Subdivision of lots:

Where a new plan deals with lots within a building format plan:

- The whole of the lots, and where a lot is in parts, all of the parts, being dealt with shall be shown on the plan as required by Direction 19, and delineated or dimensioned as required by Directions 24.17 and 24.18;

- Lot numbering is at the discretion of the surveyor, provided it follows the general numbering scheme adopted for the remainder of the development and is in accordance with Direction 23.3.

25. Volumetric Format Plans:

25.1 Subdivision:

A Volumetric Format plan may subdivide:

- a lot or lots and/or common property created on a Standard Format plan;
- a lot or lots and/or common property on a Building Format plan;
- a lot or lots and/or common property created on a Volumetric Format plan.

The whole of the base parcel being subdivided must be dealt with, and no undescribed balance or remainder shall be left. (See also Direction 19.14).

25.2 General:

25.2.1 Creation of Volumetric Parcels:

Volumetric Format plans deal with the creation of volumetric parcels by reference to levels related to a fixed datum as distinct from similar division by reference to floors, walls and ceilings as is the case with Building Format plans.

25.2.2 Bounded in all dimensions:

A volumetric parcel must be bounded in all dimensions. Creation of lots or leases with restrictions in either height or depth only shall not be permitted. However, easements with restrictions in either height or depth only will be accepted. See Directions 25.6 and 25.7.

Volumetric plans define parcels that:

- are fully enclosed by bounding surfaces, which may be other than vertical or horizontal.
- are above or below or partly above and partly below the surface of the ground.

25.2.3 Restricted or "In Strata" lots:

Existing lots that are currently described as "In Strata", and are only restricted in one direction, i.e. "to the depth of 10m" or "below 10m", are not volumetric. These lots may be referred to as "Restricted". When subdivided, they shall continue to be qualified by the term "Restricted". Any plan of survey dealing with existing "Restricted" lots shall be a Standard Format plan.

The use of terms that refer to "Strata" or "In Strata" shall not be used in any context in any document, including plans, other than as required by the Mixed Use Development Act;

25.2.4 Subdivision of a Standard Format lot:

Where a standard lot is subdivided by a plan which creates a volumetric lot or lots, the whole of that lot must be dealt with, and undescribed balances or remainders are not permitted. (See also Direction 19.14).

The remainder lot, which contains those parts of the original lot that remain after a volumetric lot has been excised, is considered to be a standard lot. This is the case although the footprint of the volumetric lot may coincide with the outer boundaries of the original lot. It shall not be qualified in any manner.

A note shall be placed on the face of the main plan stating that "Lot <lot number> is a Standard Format lot.

25.3 Lot Numbers:

Lot numbers on a Volumetric Format plan shall be numeric and numbered consecutively, omitting no numbers.

However, in the case of a staged development:

- provided that the numbering of lots in the completed development is consecutive, the numbering of lots on plans of stages in that development need not be consecutive; and
- in the case of a large lot that is proposed for future subdivision, it may be given a number that is higher than the total number of lots within the plan.

25.4 Part lots:

Part lots on a Volumetric Format plan are permitted and:

- may be used to illustrate the extent of a volumetric parcel;
- shall be used where a volumetric lot consists of several different levels each of differing horizontal dimensions and where each part shall comprise each of the different levels of the lot.

Parts of a lot, within a Volumetric Format plan only, shall be lettered sequentially commencing from A, i.e. Part A, Lot 12.

The provisions of this Direction may be used for leases and common property. In these cases, the word Lot shall be changed to lease or common property as appropriate.

In the case of easements, the same provisions may apply, with change in the descriptor from lot to easement. However, parts of easements must immediately adjoin one to the other.

25.5 Volumetric Parcels:

25.5.1 To be fully Defined:

Each volumetric parcel shall be fully defined by bounding surfaces, which may be other than vertical or horizontal.

25.5.2 "To the Depth" not acceptable:

It is unacceptable to specify "above or below a depth from the surface" for new boundaries since this is subject to change and not capable of mathematical definition. It is acceptable to show a reference to the natural ground surface or to a structural feature from new boundaries, provided the information is incidental only and all bounding surfaces are defined as directed herein.

25.5.3 Area of footprint:

Each volumetric parcel shall be given an area which is the area of the footprint. In the case of multiple parts of a parcel, a footprint shall be shown for each part and each shall be given a separate area.

25.5.4 Volume:

Each volumetric parcel shall be given a volume in cubic metres.

- For volumes less than 100,000 cubic metres, the volume shall be shown to the nearest cubic metre with any fractions of a cubic metre discarded.
- For volumes 100,000 cubic metres and above, the volume shall be shown in exponential notation with the mantissa taken to 5 significant figures. For example 1.3215×10^6 .

Where a parcel is in parts, each part shall be given a volume, and the total volume shall be noted within the largest part or, if insufficient space, may be noted on the face of the plan.

Saving that showing the volume for a volumetric easement is optional.

25.6 Volumetric Easements:

Volumetric easements shall be dealt with as for other volumetric parcels, other than as permitted in Directions 21 and 25.5.4.

25.7 Volumetric Leases:

Where a lease is to be restricted vertically, it shall be restricted in both height and depth and defined as a volumetric lease in accordance with the general requirements of this Direction.

A lease that is "within a building" is not normally to be considered a volumetric lease unless there is an unusual restriction in height contained in the covenants. In this case, the requirements noted in this Direction shall apply.

25.7.1 Leases on a Survey Plan:

A lease being defined on a survey plan shall follow the normal requirements for other volumetric parcels and shall be defined on a volumetric format plan.

25.7.2 Leases on a Sketch Plan:

A lease being defined on a sketch plan shall be dealt with as required in Direction 20, and shall follow the normal requirements for other volumetric parcels.

25.8 Description of Volumetric parcels:

As the format of the plan, volumetric, is indicative of the type of parcel created, it is unnecessary to qualify parcels with the term "volumetric".

25.9 Marking of Volumetric parcels:

Marking of volumetric lots shall comply with the normal provisions of survey marking where this is possible. However, in most cases, it will not be practical to mark volumetric parcels, and every opportunity should be taken to reference corners to existing structures, or to marks inserted therein.

25.10 Definition of Volumetric parcels:

25.10.1 Intersections and vertices to be defined:

All intersections of the bounding surfaces of a parcel, and the vertices thereof, shall be defined by either:

- polar; or
- if necessary in the interests of clarity, polar dimensions and rectangular co-ordinates; and
- levels on the Australian Height Datum,

unless the provisions of Direction 25.10.5 in the case of horizontal definition or Direction 25.10.6 in the case of vertical definition are adopted.

25.10.2 Permanent Marks to be noted:

The Permanent Marks used for the datum shall be shown on the plan together with their levels.

25.10.3 Polar Dimensions:

Where polar dimensions are shown, the bearing shall be the bearing of a vertical plane that contains the bounding edge, and the distance shall be the true slope distance along the bounding edge.

25.10.4 Rectangular Co-ordinates:

Where the definition of a parcel includes rectangular co-ordinates:

- The origin of, and the co-ordinate system used, shall be clearly shown on the face of the main plan;
- The co-ordinates of each corner of the parcel shall be shown either on the face of the plan or in a tabulation;
- Where the co-ordinate system is the Australian Map Grid, the co-ordinates of at least one Permanent Mark adjacent to the survey, and the co-ordinates of the Permanent Mark used for the datum of the Australian Map Grid Co-ordinates, shall be shown on the main plan.
- Co-ordinates on the Australian Map Grid may be truncated by subtracting from every northing value on the plan a fixed even offset, and from every easting value on the plan a fixed even offset. The adopted offsets shall be prominently noted on the main plan.
- Where the co-ordinate system is other than the Australian Map Grid, the co-ordinates of at least two Permanent Marks outside the confines of the survey shall be shown on the plan together with at least one additional Permanent Mark within the confines of the plan which should, where possible, be affixed to a permanent structure.
- The Permanent Marks adjacent to the survey noted in this Direction shall, in addition, be given levels on the datum used in the survey.

25.10.5 Parcel bounded by vertical planes:

Where the bounding surfaces defining the horizontal limits of the parcel are vertical planes, it shall be sufficient to define the horizontal dimensions of the lot by dimensions shown on the footprint provided that, by doing so, no ambiguity is introduced into the definition of the parcel.

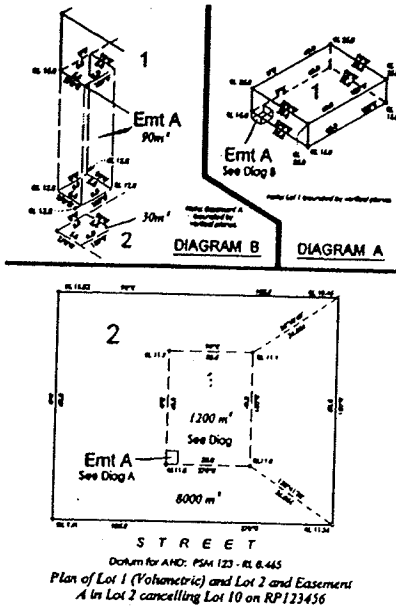

Figure 25.12: Plan showing an easement.

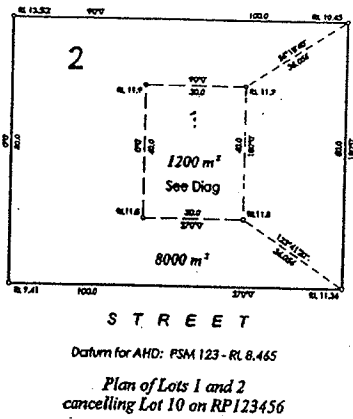
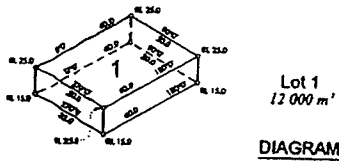

Figure 25.1: Plan showing a volumetric parcel by dimensions.

of the plan which should, where possible, be affixed to a permanent structure.

These dimensions shall include:

- dimensions for the projections of the bounding edges onto the footprint; and
- dimensions to locate the projection of any vertices onto the footprint.

To avoid ambiguity in this Direction, a change of grade in a bounding surface is considered to be a bounding edge and must be fully dimensioned.

Rectangular co-ordinates may also be included, if such would add to the clarity of the definition of the parcel.

Where the provisions of this Direction are used, a note shall be made on each sheet of the plan on which it is used stating "Lot <lot number> bounded by vertical planes".

In the case of easements and leases, the wording should be changed as appropriate.

25.10.6 Australia Height Datum unavailable:

Where Australian Height Datum is not available in the immediate area of the survey, and it would not be economically practical to transfer Australian Height Datum, another datum in general use in the area may be used provided that:

- prior approval of the examining authority for surveys in the area of the survey has been obtained;
- full details of the datum adopted are noted on the main plan; and

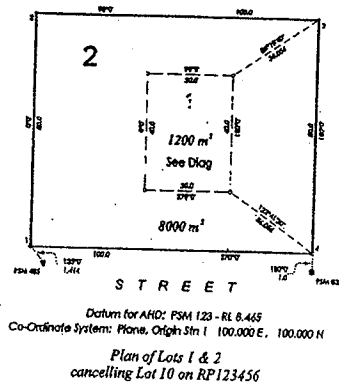
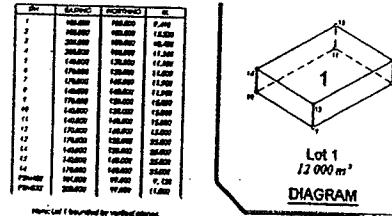

Figure 25.2: Plan showing a volumetric parcel by co-ordinates

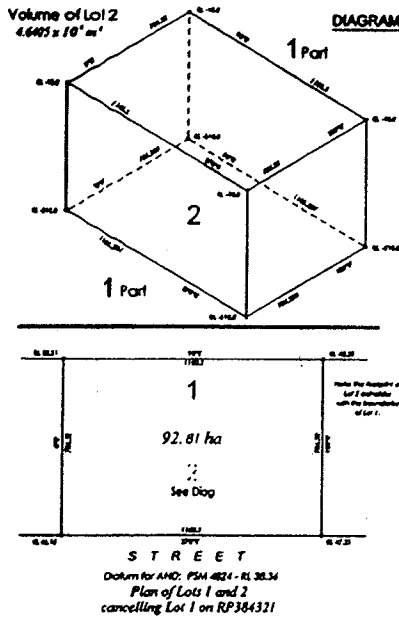

Figure 25.3: Plan of a volumetric lot with the same outer dimensions as the base parcel.

25.11 References to walls and floors:

When reference is being made to walls and floors on a plan, care should be taken with the wording of any notation so that it cannot be inferred that the feature is intended to define the bounding surface. A bounding surface must be defined by measurements shown on the plan. Any references to structural elements of a building should be incidental only.

No objection will be taken to:

- a statement to the effect that a bounding surface “generally follows” or is “generally limited by”; and/or
- references from vertices to structural elements, ie, floors, corners of walls etc.

25.12 Plans of Volumetric parcels:

See Figure 25.1 to Figure 25.3.

25.12.1 Isometric Diagram:

A plan shall show a three dimensional isometric representation of the parcel or parcels which are the subject of the plan, drawn to scale and in such a manner which will allow all details and notations to be clearly and unambiguously shown.

If the scale of the plan is too small to allow all information to be clearly shown, diagrams may be used. See Direction 25.12.6.

In the case of easements, the bounding edges in the isometric diagram may be constructed in full lines instead of broken lines, if this would make the diagram clearer. Note that the lines bounding the footprint of the easement must be shown in broken lines regardless of the line style adopted in the isometric diagram.

25.12.2 Dimensions to be shown:

In the case of a plan of a volumetric parcel which includes co-ordinates, the dimensions of the base lot shall be shown both in polar dimensions and co-ordinates.

25.12.3 Footprint of lot above or below the surface:

Where a parcel created on a volumetric plan is located above or below the ground surface of another lot:

- the footprint shall be shown on the plan in broken lines and fully dimensioned;
- In the case of a volumetric parcel defined by polar dimensions only, at least two corners of the footprint shall each be independently connected to at least one corner of the base lot by direct connection;
- In the case of a plan of a volumetric parcel which includes co-ordinates, the footprint shall, in addition, be defined by co-ordinates;

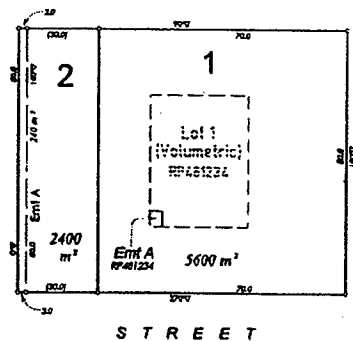

Figure 25.4: Subdivision of a "remainder" lot.

- Where a parcel created on a volumetric plan consists of several parts on different levels with different horizontal dimensions, the provisions of this Direction shall apply to each part;
- Where the outer boundaries of a footprint coincide with the outer boundaries of the base parcel, an appropriate note shall be made on the face of the plan

25.12.4 Footprint of lot intersecting the surface:

Where a volumetric lot intersects the ground surface of another lot:

- the boundaries on the surface so intersected shall be shown on the plan in broken lines, marked as required by the Surveyors Act 1977 and the Surveyors Regulation 1992 and fully dimensioned;
- In the case of a volumetric lot defined by polar dimensions only, at least two corners of the intersecting figure shall each be independently connected to at least one corner of the base lot by direct connection.
- In the case of a plan of a volumetric lot which includes co-ordinates, the corners of the intersecting figure shall, in addition, be defined by co-ordinates.

25.12.5 Ground levels on footprint:

In addition to the requirements of Directions 0 and 25.12.4, levels of the existing ground surface at the corners of the footprint on the surface shall be shown on the face of the plan or in a tabulation. Where the original ground level has been lost, an estimation of the original ground level shall be sufficient.

As these levels are required only to illustrate the location of the parcel relative to ground level, approximate values only are required.

25.12.6 Diagrams:

Generally, the orientation of any diagram shall be the same as the main plan. However, if it is necessary to show a diagram with a different orientation, the diagram shall be clearly noted to that effect. If it is necessary to overcome ambiguity, a volumetric lot, or a part thereof, may be shown in several diagrams with different viewpoints.

Diagrams may be drawn "not to scale", but, where-ever possible, relativity in scale and bearing should be maintained.

(Intentionally Blank)

26. Common Property:

26.1 Community Management Statement required:

Common Property may not be created on a plan unless:

- in the case of the first plan in a scheme, a First Community Management Statement is lodged to accompany the plan;
- in the case of subsequent plans, a New Community Management Statement is lodged to accompany the plan unless the plan is consistent with the existing Community Management Statement.

26.2 Defined as directed for format:

Common property shall be dimensioned or delineated as directed for the format of plan being prepared.

26.3 Area:

An area for common property shall be noted on each standard format plan that creates common property.

26.4 Footprint in a Volumetric Format plan:

In the case of a volumetric format plan:

- the area of the footprint of the projection of the outermost limits of common property shall be taken as the area of the common property and shall be noted on the face of the plan. In a staged Community Titles Scheme, the total area, or remaining area in the case of an excision from common property, of common property created within the Scheme shall be noted on any plan that amends common property.
- a volume for common property shall be noted on each volumetric format plan that creates common property. In a staged Community Titles Scheme, the total volume, or remaining volume in the case of an excision from common property, of common property created within the Scheme shall be noted on any plan that amends common property.

26.5 Re-dimension not required:

Where additional common property is created (for example, as in a staged Community Titles Scheme), or common property is excised, it is not necessary to re-dimension or re-delineate the full extent of common property.

26.6 Subdivision:

Where common property on a plan is subdivided into lots and/or common property by the registration of another plan, the lots or common property so created shall be dimensioned to the same standard as required for the format of the plan that is subdividing the common property.

26.6.1 Common Property subdivided into lots:

Where part of Common Property is subdivided and included in a lot or lots within a Community Titles Scheme:

- a plan shall be prepared showing the division of common property into lots. It is not necessary to redimension or re-delineate that part of common property remaining.
- the description shall refer to the new lot or lots cancelling common property or part of common property on the plan or plans on which it was created;

26.6.2 Lots converted to Common Property:

Where part of a lot within a Community Titles Scheme is to be converted to Common Property:

- a plan shall be prepared showing the division of the lot into a new lot or lots and common property;
- the description shall refer to the new lot or lots (which are the balance of the original lot) and common property. The cancelling clause shall refer to the lot being subdivided.

Where the whole of a lot within a Community Titles Scheme is to be converted to common property:

- a plan shall be prepared showing the conversion of the lot into common property;
- the description shall refer to common property cancelling the lot on plan being subdivided.

26.7 Easements in Common Property:

A plan shall be prepared showing the easement. Where the new easement covers part of several parts of common property, it shall not be necessary to create separate areas for those parts of the easement that are in each separate part of common property;

The description on the plan shall be "Easement <alpha> in Common Property on the plan or plans that created the common property". Where necessary, "Proposed" shall be used.

26.8 Exclusive Use Areas:

Where a plan of an Exclusive Use Area is required within a Community Titles Scheme, it shall be prepared in accordance with the provisions of Direction 20.

27. Transferring lots into or out of a Community Titles Scheme:

27.1 Lot to be added to Common Property:

Where all or part of a lot outside a Community Titles Scheme is to be added to Common Property:

- ◆ The lot must immediately adjoin the Scheme;
- ◆ Where part of a lot only is to be dealt with, that lot shall be subdivided on a standard or volumetric format plan as appropriate;
- ◆ A transfer, over the lot to be transferred, in favour of the body corporate shall be lodged, together with:
 - a New Community Management Statement; and
 - a plan converting the lot to be transferred to common property. The description of this plan shall be "common property cancelling the lot on plan description".

The plan, transfer and New Community Management Statement shall be lodged and registered simultaneously.

It is not necessary for the new common property to be amalgamated by a plan of amalgamation with existing common property.

27.2 Lot to be added to a Community Title Lot:

Where all or part of a lot outside a Community Titles Scheme is to be added to an adjoining lot within a Community Titles Scheme:

- ◆ The lot must immediately adjoin the Scheme;
- ◆ Where part of a lot only is to be dealt with, that lot shall be subdivided on a standard or volumetric format plan as appropriate;
- ◆ A transfer, over the lot to be transferred, in favour of the registered owner of the Community Titles lot shall be lodged, together with:
 - a New Community Management Statement; and
 - a plan showing the amalgamation the Community Titles Lot and the adjoining lot.

The plan, transfer and New Community Management Statement shall be lodged and registered simultaneously.

The provisions of this Direction may not be used where the Community Titles Scheme was created over a building format plan.

27.3 Part of Common Property to be excised:

Where part of common property is to be excised from a Community Titles Scheme:

27.3.1 In the case of a Community Titles Scheme over a standard or volumetric format lot:

- a plan in either standard or volumetric format as appropriate shall be prepared showing a lot over the part to be excised.
- This plan shall be lodged together with a transfer from the body corporate and a New Community Management Statement.

The plan, transfer and New Community Management Statement shall be lodged and registered simultaneously.

27.3.2 In the case of a Community Titles Scheme over a building format plan:

- ◆ where the common property is outside a building or structure:
 - a plan in either standard or volumetric format as appropriate shall be prepared showing a lot over the part to be excised;
 - the balance of the base parcel shall be fully dimensioned, together with an area which will be the total ground area within the outer boundaries of the remaining base parcel;
 - the outline of the building shall be plotted in the correct relationship to the outer boundaries of the remaining base parcel. Where the original connections to the building or buildings would no longer be correct by reason of relocation of the corners of the base parcel to which they were connected, new connections shall be made to the new corners;
 - The description shall be lot and common property cancelling common property.
 - This plan shall be lodged together with a transfer from the body corporate and a New Community Management Statement.

The plan, transfer and New Community Management Statement shall be lodged and registered simultaneously.

- ◆ where the common property is inside a building or structure:
 - a plan in volumetric format shall be prepared showing a lot over the part to be excised;
 - The description shall be lot cancelling part of common property.
 - The lot so created shall be amalgamated with an adjoining lot by a plan of amalgamation in the appropriate format.
 - This plan shall be lodged together with a transfer from the body corporate and a New Community Management Statement.

The plan, transfer and New Community Management Statement shall be lodged and registered simultaneously.

27.4 Part of a lot to be excised:

Where all or part of a lot is to be excised from a Community Titles Scheme:

- ◆ In the case of Standard and Volumetric format lots:
 - Where part of a lot only is to be dealt with, a plan in either standard or volumetric format as appropriate shall be prepared subdividing the lot affected.

- The transfer of the lot from the Body Corporate and a New Community Management Statement shall be lodged.

The plan, transfer and New Community Management Statement shall be lodged and registered simultaneously.

◆ In the case of Building Format lots:

- a plan in volumetric format shall be prepared showing a lot over the part to be excised and the remainder;
- The description shall be lots cancelling a lot.
- The lot so created shall be amalgamated with an adjoining lot, by a plan of amalgamation in the appropriate format.
- This plan shall be lodged together with a transfer from the body corporate and a New Community Management Statement.

The plans, transfer and New Community Management Statement shall be lodged and registered simultaneously.

27.5 Areas of common property:

Where common property is created or excised as directed in these Directions, areas shall be provided as directed in Direction 26.

(Intentionally Blank)

28. Staged Subdivisions:

Where it is desired to carry out a staged subdivision over land that will ultimately be a Community Titles Scheme, one of four methods may be utilised:

28.1 Method 1:

- Where the base parcel does not already consist of several parcels, it may be subdivided into standard or volumetric format lots as appropriate. These are referred to in this Direction as the original lots;
- One of these lots may then be subdivided into scheme lots and common property;
- In the Community Management Statement, which shall be lodged to accompany the plan creating common property, the other original lots shall be noted as being part of the Community Titles Scheme, together with the proposed staged development of those lots; and
- Development may proceed on the other original lots as required and in accordance with the Community Management Statement.

28.2 Method 2:

- The base parcel may be subdivided into standard or volumetric format lots as appropriate together with at least part of the proposed common property;
- In the Community Management Statement, which shall be lodged to accompany the plan, the proposed staged development of the lots shall be noted; and
- Development may proceed as required and in accordance with the Community Management Statement.

28.3 Method 3:

- The base parcel may be subdivided into scheme lots and common property by a standard or volumetric format plan as appropriate, with at least one lot being noted in the Community Management Statement as being intended for future subdivision.
- Development may proceed as required and in accordance with the Community Management Statement on the lot noted as being for future subdivision.

28.4 Method 4:

- The base parcel may be subdivided into scheme lots and common property, covered by a Community Management Statement.
- A lot may be subdivided out of the common property, transferred to a third party for development, but being noted in a New Community Management Statement as remaining part of the original scheme.
- On subdivision of this lot, the new lots become scheme lots.

28.5 Method 5:

- Where part of a base parcel consisting of Standard Format lots only is subdivided by a Building Format plan, leaving a remainder parcel that is not common property of that

Building Format plan, the remainder parcel remains a Standard Format lot. (See Direction 24.3.2)

- In the Community Management Statement, which shall be lodged to accompany the Building Format plan, the proposed staged development of the remainder Standard Format lot shall be noted; and
- Development may proceed as required and in accordance with the Community Management Statement.

29. Reservation of a Name for a Community Titles Scheme:

A name for a Community Titles Scheme shall be shown in the appropriate location on the reverse of the main plan prior to lodgement.

The name to be used on the plan may be reserved in the land registry prior to the lodgement of a plan.

To reserve a name, a person shall make a request to the Registrar in a General Request Form, Form 14, clearly specifying the name requested to be reserved and clearly identifying the land that is proposed for the Scheme.

30. Termination:

Where a Community Titles Scheme is to be terminated:

- ◆ Where the base parcel consists only of standard or volumetric lots:
 - all lots and common property subject to the Community Management Statement creating that Scheme shall be amalgamated into one lot by a plan of amalgamation in standard or volumetric format as appropriate;
 - all easements that are in lots or common property that are defined within a structure must be surrendered to precede the lodgement of this plan;
 - the plan shall be signed by the Body Corporate on behalf of all the proprietors.
- ◆ Where the base parcel consists of both standard and volumetric lots as permitted in Direction 24.29.4 all lots and common property subject to the Community Management Statement creating that Scheme shall be amalgamated:
 - in a standard format plan to show as one lot that part of the Scheme that consists of land that is unrestricted in height and depth;
 - in a volumetric format plan to show that part of the Scheme that is volumetric. Where there were more than one original volumetric lot in the base parcel, this plan may show separate lots.
 - all easements that are in lots or common property that are defined within a structure must be surrendered to precede the lodgement of this plan;
 - the plans shall be signed by the Body Corporate on behalf of all the proprietors.

These plans shall be lodged together with a covenant binding the volumetric lot or lots to the standard parcel.

(Intentionally Blank)

31. Mixed Use Development Act:

Where an application under the Mixed Use Development Act (MUD Act) has been submitted to the Local Government prior to the commencement of the Body Corporate and Community Management Act, the provisions of that Act may be used. Where such an application has not been made at the date of commencement, any development must take place under the provisions of the Land Title Act as amended, and if applicable, the Body Corporate and Community Management Act.

Where development is to proceed under the provisions of the Mixed Use Act, the following Directions shall apply.

31.1 Definitions for MUD Act Plans:

For this section, the following definitions shall apply:

Balance: The word "Balance" is used in the context of a lot that is intended for future subdivision, and as defined in the Act. It may not be a Balance lot as is current Land Title Act practice.

Community Development Lot: A lot on a community plan that is not a community property lot.

Community Plan: A Community Plan divides the site into Community Property Lots and Community Development Lots and is the first plan required. It can also leave a "balance" Community Development Lot that can be later subdivided. Lots created on a Community Plan may be amalgamated or subdivided into further Community Title or Community Property lots by Community Plans of Amalgamation and Subdivision.

Community Property Lot: A Community Property Lot is in effect "common property" on a MUD Act Community Plan.

Precinct Development Lot: A lot on a Precinct Plan that is not a precinct property lot.

Precinct Plan: A Precinct Plan subdivides a Community Development Lot into Precinct development Lots and Precinct Property Lots. It can also leave a "balance" Precinct Development Lot that may be later subdivided. Lots created on a Precinct Plan may be amalgamated or subdivided into further Precinct Community Lots or Precinct Property lots by Precinct Plans of Amalgamation and Subdivision.

Precinct Property Lot: A Precinct Property Lot is in effect "common property" on a MUD Act Precinct Plan.

Stratum Lot: A lot on a stratum plan that is limited wholly or partly in height or depth or both.

Stratum Plan: A Stratum Plan subdivides Community Development Lots, Precinct Development Lots, or balance Precinct Development Lots into Community or Precinct Stratum lots.

31.2 Introduction

Approvals given under the provisions of the Mixed Use Development Act may cover several different areas:

- The Site of a mixed use scheme consists of land within the boundaries of the area that has been fully approved for development. It is only within a Site that surveys under the Act may

proceed. The site must generally be in one parcel, but a site may enclose two or more parcels where these are separated by road, railway, tramway, or boundary watercourse. (See Section 60(4) of the Mixed Use Development Act).

- To allow for future development, an area may be identified as a Future Development Area. These are noted on an overall master plan as such, but have not been approved in the detail necessary for any development to proceed. Future Development Areas may not be subdivided under the Act and cannot be described as such in a Community Plan of Subdivision.

Because of these requirements, and before a development containing a Site and a Future Development Area can proceed, a standard format plan must be prepared for the two different areas, with titles being created under the Land Title Act.

31.3 Plan Forms to be used with the MUD Act:

Form 21 Version 2, Survey Plan, approved for use under the Land Title Act, shall be used for the purpose of preparing plans under the Mixed Use Development Act. If additional sheets are necessary, Form 21A Version 1, approved for use under the Land Title Act, shall be used.

The general requirements of Direction 19 shall apply to forms used, with modifications as noted in the following Directions.

31.3.1 Modifications of form 21:

Form 21 shall be modified in accordance with the following:

◆ On the Face:

- Immediately underneath the heading "Survey Plan", note "Community Plan", "Precinct Plan" or "Stratum Plan" as appropriate.
- In the top left hand corner underneath "Form 21 Version 2", insert "NAME OF DEVELOPMENT:".
- The Format of a plan shall be "Volumetric" for Stratum Plans, and "Standard" for all others.

◆ On the Reverse:

• In item 1:

⇒ Delete "or Lessees" from the heading, so that it now reads "Certificate of Registered Owners:"

⇒ delete the wording of both Registered Owners and Lessees certificates and insert "As Registered Owners of this land, agree to this plan and agree to the voting entitlements shown hereon".

- In Item 2, delete the wording of the Local Government certificate and insert "certifies that the requirements of the Mixed Use Development Act 1993 have been complied with and that this plan has been approved".
- In Item 3, delete "Plans with Community" from the heading so that it now reads "Management Statement".

Delete "CMS No." And insert "Dealing Number of Management Statement:".

- In available space on the right hand side, add an additional item headed "Name and address of Body Corporate."
- In available space on the right hand side, add a schedule entitled "Voting Entitlements". This schedule shall be in the format:

VOTING ENTITLEMENTS

Lot	Entitlement	Lot	Entitlement	Lot	Entitlement
Total this Schedule					
Additional Schedule (Sheets)					
TOTAL ALL ENTITLEMENTS					

The schedule may be made as large as necessary as will fit in the available space. If space is insufficient, an additional schedule may be placed on an additional sheet. However, the main schedule, together with the total of all entitlements must appear on the reverse of the Form 21.

31.3.2 Modification of form 21A:

- Immediately underneath the heading "Additional Sheet", note "Community Plan", "Precinct Plan" or "Stratum Plan" as appropriate.
- In the top left hand corner underneath "Form 21A Version 1", insert "NAME OF DEVELOPMENT."

31.4 Plan Types:

Three main types of plans are referred to in the Act:

- Community Plan;
- Precinct Plan; and
- Stratum Plan.

By Section 63, all land within the "site" must be dealt with by a Community Plan, and by Section 86, all land within a Community Development Lot must be dealt with by a Precinct Plan. The Act is not so clear with regard to Stratum Plans, but there is no doubt, taking several sections into account, that a Stratum Plan must deal with the whole of a lot of whichever type that it subdivides.

The word "Balance" as used in the following Directions, is used in the context of a lot that is intended for future subdivision, and as defined in the Act. It may not be a Balance lot as was Land Title Act practice.

On all plans, the name of the development shall be shown on the front of the plan, and in Item 3 on the reverse. Where the plan is other than the initial Community Development plan, it shall also show in Item 3 the dealing number of the initial Management Statement.

31.4.1 Community Plan:

A Community Plan divides the site into Community Property Lots and Community Development Lots and is the first plan required. It may also leave a balance Community Development Lot that can be later subdivided. Lots created on a Community Plan may be amalgamated or subdivided into further Community Title or Community Property lots by Community Plans of Amalgamation and Subdivision.

A community plan must deal with the whole of the lot it is cancelling. Where a balance lot as defined in the Act is required, it must be fully described, given a standard lot number of the correct type, and qualified on the face of the plan with a note "Community Development Lot <number> is a Balance Community Development Lot". The provisions of Direction 19.14 may be used.

A Community Plan is prepared as a Standard Format plan.

31.4.2 Precinct Plan:

A Precinct Plan subdivides a Community Development Lot into Precinct development Lots and Precinct Property Lots. It may also leave a balance Precinct Development Lot that may be later subdivided. Lots created on a Precinct Plan may be amalgamated or subdivided into further Precinct Community Lots or Precinct Property lots by Precinct Plans of Amalgamation and Subdivision.

A precinct plan must deal with the whole of the lot it is cancelling. Where a balance lot as defined in the Act is required, it must be fully described, given a standard lot number of the correct type, and qualified on the face of the plan with a note "Precinct Development Lot <number> is a Balance Precinct Development Lot". The provisions of Direction 19.14 may be used.

A Precinct Plan is prepared as a Standard Format plan.

31.4.3 Stratum Plan:

A Stratum Plan subdivides Community Development Lots, Precinct Development Lots, or balance Precinct Development Lots into Community or Precinct Stratum lots. There appears to be no provision to subdivide a balance Community Development Lot into Community Stratum Lots, nor is there any provision to create Stratum Property Lots. Lots created on a Stratum Plan may be amalgamated or subdivided into further Stratum Lots of the same type by Stratum Plans of Amalgamation and Subdivision.

A stratum plan must deal with the whole of the lot it is cancelling. Balance lots are not permitted. Notwithstanding the provisions of Direction 25, the air space above, unlimited by height, and the ground space below, unlimited by depth (or to the limit in the original Land Title Act allotment), must be included in a lot or lots, unless an existing Stratum Lot is being dealt with. The provisions of Direction 19.14 may be used.

Stratum lots shall be defined on a volumetric format plan, and follow the requirements of Direction 25, other than:

- as permitted for lots unlimited in height or depth as noted in the preceding paragraph;
- the term "Stratum" shall be used instead of "volumetric", other than in the definition of the format of the plan;
- where a stratum lot is unlimited in either height or depth, this shall be indicated on the plan by arrows at the corners of the vertices on the lot pointing upwards or downwards as appropriate.

Stratum Lot names are derived from the lot type they are subdividing. If a Community Development Lot is being subdivided by a Stratum Plan, it creates "Community Stratum Lots". If a Precinct Development Lot is being subdivided, it creates "Precinct Stratum Lots".

31.4.4 Boundary Adjustment Plan:

Another plan type is a Boundary Adjustment Plan. They only apply to "minor amendments" that are "necessary to resolve a problem in relation to the management, development or subdivision of the site...". The definition of "minor" is the responsibility of the Local Government concerned.

31.4.5 Amendment Plans:

For the purposes of this document, an Amendment Plan includes Plans of Amalgamation, Boundary Adjustment Plans and Plans of Subdivision where the plan is creating lots of the same type. Plans of amendment create lots of the same type as the parent lot.

The description of an amendment plan shall be "<Type> Plan of Boundary Adjustment of", "<Type> Plan of Amalgamation of" or "<Type> Plan of Subdivision of" as the case may be.

Lots on an amendment plan must be numbered consecutively from the highest number in the development, other than a lot intended for further subdivision. Note that <Type> Property Lots must be numbered under the MUD Act, but there is no requirement that they be numbered in any particular order.

31.5 Subdivision into Building Units and Group Titles Lots:

Other than in the case of community and precinct property lots, all lots created under the above plans may be further subdivided by plans under the Building Units and Group Titles Act 1980, with the exception that stratum lots may only be subdivided by a Building Units plan.

A Group Title lot created under the provisions of the MUD Act may be further subdivided by a Building Units plan, notwithstanding any other provision of the Building Units and Group Titles Act 1980.

These subdivisions follow the normal provisions laid out in the Building Units and Group Titles Act 1980 and the Regulations thereunder. (This Act remains in force for developments under the Mixed Use Development Act).

31.6 Lots:

31.6.1 Lot Numbering:

Development Lots and Property Lots in a Plan must be numbered consecutively. If the plan contains a lot or lots that are intended for future subdivision, these must be given a higher number than there are lots in a plan. Surveyors should consider any possible redesign of later stages of the project when selecting this number. The number used must not be repeated in later amendment plans.

Lot numbers within the completed development must be continuous, commencing from 1 with no gaps.

31.6.2 Part Lots:

Part lots shall be dealt with as directed in Directions 23 and 25, save that a Stratum lot may be in several parts, not necessarily immediately adjacent to each other. However, in this latter case,

the provisions of Direction 25.4, other than that part referring to the requirement that all parts shall immediately adjoin each other shall apply to each part.

31.6.3 Lot Descriptions:

Each lot must bear a description of its type, i.e. Community Development Lot, Precinct Property Lot etc.

Where space is insufficient, lot descriptors may be abbreviated to their capital initials. For example, CDL, CPL, CSL, PDL, PPL, PSL.

31.7 Descriptions:

Descriptions for plans under the MUD Act are, of necessity, somewhat different to those under the Land Title Act and the BUGT Act.

The Description of the plan must be "<Type> Plan of", where the <Type> is replaced by the type of plan, i.e. Community, Precinct or Stratum.

◆ Examples

- An initial Community Plan:

Community Plan of Community Development Lots 1 to 10 and 100 and Community Property Lots 11 to 13 cancelling Lot 1 on RP123456.

Note: Lot 100 is intended for further subdivision.

- Plan of amendment:

Community Plan of Subdivision of Community Development Lots 11, 12 and 101 Cancelling Community Development Lot 100 on SP89124.

- Precinct Plan subdividing a Community Development Lot:

Precinct Plan of Precinct Development Lots 1 to 5 and Precinct Property Lots 6 and 7 Cancelling Community Development Lot 2 on SP89124.

- A Precinct Stratum plan subdividing a Precinct Development lot into Precinct Stratum Lots:

Precinct Stratum Plan of Precinct Stratum Lots 1, 2 and 3 Cancelling Precinct Development Lot 4 on SP89125.

- Stratum Boundary Adjustment Plan:

Stratum Boundary Adjustment Plan of <Type> Stratum Lots 22 and 23 Cancelling <Type> Stratum Lots 4 and 5 SP89256.

31.8 Restricted Lots:

Where a Community or Precinct Plan is subdividing a Land Title Act allotment, which is itself restricted, the provisions of Direction 23.5 shall apply.

31.9 Extinguishment

Under the current Act, extinguishment of MUD plans will be very difficult, if not impossible. If extinguished, the comatose title will be reactivated, and becomes the title for the land.

If the dimensions on the plan defining the lot contained in the comatose title differ from the dimensions on the extinguished plan, a plan of resurvey is required to immediately follow the extinguishment. A new indefeasible title will be created off that plan. This plan may be compiled from the extinguished plan, subject to the normal requirements for compiled plans.

31.10 Miscellaneous

All plans are subject to consent by various government agencies if in a controlled zone. e.g. Coastal Management Control District, Channel Area, Drainage Area etc.

(Intentionally Blank)

32. Diagrams:

The diagrams in these Directions are illustrations of basic principles only, and do not necessarily contain all the information that may be required in actual practice. Reference should be made to these Directions for the full requirements of the Registrar.

33. Specimen Plans:

The attached specimen plans have been prepared to illustrate some of the major actions that may be required under these Directions. Obviously, it is not possible to illustrate every possible action. Where doubt exists as to the appropriate method to prepare a plan for a particular action, contact should be made with Departmental officers.

It should be noted that:

- these plans may not be correct in every respect, and may not show all information that is required for lodgement of a plan under the Land Title Act; and
- to save space, several additional sheets have been printed back to back, contrary to the requirements of Direction 0. This should not be taken as a precedent for preparing plans contrary to the requirements of this Direction.

The surveyors names used in the specimen plans are fictitious and are not intended to refer to any surveyor living or dead.

Specimen Plan SP80502:

Add "and Common Property" the description.

In each diagram on the additional sheets, add the words "Common Property" as surrounding information.

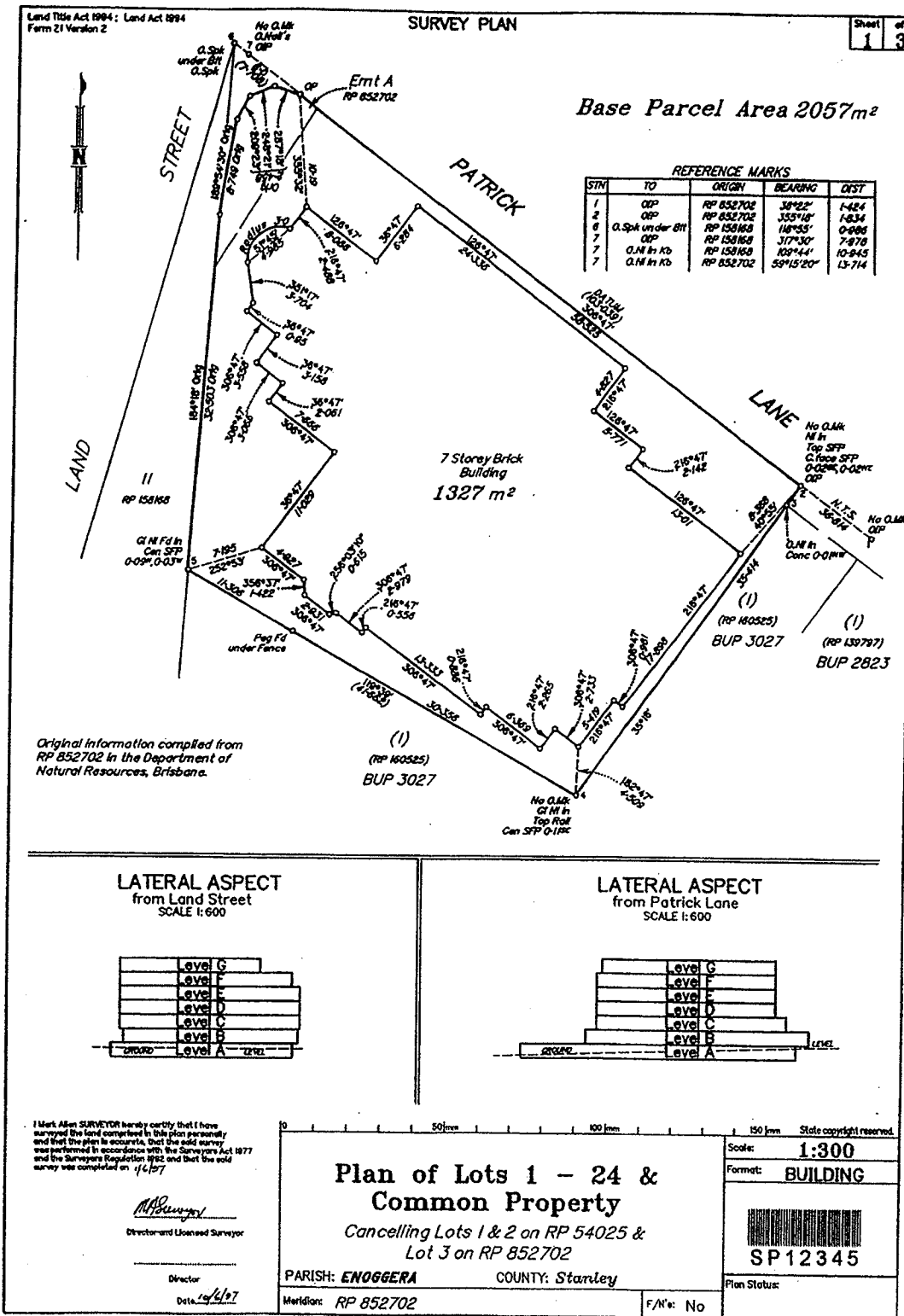

**WARNING : Folded or Mutilated Plans will not be accepted.
Plans may be rolled.
Information may not be placed in the outer margins.**

(Drawing No.)

Registered

Lodged by

(Include address, phone number, reference, and Ledger Code)

1 Certificate of Registered Owners or Lessees.

1/We

Title Reference	Existing		Created		
	Lot	Plan	Lots	Exists	Road
11999099	1	RP 54025	4,5,6,9,12,13,16,19,20	-	-
12004062	2	RP 54025	22-24 & Common Property	-	-
18564003	3	RP 852702	3-18,20,21,23,24 & Common Property	-	-
			1-4,6-8,11,12 & 14-23 & Common Property	-	-

(Names in full)

- as Registered Owners of this land agree to this plan and dedicate the Public Use Land as shown hereon in accordance with Section 50 of the Land Title Act 1994.
- as Lessees of this land agree to this plan.

Signature of Registered Owners & Lessees

* Rule out whichever is inapplicable

2 Local Government Certificate.

I certify that the requirements of this Council, the Local Government Act 1993, the Local Government (Planning and Environment) Act 1990, the City of Brisbane Act 1924, and all Local Laws and Ordinances have been complied with subject to

Alot 21

1-24 & Common Property

Orig	Lot

7. Portion Allocation :

8. Map Reference : CC 103

9. Locality : BRISBANE

10. Local Government : BRISBANE CITY COUNCIL

11. Passed & Endorsed :

By: M. Sweeney
Date: 17/6/97
Signed: M. Sweeney
Designation: Surveyor

12. Building Formal Plans only.
I certify that:
as far as it is practicable to determine, no part of the building shown on this plan encroaches onto adjoining lots or roads.
Part of the building shown on this plan encroaches onto adjoining lots and roads.

Licensed Surveyor/Director
Date: 17/6/97
* Dates verified correct

13. Lodgement Fees :

Survey Deposit	\$	
Lodgement	\$	
..... New Titles	\$	
Photocopy	\$	
Postage	\$	
TOTAL	\$	

14. Plans with Community Management Statement :

CMS Number :

Name : "The Regis"

15. References :

Dept File :

Local Govt :

Surveyor : 94/167

16. Insert Plan Number

SP 12345

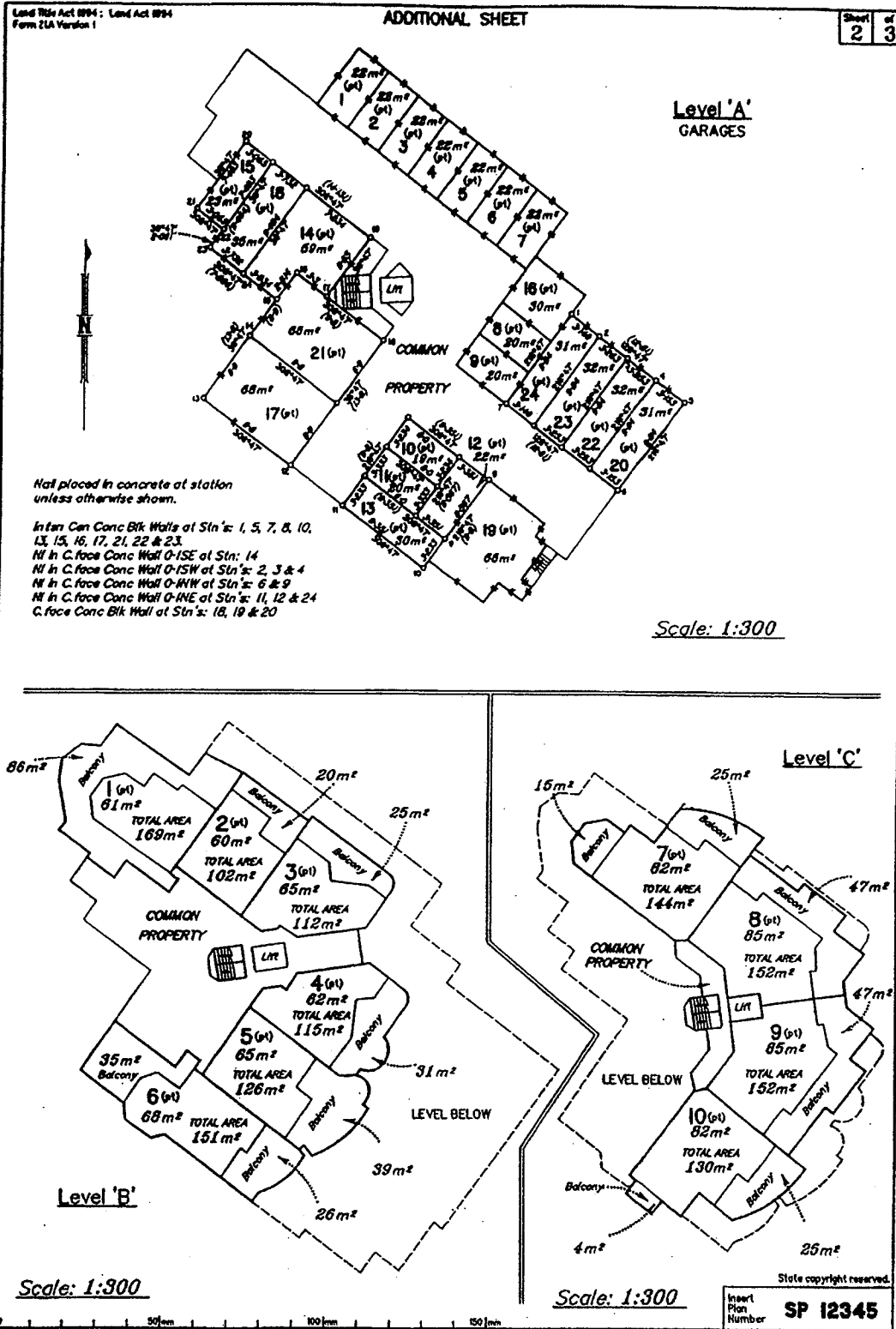

Land Title Act 1994; Land Act 1994
Form 21A Version 1

ADDITIONAL SHEET

Sheet of
3 of
3

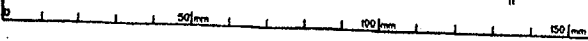
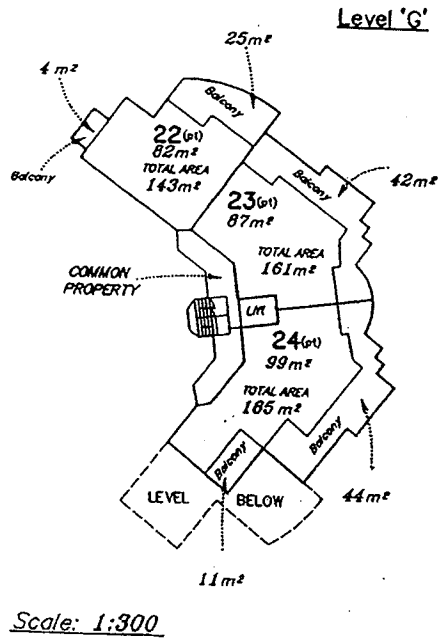
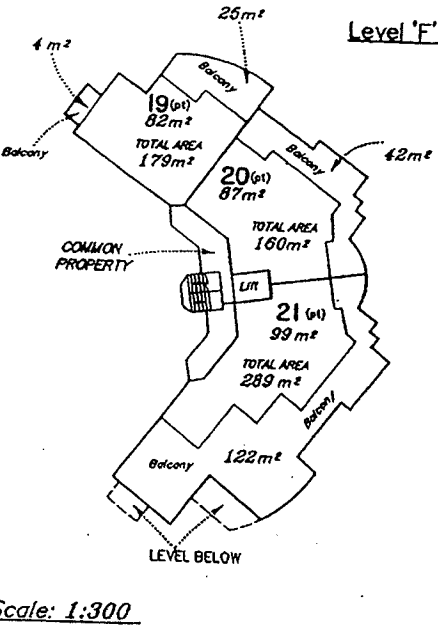
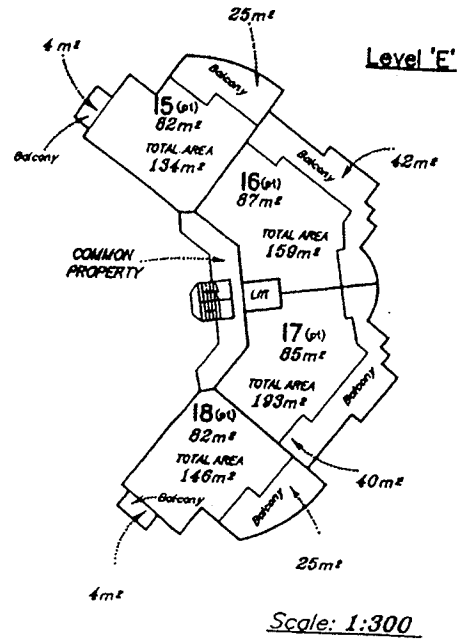
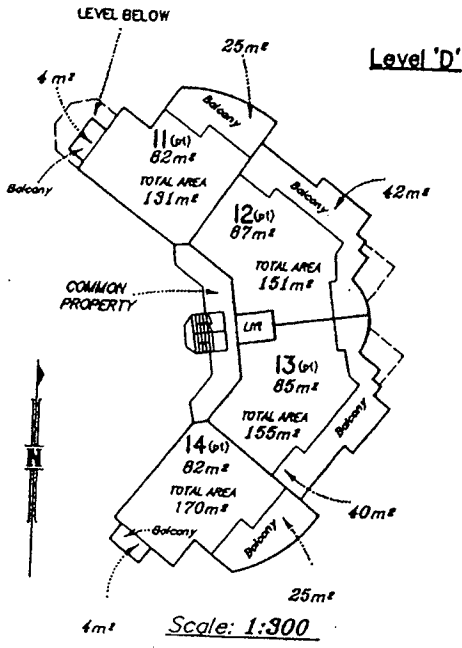

State copyright reserved.
Insert
Plan
Number **SP 12345**

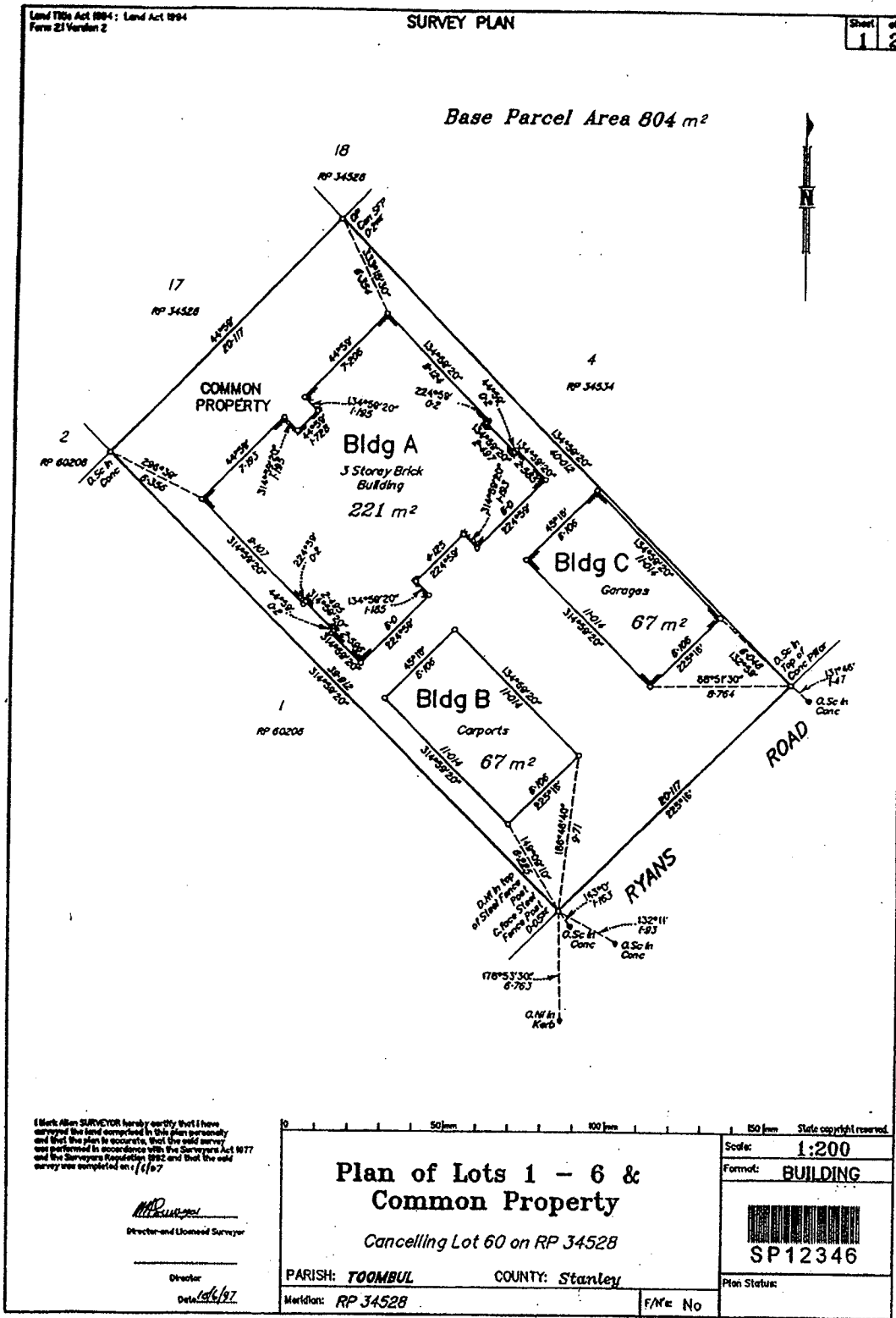

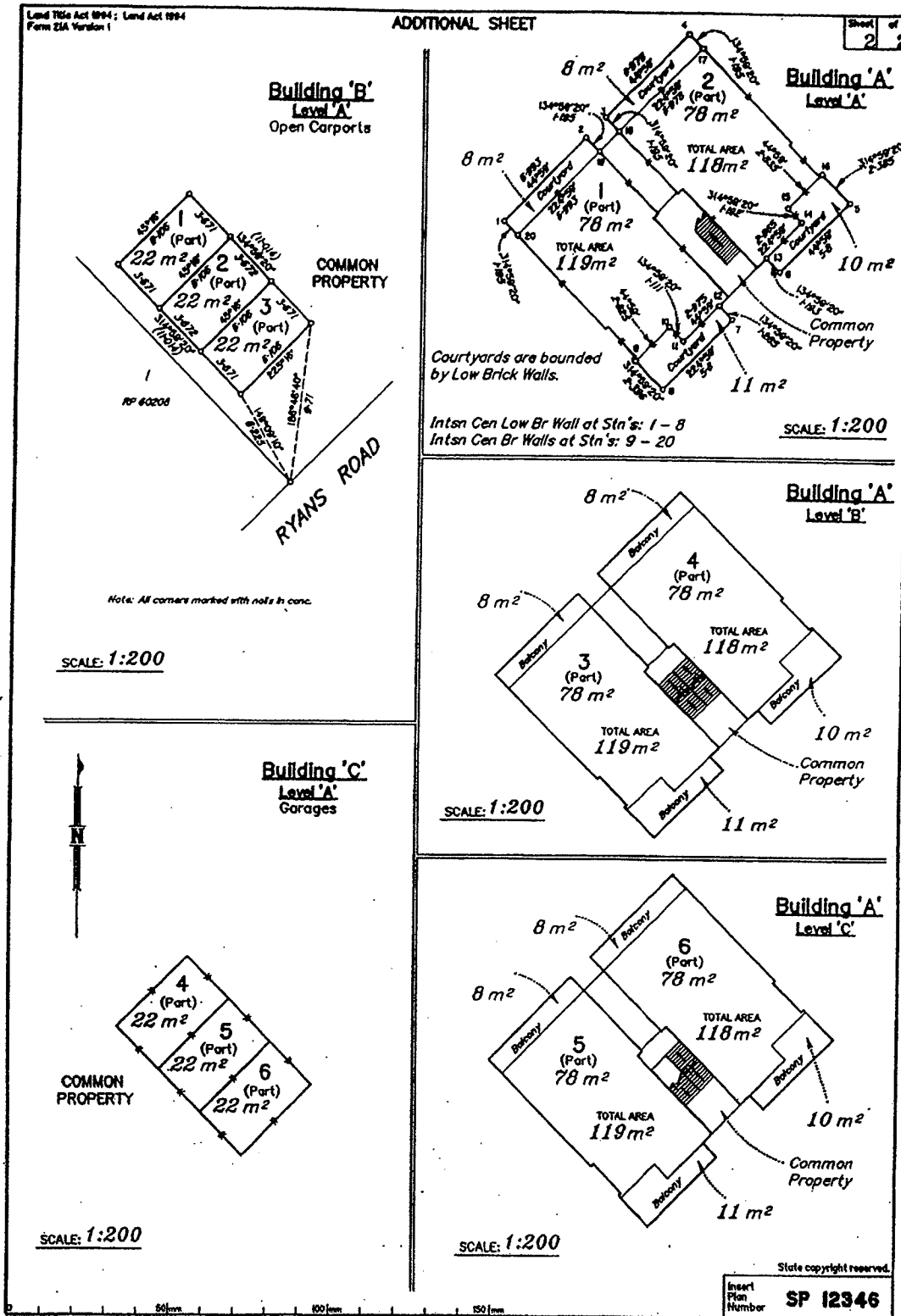

Land Title Act 1984 : Land Act 1994
Form 21 Version 2

SURVEY PLAN

Sheet 1 of 3

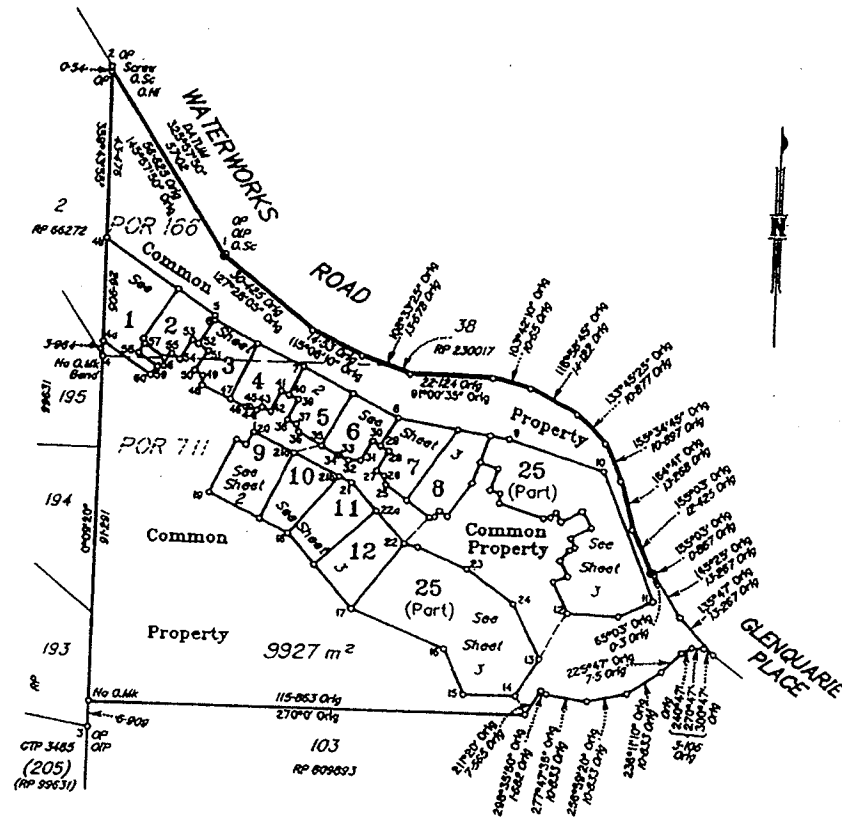

Original information compiled from RP 230017 in the Department of Natural Resources, Brisbane.

SIN	TO	ORIGIN	BEARING	DIST
1	OP	Via IS 89502	34°05'	0.65
1	O.Sc in Rd	Via IS 89502	47°47'20"	0.523
2	O.Nat	Via IS 89502	61°48'40"	3.43
2	O.Sc in Rd	Via RP 230017	34°33'40"	14.82
2	Sc. in Path	Via RP 230017	33°13'30"	20.47
3	OP	Via RP 230017	107°20'	17.96
17	N in Conc		114°47'20"	14.322
21a	N in Conc		114°28'20"	7.34

I Mark Alan SURVEYOR hereby certify that I have surveyed the land represented in this plan personally and that the plan is accurate, that the said survey was performed in accordance with the Surveyors Act 1992 and the Surveyors Regulation 1992 and that the said survey was completed on 14/97

Mark Alan
—Observer and Licensed Surveyor

Director
Date: 10/10/97

0 50m 100m 150m State copyright reserved.

Plan of Lots 1 - 12, 25 & Common Property
Cancelling Lot 35 on RP 230017

Scale: **1:1000**
Format: **STANDARD**

PARISH: **ENOGGERA** COUNTY: **Stanley**

Markings: **RP 230017** F/Nr No

SP12348
Plan Status:

<p>WARNING : Folded or Mutilated Plans will not be accepted. Plans may be rolled. Information may not be placed in the outer margins.</p>																					
<p>(Dedding No.)</p>	<table border="1" style="width:100%; border-collapse: collapse;"> <tr> <td style="width: 50%; vertical-align: top;">Registered</td> <td style="width: 50%; vertical-align: top;">Lodged by</td> </tr> <tr> <td colspan="2" style="text-align: right; font-size: small;">(Include address, phone number, reference, and Ledger Code)</td> </tr> </table>	Registered	Lodged by	(Include address, phone number, reference, and Ledger Code)																	
Registered	Lodged by																				
(Include address, phone number, reference, and Ledger Code)																					
<p>1. Certificate of Registered Owners or Lessees.</p> <p>L/To</p> <p>.....</p> <p>.....</p> <p>(Names in full)</p> <p>* as Registered Owners of this land agree to this plan and dedicate the Public Use Land as shown hereon in accordance with Section 60 of the Land Title Act 1994.</p> <p>* as Lessees of this land agree to this plan.</p> <p>Signature of * Registered Owners * Lessees</p> <p>.....</p> <p>.....</p> <p>.....</p> <p>* Note out whichever is applicable</p>																					
<p>2. Local Government Certificate.</p> <p>*</p> <p>certifies that the requirements of this Council, the Local Government Act 1993, the Local Government (Planning and Environment) Act 1990, the City of Brisbane Act 1924, and all local laws and Ordinances have been complied with subject to</p> <p>.....</p> <p>.....</p> <p>.....</p> <p>Dated this day of</p> <p>.....</p> <p>.....</p> <p>.....</p> <p>* Insert the name of the Local Government. * Insert designation of signatory or delegation.</p>																					
<p>3. Plans with Community Management Statement :</p> <p>CMS Number :</p> <p>Name : "Grandview Heights"</p>	<p>4. References :</p> <p>Dept File :</p> <p>Local Govt :</p> <p>Surveyor : 96/138</p>																				
<table border="1" style="width:100%; border-collapse: collapse;"> <tr> <td colspan="2" style="text-align: center;">Existing</td> <td colspan="3" style="text-align: center;">Created</td> </tr> <tr> <td style="font-size: small;">Title Reference</td> <td style="font-size: small;">Lot</td> <td style="font-size: small;">Plan</td> <td style="font-size: small;">Lots</td> <td style="font-size: small;">Estate</td> <td style="font-size: small;">Road</td> </tr> <tr> <td>50131165</td> <td>35</td> <td>RP 230017</td> <td>1-12, 25 & Common Property</td> <td>-</td> <td>-</td> </tr> </table>		Existing		Created			Title Reference	Lot	Plan	Lots	Estate	Road	50131165	35	RP 230017	1-12, 25 & Common Property	-	-			
Existing		Created																			
Title Reference	Lot	Plan	Lots	Estate	Road																
50131165	35	RP 230017	1-12, 25 & Common Property	-	-																
<p>166 1, 3-12, 25 & Common Property</p> <p>711 1-4 & Common Property</p> <table border="1" style="width:100%; border-collapse: collapse;"> <tr> <td style="font-size: small;">Orig</td> <td style="font-size: small;">Lots</td> </tr> <tr> <td>7. Portion Allocation :</td> <td></td> </tr> <tr> <td>8. Map Reference :</td> <td>CC 98</td> </tr> <tr> <td>9. Locality :</td> <td>ASHGROVE</td> </tr> <tr> <td>10. Local Government :</td> <td>BRISBANE CITY COUNCIL</td> </tr> <tr> <td>11. Passed & Endorsed :</td> <td></td> </tr> <tr> <td>By : <i>MA SOMMEYER</i></td> <td></td> </tr> <tr> <td>Date : <i>10/6/97</i></td> <td></td> </tr> <tr> <td>Signed : <i>MA Sommeyer</i></td> <td></td> </tr> <tr> <td>Designation : <i>Deputy Registrar</i></td> <td></td> </tr> </table>		Orig	Lots	7. Portion Allocation :		8. Map Reference :	CC 98	9. Locality :	ASHGROVE	10. Local Government :	BRISBANE CITY COUNCIL	11. Passed & Endorsed :		By : <i>MA SOMMEYER</i>		Date : <i>10/6/97</i>		Signed : <i>MA Sommeyer</i>		Designation : <i>Deputy Registrar</i>	
Orig	Lots																				
7. Portion Allocation :																					
8. Map Reference :	CC 98																				
9. Locality :	ASHGROVE																				
10. Local Government :	BRISBANE CITY COUNCIL																				
11. Passed & Endorsed :																					
By : <i>MA SOMMEYER</i>																					
Date : <i>10/6/97</i>																					
Signed : <i>MA Sommeyer</i>																					
Designation : <i>Deputy Registrar</i>																					
<p>12. Building Format Plans only.</p> <p>I certify that :</p> <p>* As far as it is practical to determine, no part of the building shown on this plan encroaches onto adjoining lots or road.</p> <p>* Part of the building shown on this plan encroaches onto adjoining * lots and road.</p> <p>Licensed Surveyor/Director * Date</p> <p>* date written/typed</p>																					
<p>13. Lodgement Fees :</p> <p>Survey Deposit \$</p> <p>Lodgement \$</p> <p>..... New Titles \$</p> <p>Photocopy \$</p> <p>Postage \$</p> <p>TOTAL \$</p>																					
<p>14. Insert Plan Number</p> <p style="text-align: right; font-size: large;">SP 12348</p>																					

Land Title Act 1994: Land Act 1994
Form 21A Version 1

ADDITIONAL SHEET

Sheet 2 of 3

REFERENCE MARKS				
STN	TO	ORIGIN	BEARING	DIST
21a	M in Conc		114°28'20"	7.34

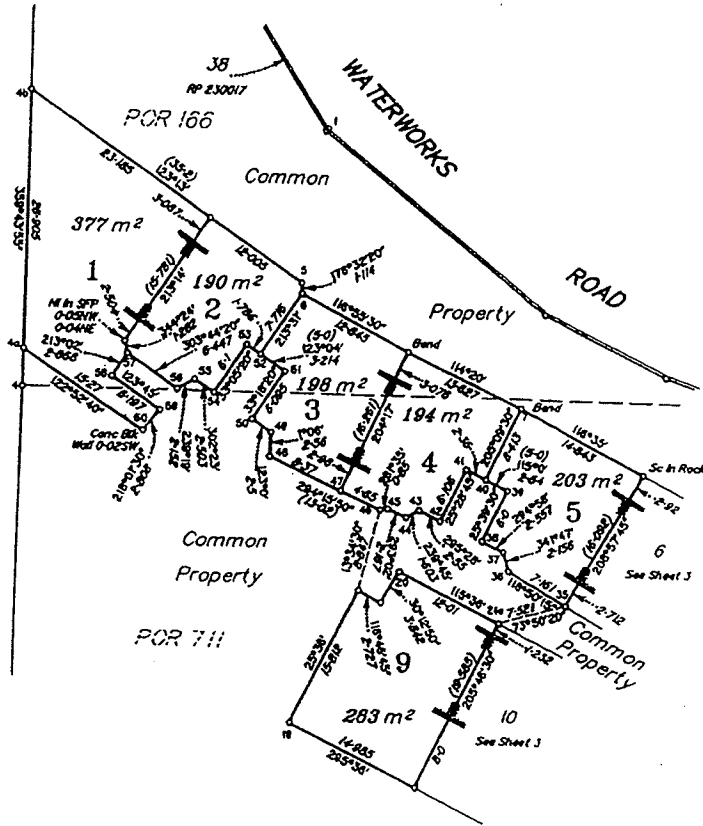

Nail in Conc at stn's: - 20, 21a & 34 - 60

— Indicates junction of face of brick wall & centreline of internal wall.

Pegs placed at all new corners unless noted otherwise.

SCALE: 1:400

State copyright reserved.

Insert Plan Number **SP 12348**

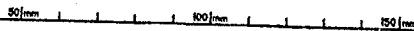

Land Title Act 1994 : Land Act 1994
Form 21 Version 2

SURVEY PLAN

Sheet 1 of 4

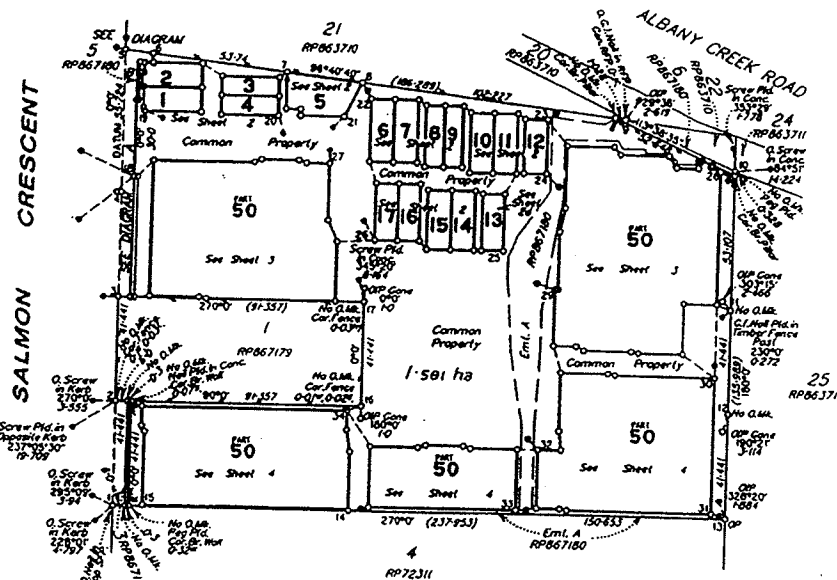
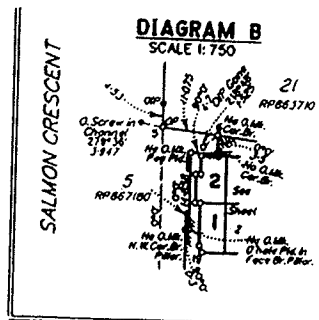
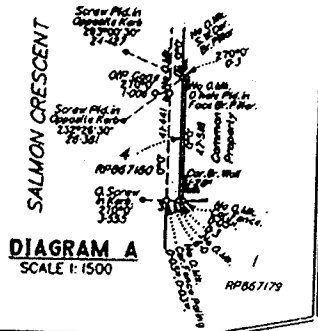

Peg placed at all new corners unless otherwise shown.

I, John Ross SURVEYOR, Licensed Surveyor, hereby certify that I have surveyed the land comprised in this plan personally, that the plan is accurate, that the said survey was performed in accordance with the Surveyors Act 1977 and the Surveyors Regulations 1992 and that the said survey was completed on 30-5-97.

John Ross
Date: 18/5/97
Licensed Surveyor

PLAN OF Lots 1 to 17, 50 and Common Property Cancelling Lot 2 on RP867180.		Scale: 1:1500 Format: STANDARD
PARISH: KEDRON COUNTY: Stanley		 SP80500
Meridian: of RP867180.	F/A: No	Plan Status:

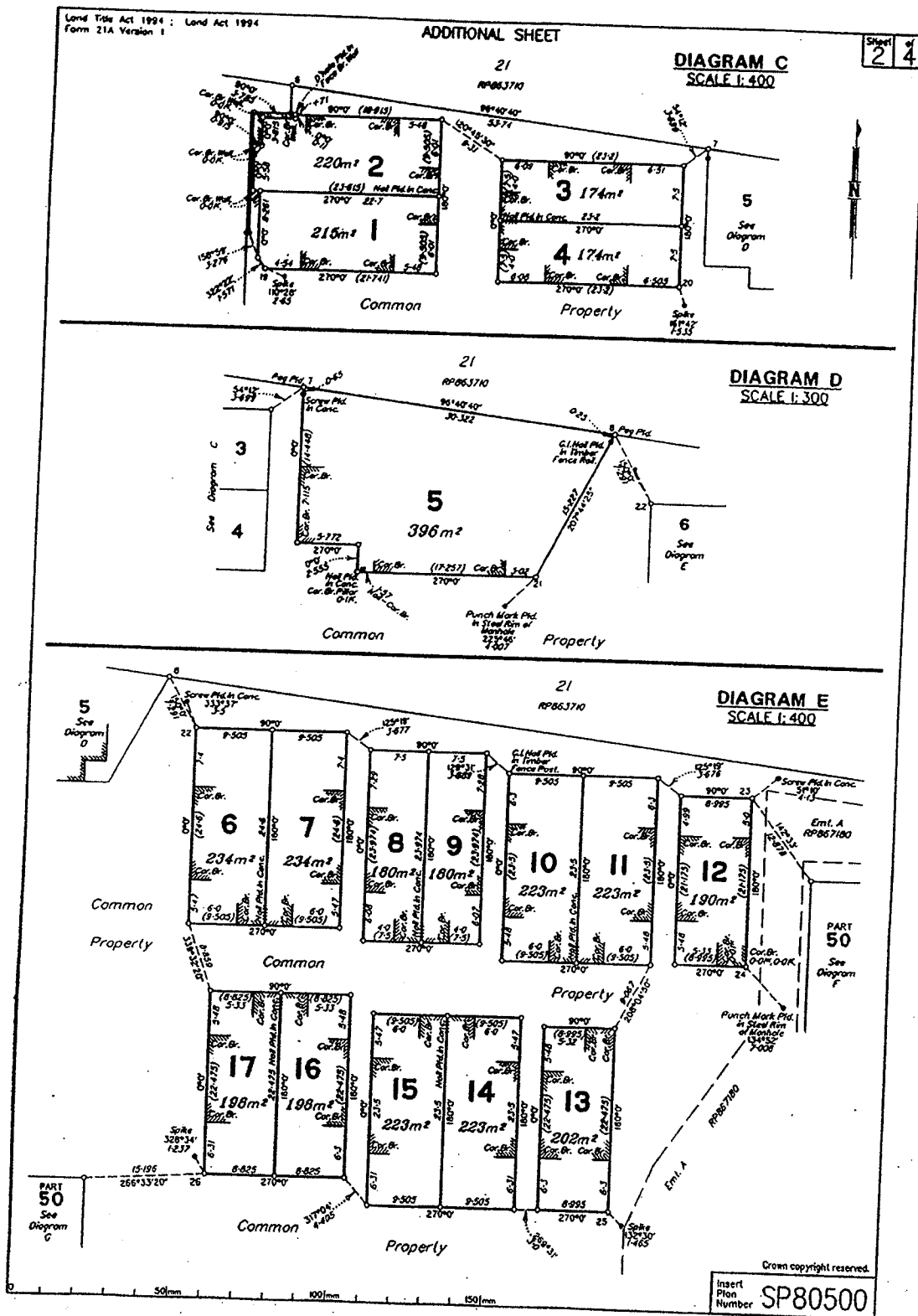

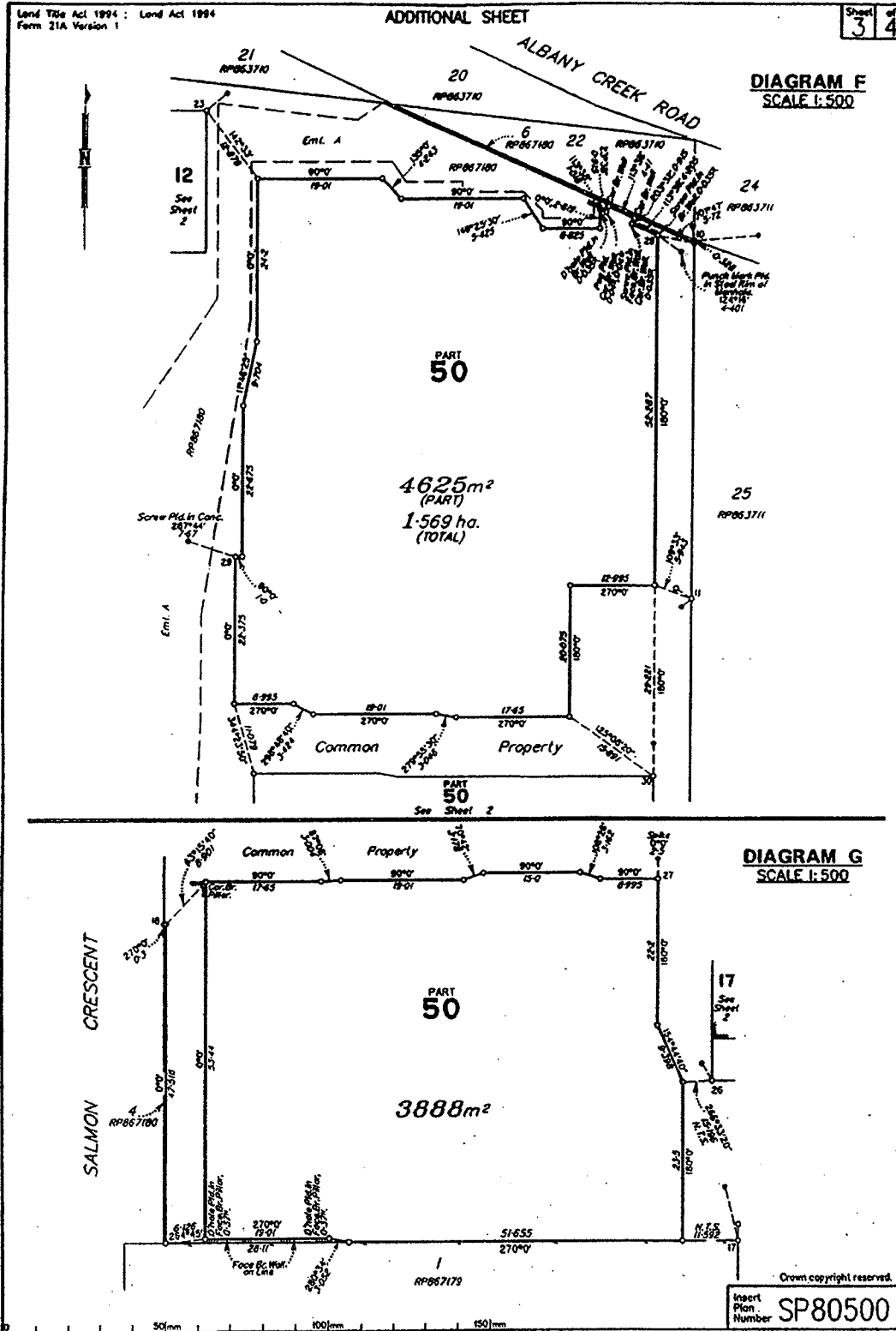

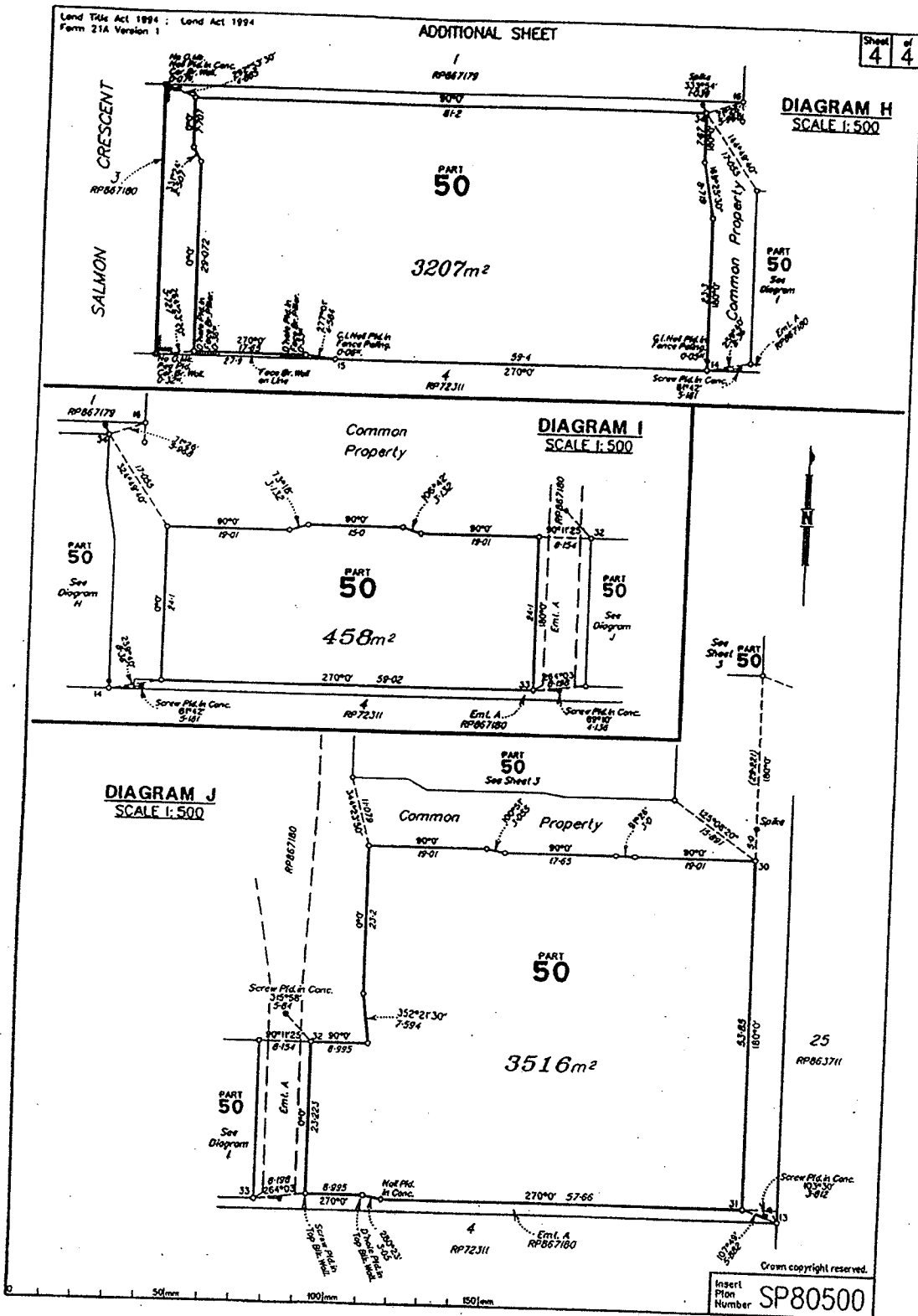

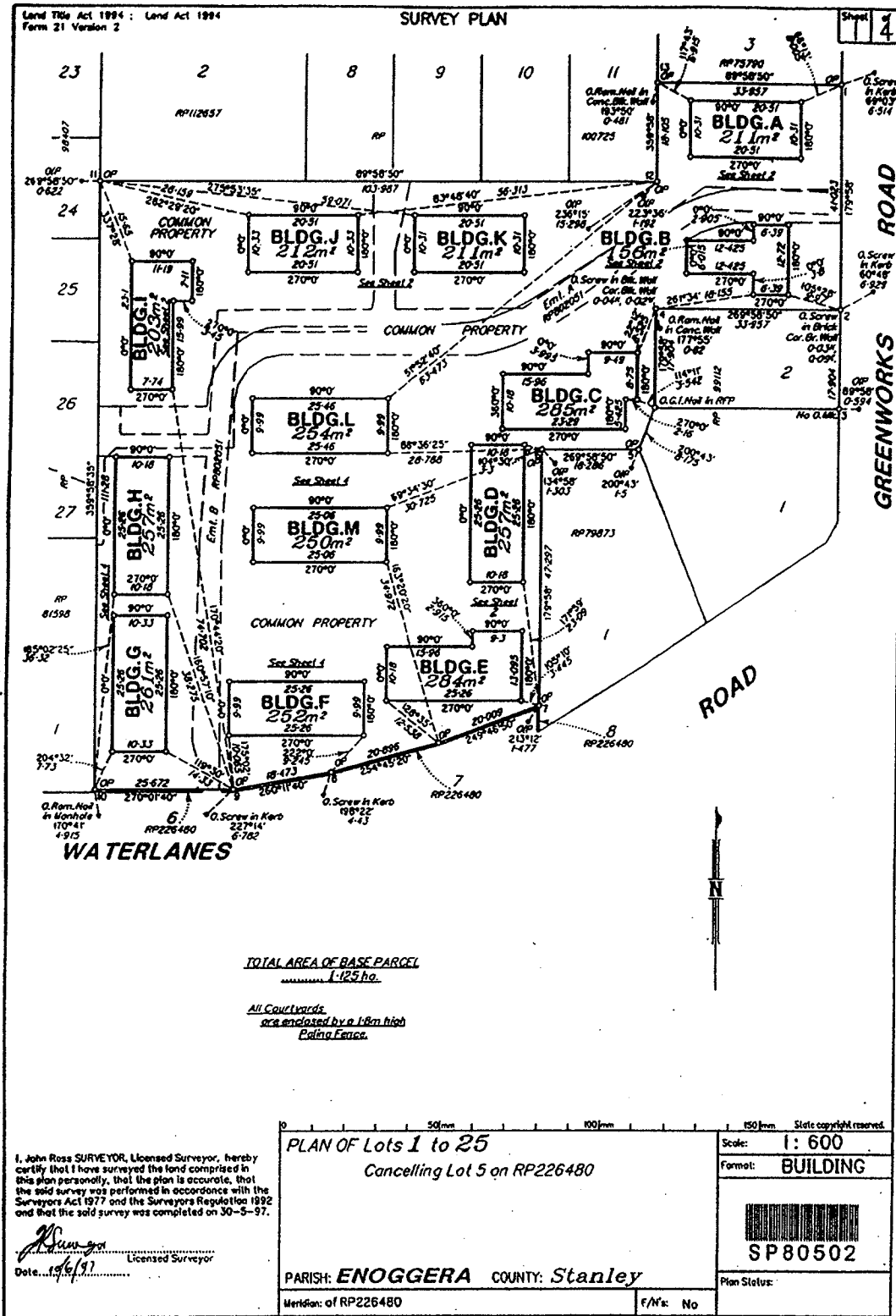

<p>WARNING: Folded or Marked Plans will not be accepted. Plans may be rolled. Information may not be placed in the outer margins.</p>																									
<p>(Dealing No.)</p>	<p>Registered</p> <p style="text-align: right;">5. Lodged by</p> <p style="text-align: right; font-size: small;">(include address, phone number, reference, and Lodger Code)</p>																								
<p>1. Certificate of Registered Owners or Lessees.</p>																									
<p>I/We</p> <p>.....</p> <p>.....</p> <p>(Names in full)</p> <p>has Registered Owners of this land agree to this plan and dedicate the Public Use Land as shown hereon in accordance with Section 50 of the Land Title Act 1994.</p> <p>has Lessees of this land agree to this plan.</p> <p>Signature of *Registered Owners *Lessees</p> <p>.....</p> <p>.....</p> <p>* Rule out whichever is inapplicable</p>																									
<p>2. Local Government Certificate.</p> <p>.....</p> <p>certifies that the requirements of this Council, the Local Government Act 1993, the Local Government (Planning and Environment) Act 1990, the City of Brisbane Act 1924, and all Local Laws and Ordinances have been complied with subject to</p> <p>.....</p> <p>.....</p> <p>.....</p> <p>Dated this day of</p> <p>.....</p> <p>.....</p> <p>* Insert the name of the Local Government. # Insert designation of signatory or delegation</p>																									
<p>3. Plans with Community Management Statement:</p> <p>CMS Number:</p> <p>Name: Moresby Hills</p>	<p>4. References:</p> <p>Dept File:</p> <p>Local Govt:</p> <p>Surveyor: 00563903</p>																								
<p>6. Existing</p> <table border="1" style="width:100%; border-collapse: collapse;"> <thead> <tr> <th>Title Reference</th> <th>Lot</th> <th>Plan</th> <th colspan="3">Created</th> </tr> <tr> <th></th> <th></th> <th></th> <th>Lots</th> <th>Emts</th> <th>Road</th> </tr> </thead> <tbody> <tr> <td style="text-align: center;">245</td> <td></td> <td style="text-align: center;">1-25</td> <td></td> <td></td> <td></td> </tr> <tr> <td style="text-align: center;">Orig</td> <td></td> <td style="text-align: center;">Lots</td> <td></td> <td></td> <td></td> </tr> </tbody> </table> <p>7. Partion Allocation:</p> <p>8. Map Reference: 9443-224</p> <p>9. Locality: CHERMSIDE</p> <p>10. Local Government: BRISBANE CITY COUNCIL</p> <p>11. Passed & Endorsed:</p> <p>By: John Ross SURVEYOR</p> <p>Date: 10/6/07</p> <p>Signed: <i>[Signature]</i></p> <p>Designation: <i>[Signature]</i></p>		Title Reference	Lot	Plan	Created						Lots	Emts	Road	245		1-25				Orig		Lots			
Title Reference	Lot	Plan	Created																						
			Lots	Emts	Road																				
245		1-25																							
Orig		Lots																							
<p>12. Building Formol Plans only.</p> <p>I certify that:</p> <p>*As far as it is practical to determine, no part of the building shown on this plan encroaches onto adjoining lots or road;</p> <p>*Part of the building shown on this plan encroaches onto adjoining *lots and road</p> <p><i>[Signature]</i> 10/6/07</p> <p>Licensed Surveyor/Director* Date</p> <p>*delete words not required</p>																									
<p>13. Lodgement Fees:</p> <p>Survey Deposit \$</p> <p>Lodgement \$</p> <p>___New Titles \$</p> <p>Photocopy \$</p> <p>Postage \$</p> <p>TOTAL \$</p>																									
<p>14. Insert Plan Number</p> <p style="text-align: right; font-size: large;">SP80502</p>																									

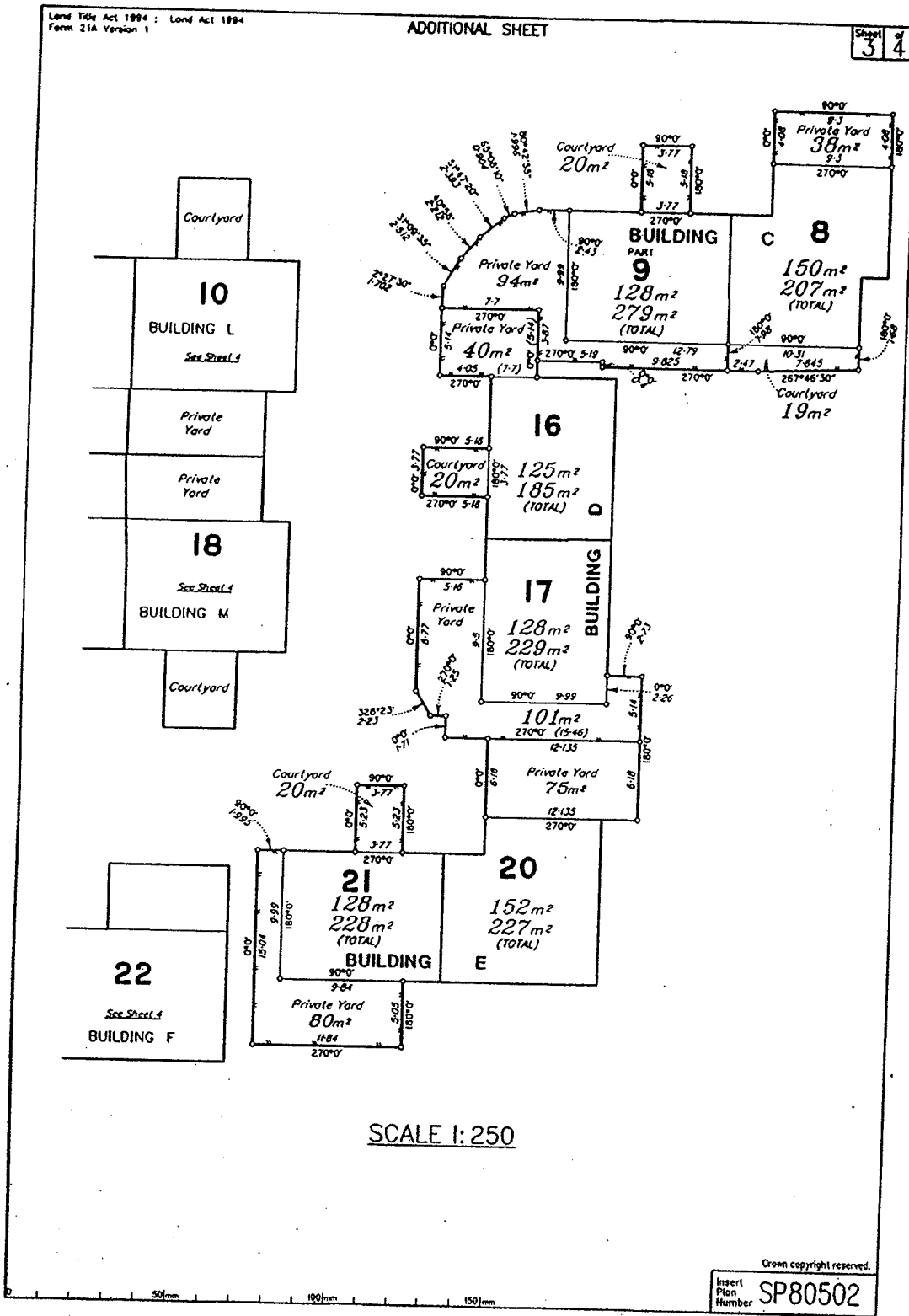

Land Title Act 1994 : Land Act 1994
Form 21A Version 1

ADDITIONAL SHEET

Sheet of
44

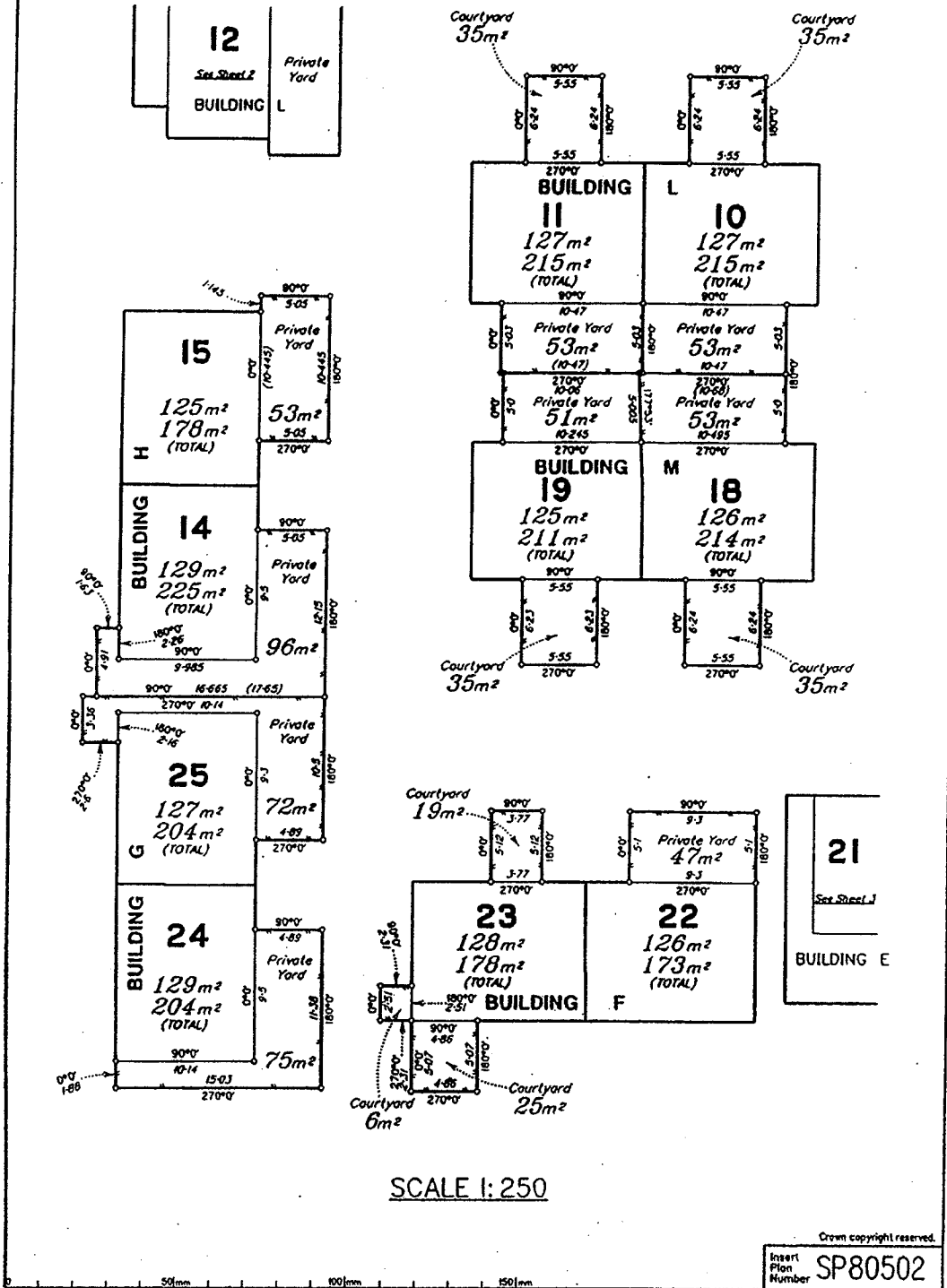

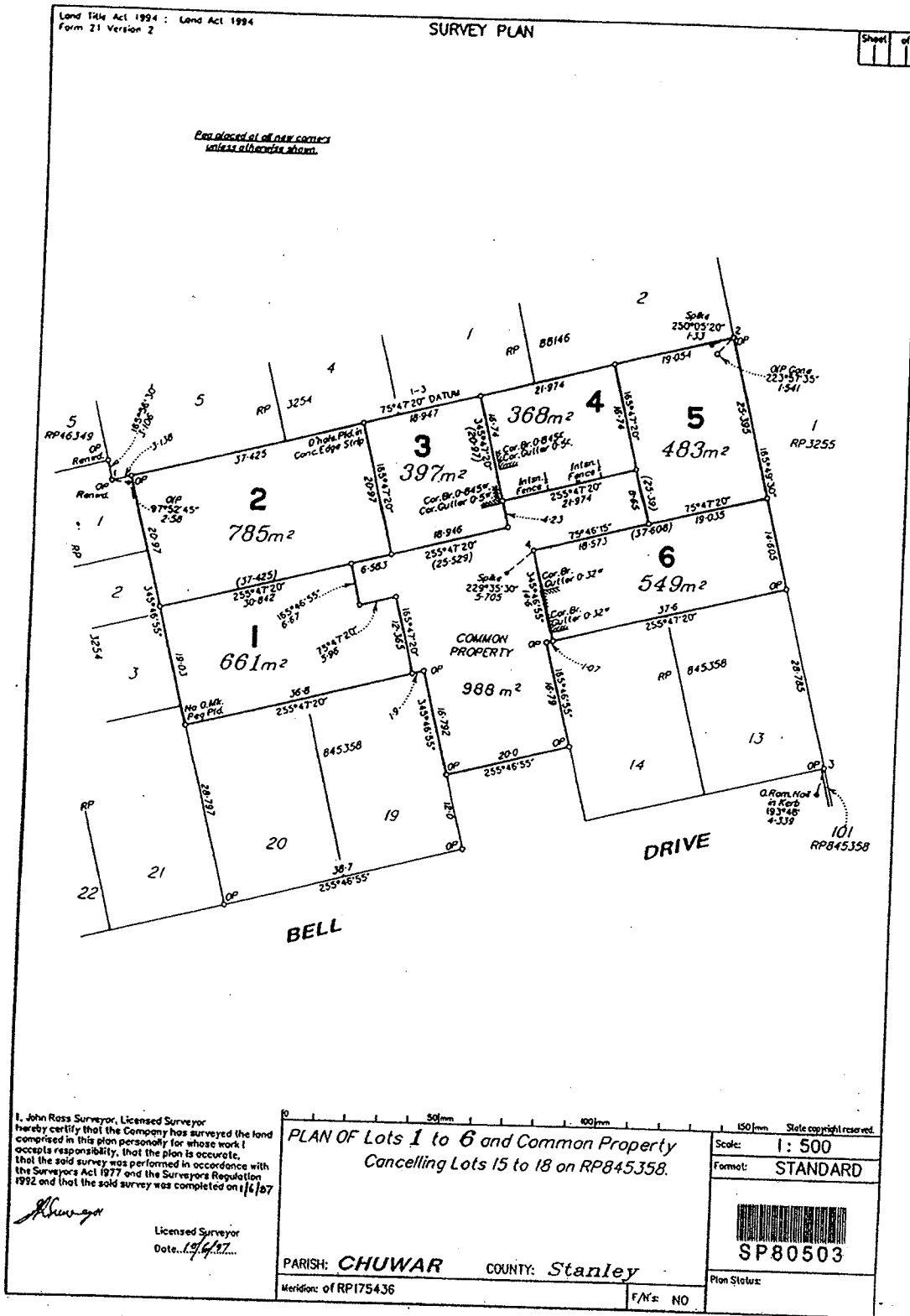

<p>WARNING: Folded or Marketed Plans will not be accepted. Plans may be rolled. Information may not be placed in the outer margins.</p>																									
<p>(Dealing No.)</p>	<table border="1" style="width:100%; border-collapse: collapse;"> <tr> <td style="width: 50%; vertical-align: top;">Registered</td> <td style="width: 50%; vertical-align: top;">3. Lodged by</td> </tr> <tr> <td colspan="2" style="text-align: right; font-size: small;">(Include address, phone number, reference, and Lodger Code)</td> </tr> </table>	Registered	3. Lodged by	(Include address, phone number, reference, and Lodger Code)																					
Registered	3. Lodged by																								
(Include address, phone number, reference, and Lodger Code)																									
<p>1. Certificate of Registered Owners or Lessees.</p> <p>I/We</p> <p>.....</p> <p>.....</p> <p>(Names in full)</p> <p>*as Registered Owners of this land agree to this plan and dedicate the Public Use Land as shown hereon in accordance with Section 50 of the Land Title Act 1994.</p> <p>*as Lessees of this land agree to this plan.</p> <p>Signature of *Registered Owners *Lessees</p> <p>.....</p> <p>.....</p> <p>* Ruls out whichever is inapplicable</p>																									
<p>2. Local Government Certificate.</p> <p>.....</p> <p>certifies that the requirements of this Council, the Local Government Act 1993, the Local Government (Planning and Environment) Act 1990, the City of Brisbane Act 1924, and all Local Laws and Ordinances have been complied with subject to</p> <p>.....</p> <p>.....</p> <p>Dated this day of</p> <p>.....</p> <p>.....</p> <p>* Insert the name of the Local Government. # Insert designation of signatory or delegation</p>																									
<p>3. Plans with Community Management Statement:</p> <p>CMS Number:</p> <p>Name: Raboul Palms</p>	<p>4. References:</p> <p>Dept File:</p> <p>Local Govt:</p> <p>Surveyor: 00563904</p>																								
<p>6. Existing</p> <table border="1" style="width:100%; border-collapse: collapse;"> <thead> <tr> <th>Title Reference</th> <th>Lot</th> <th>Plan</th> <th colspan="3">Created</th> </tr> <tr> <th></th> <th></th> <th></th> <th>Lots</th> <th>Emis</th> <th>Road</th> </tr> </thead> <tbody> <tr> <td> </td> <td> </td> <td> </td> <td> </td> <td> </td> <td> </td> </tr> <tr> <td> </td> <td> </td> <td> </td> <td> </td> <td> </td> <td> </td> </tr> </tbody> </table>		Title Reference	Lot	Plan	Created						Lots	Emis	Road												
Title Reference	Lot	Plan	Created																						
			Lots	Emis	Road																				
<p>7. Portion Allocation:</p> <p>8. Map Reference: CC97</p> <p>9. Locality: BRIGHTON</p> <p>10. Local Government: BRISBANE CITY COUNCIL</p> <p>11. Passed & Endorsed:</p> <p>By: John Ross SURVEYOR</p> <p>Date: 10/6/07</p> <p>Signed: <i>J.R. Ross</i></p> <p>Designation: <i>Surveyor</i></p>																									
<p>12. Building Formal Plans only.</p> <p>I certify that:</p> <p>*As far as it is practical to determine, no part of the building shown on this plan encroaches onto adjoining lots or road;</p> <p>* Part of the building shown on this plan encroaches onto adjoining *lots and road</p> <p>Licensed Surveyor/Director * Date</p> <p>*delete words not required</p>																									
<p>13. Lodgement Fees:</p> <table border="1" style="width:100%; border-collapse: collapse;"> <tr> <td>Survey Deposit</td> <td>\$</td> </tr> <tr> <td>Lodgement</td> <td>\$</td> </tr> <tr> <td>___New Titles</td> <td>\$</td> </tr> <tr> <td>Photocopy</td> <td>\$</td> </tr> <tr> <td>Postage</td> <td>\$</td> </tr> <tr> <td>TOTAL</td> <td>\$</td> </tr> </table>		Survey Deposit	\$	Lodgement	\$	___New Titles	\$	Photocopy	\$	Postage	\$	TOTAL	\$												
Survey Deposit	\$																								
Lodgement	\$																								
___New Titles	\$																								
Photocopy	\$																								
Postage	\$																								
TOTAL	\$																								
<p>14. Insert Plan Number: SP80503</p>																									

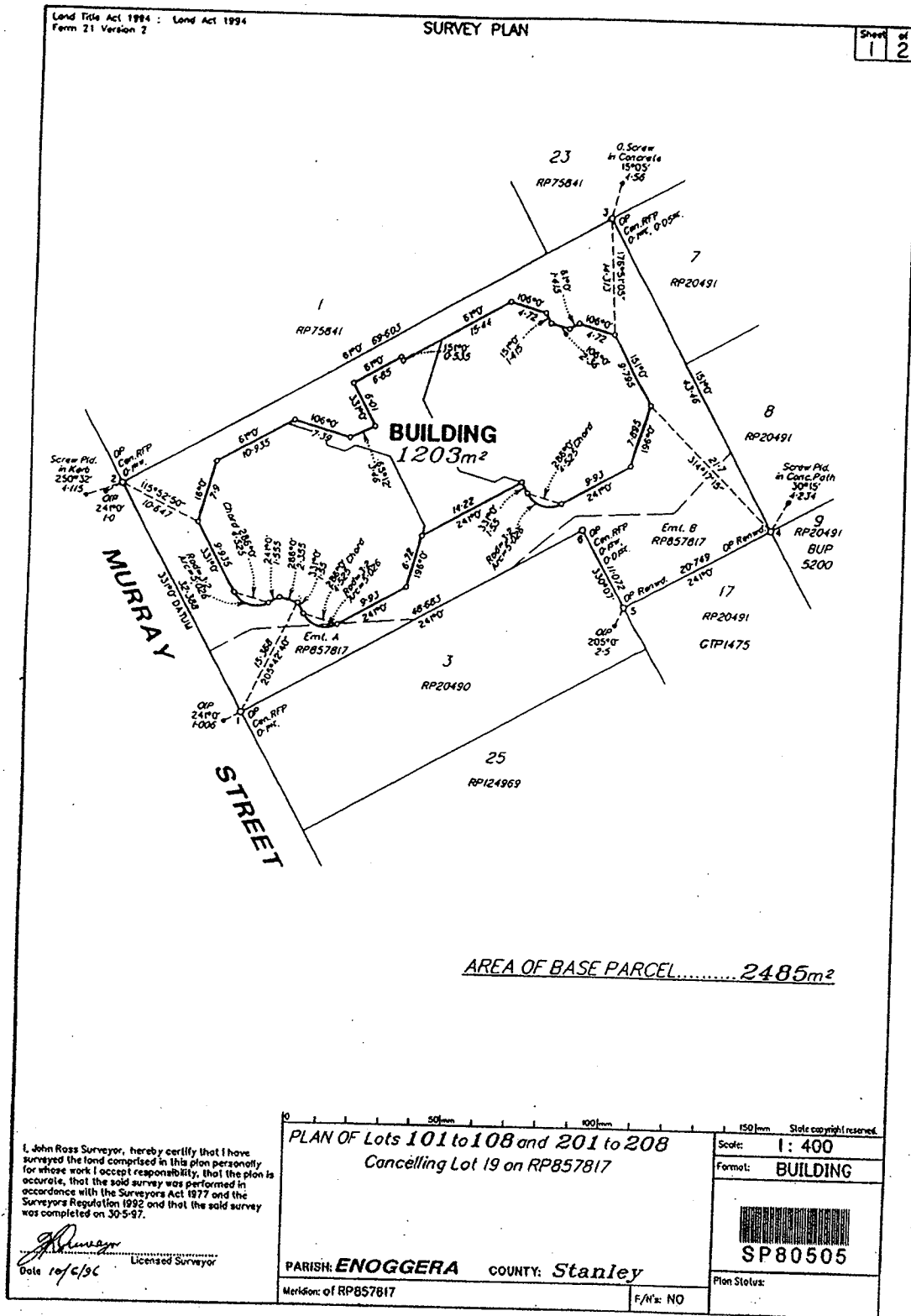

(Dealing No.)	WARNING: Folded or Marked Plans will not be accepted. Plans may be rolled. Information may not be placed in the outer margins.												
	Registered _____ 5. Lodged by _____ (Include address, phone number, reference, and Ledger Code)												
1. Certificate of Registered Owners or Lessees. I/We _____ (Names in full) *as Registered Owners of this land agree to this plan and dedicate the Public Use Land as shown hereon in accordance with Section 50 of the Land Title Act 1994. *as Lessees of this land agree to this plan. Signature of *Registered Owners #Lessees _____ * Rule out whichever is inapplicable	6. Existing _____ Created _____ <table border="1" style="width:100%; border-collapse: collapse;"> <thead> <tr> <th>Title Reference</th> <th>Lot</th> <th>Plan</th> <th>Lot</th> <th>Emile</th> <th>Road</th> </tr> </thead> <tbody> <tr> <td> </td> <td> </td> <td> </td> <td> </td> <td> </td> <td> </td> </tr> </tbody> </table>	Title Reference	Lot	Plan	Lot	Emile	Road						
Title Reference	Lot	Plan	Lot	Emile	Road								
2. Local Government Certificate. certifies that the requirements of this Council, the Local Government Act 1993, the Local Government (Planning and Environment) Act 1990, the City of Brisbane Act 1924, and all Local Laws and Ordinances have been complied with subject to	12. Building Formol Plans only. I certify that: *As far as it is practical to determine, no part of the building shown on this plan encroaches onto adjoining lots or road; * Part of the building shown on this plan encroaches onto adjoining lots and road. _____ 28/6/87 Licensed Surveyor/Director Date *delete words not required												
Dated this _____ day of _____ # _____ # _____ * Insert the name of the Local Government. # Insert designation of signatory or delegation	For 18G 1-17, 50 Orig _____ Lots _____ 7. Portion Allocation: _____ 8. Map Reference: 9542-11223 9. Locality: TOOWONG 10. Local Government: BRISBANE CITY COUNCIL 11. Passed & Endorsed: By: John Ross SURVEYOR Date: 10/6/87 Signed: _____ Designation: _____												
3. Plans with Community Management Statement: CMS Number: Name: HAGEN TOWERS	4. References: Dept File: Local Govt: Surveyor: 00563902 13. Lodgement Fees: Survey Deposit \$ _____ Lodgement \$ _____ ___New Titles \$ _____ Photocopy \$ _____ Postage \$ _____ TOTAL \$ _____ 14. Insert Plan Number SP80505												

Land Title Act 1994 : Land Act 1994
Form Z1A Version 1

ADDITIONAL SHEET

Sheet of
2 2

DIAGRAM C
LEVEL C
SCALE 1:300

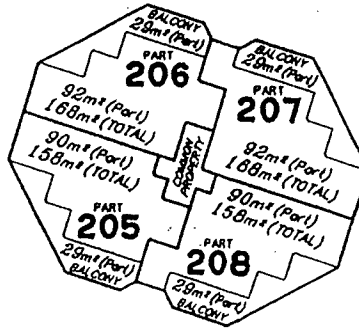
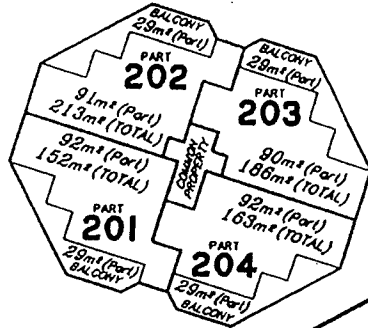

DIAGRAM B
LEVEL B
SCALE 1:300

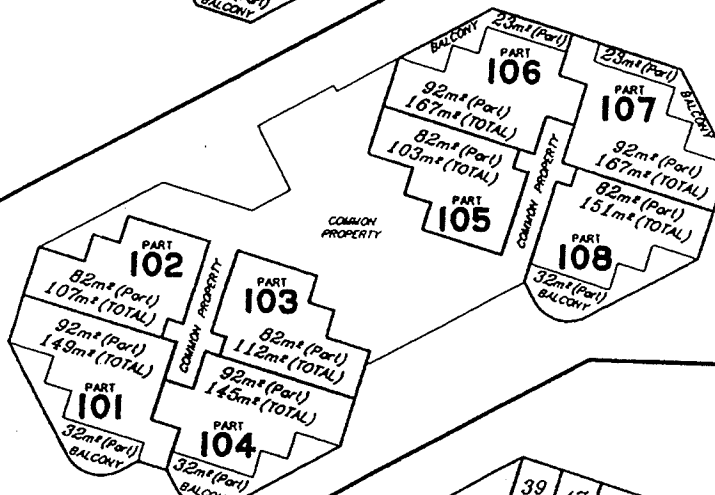
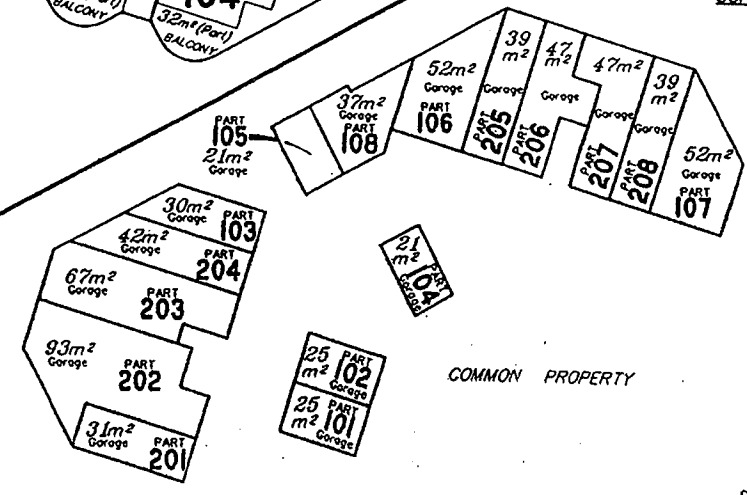

DIAGRAM A
LEVEL A
SCALE 1:300



Drawn copyright reserved.

Insert Plan Number **SP80505**

50mm 100mm 150mm

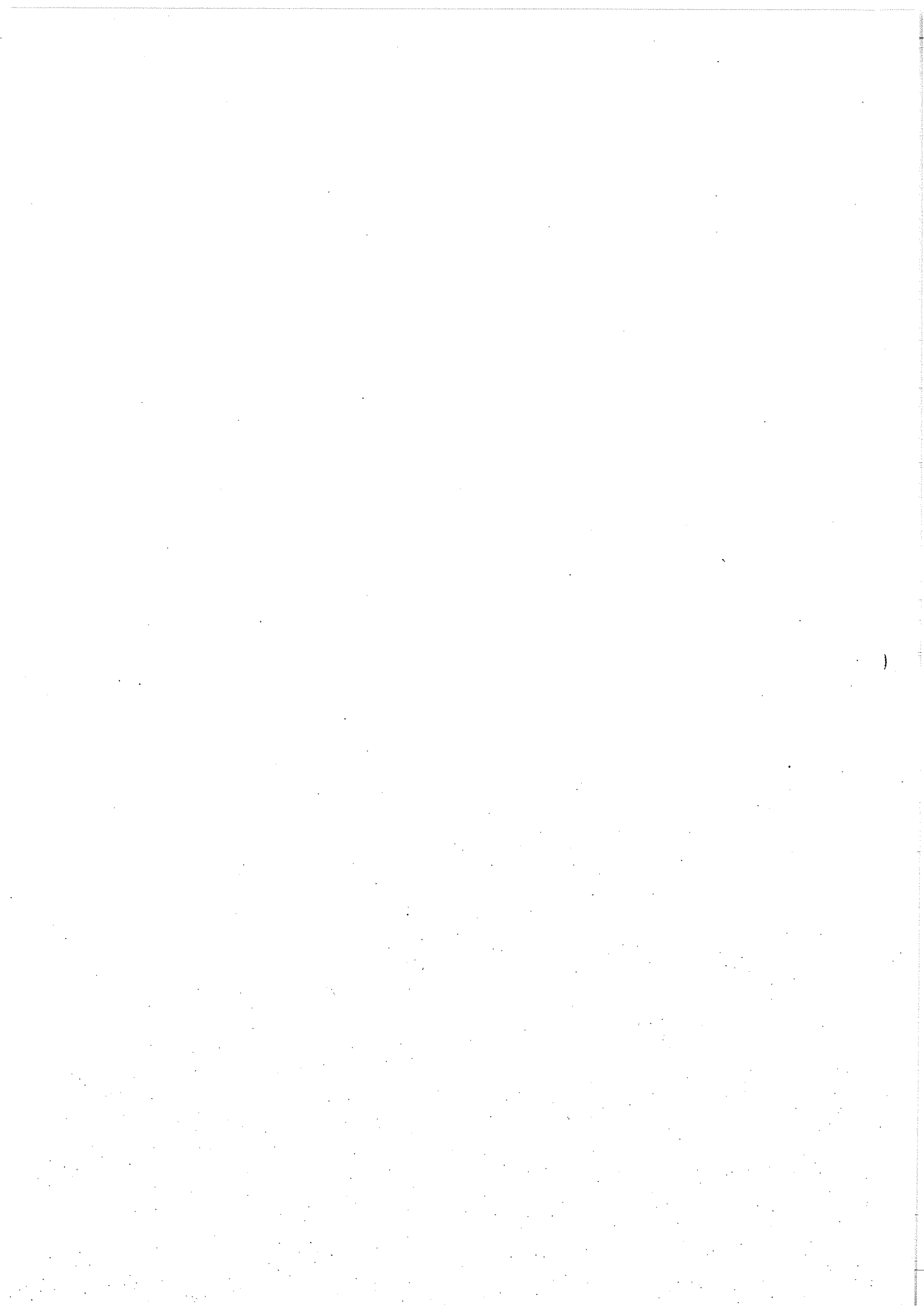

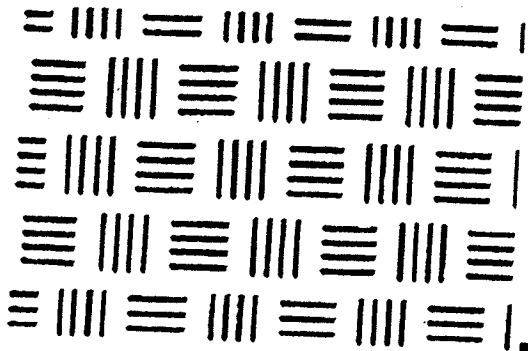

Part E4

Department of Mines and Energy Requirements

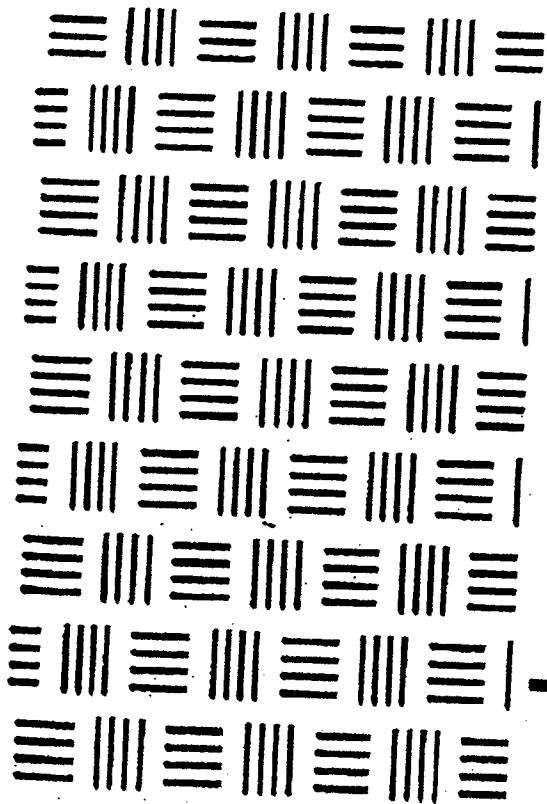

Outlining the requirements as set down by
the Department of Mines and Energy.

Department of Mines & Energy

**G.P.O. BOX 194
BRISBANE QLD 4001**

Phone: 3237 1601

Fax: 3237 1634

Att: Chief Surveyor

IMPORTANT NOTE

Should a conflict arise between these Guidelines and various Acts and Regulations referred to, then the provisions of those Acts and Regulations will prevail. The Guidelines shall not be taken as a substitute for detailed professional advice.

© Copyright Reserved

Guidelines or parts hereof must not be reproduced without permission

Guidelines

Mines and Energy Surveys

The following guidelines are produced by the Survey Group of the Department of Mines and Energy as a guide to the survey requirements for actions effected under Acts administered by the Department.

Should a conflict arise between these Guidelines and the Mineral Resources Act 1989 and Regulations 1990 or the Petroleum Act 1923 and Petroleum Regulations (Land) 1966 or other mining legislation then the provisions of those Acts and Regulations will prevail.

TERMS

The abbreviations of the more common references are shown hereunder:

The Act:	Mineral Resources Act 1989
Regulations:	The Mineral Resources Regulations 1990
Section Sec. or Part:	Section or Part in the Mineral Resources
Act 1989	
Surveyors Act:	The Surveyors Act 1977
Surveyors Regulations:	The Surveyors Regulations 1992
Petroleum Act:	The Petroleum Act 1923 with the Petroleum
Regulations (Land) 1966.	
S.O.M.	
Manual	The Queensland Surveyors Operations

INDEX

Item	Page
A Abandonments.....	10
Abbreviations.....	11
Access.....	12
Additions.....	13
Agent.....	13
Application.....	14
Applications for Watercourses..... See Determination of.....	25
..... Boundaries.....	
Angle Posts..... See Datum Post.....	21
Areas.....	15
Assessment of Plans.....	16
Availability..... See Entitlement.....	30
..... See Exclusions.....	30
..... See Priority.....	41
B Background Tenures.....	17
Boundary Marks.....	18
C Calculated Lines.....	18
Certificates.....	18
Claims.....	18
Compass Surveys.....	19
Compiled Plans..... See S.O.M. E2-136 (3.5).....	20
Connections..... See S.O.M. E2-26 (1.17).....	
Consolidation.....	20
Co-ordinates..... See Determination of.....	28
..... Boundaries.....	
Corner Information.....	21
Corner Posts..... See Datum Post.....	21
Crown Land..... See Land Sec. 5.....	
D Datum..... See S.O.M. E2-40 (1.24).....	
Datum Post.....	21
Departmental Survey Requirements..... See Survey.....	47
Determination of Boundaries.....	25
E Easement.....	29
Encroachment..... See Exclusions.....	30
Entitlement.....	30
Entry.....	30
Evidentiary Provisions..... See Sec. 413.....	
Exclusions.....	30
Exempted Land..... See Exclusions.....	30
Exploration Permit Surveys.....	32
F Fees.....	32
Field Notes.....	32
G GPS.....	33
Grant.....	33

Item	Page
H High Water Mark	34
Holder	See Sec. 5
I Identification	See Sec. 417(2)(c) & E2-45 (1.33)
Improved Land	34
Instrument of Lease	See Secs. 296 & 297
Instructions	34
J Jurisdiction	35
K	
L Land Definition	See Sec. 5
Licence	See M.D.L. Part 6 (Act) & Survey of Pipeline Licence PART C
Local Authority	See Sec. 5
M Maintenance of Datum Post	See Datum Post.....21
Marking	35
Meanings of Terms	See Sec. 5
MERLIN	36
Mining	36
Mineral Development Licence Surveys	73
Mineral Selection, Mineral Freehold	36
Mine Surveyor Certificate	37
Mining Districts	See Sec. 11 & 12
MTDB	See Merlin.....36
N Native Land Title	37
Numbering of Leases	38
O Objections	38
Occupied Land	See Sec. 5
Occupier	38
Order in Council	See Sec. 391 (Restrictions)
Owner	39
Ownership of Minerals	See Sec. 8
P Permanent Marks	39
Petroleum Permits, Leases, Licenses	39
Photogrammetric Surveys	39
Plan	40
Planning Provisions	41
Posts	41
Priority	41
R Registration	41
Removal of Posts	42
Report	42
Reserve	42
Restricted Areas	43
Restricted Land	43

Item	Page
Resumption	43
Right of Way	44
Road	44
S	
Search	45
Subject to Survey	45
Sub-lease	45
Surface Areas	45
Surrender	47
Survey	47
Survey Instructions	68
T	
Tenements	49
Titles	49
U	
Unlodged Survey Plans	49
V	
Variation	49
W	
Warden, Wardens Court	See Part 10 Div.2
Water Right	50
X	
Y	
Z	

PART A	General Requirements	Pg 10
PART B	Petroleum Well Location Surveys	Pg 58
PART C	Pipeline Licence Location Surveys	Pg 65
PART D	Survey Instructions - Example	Pg 68
PART E	Mineral Development Licence Surveys	Pg 73

INTRODUCTION

OBJECTIVES

The objectives of the Queensland Department of Minerals and Energy are to ensure that Queensland's Mineral and Energy resources are assessed, developed and utilised to the maximum extent practicable, consistent with sound economic and land use management.

By working through a system of permits, licences, leases and miscellaneous tenures issued under Acts of Parliament, the Department is responsible on behalf of the State Government for the supervision necessary to see that the stated objectives are met.

Survey Group of the Tenures Unit plays an integral role in attaining these objectives by providing services to other parts of the Department and by providing advice and services to private industry.

The Guidelines has therefore been produced to efficiently and effectively manage the Unit resources, to enable fast tracking of surveys and plan registration and to stimulate and improve public awareness and communication. It is also hoped that consequently the private survey industry will be better positioned to satisfy the mining industry's needs expeditiously.

PERFORMANCE

The text should clarify issues which are to be determined when effecting a survey for the Department. The ensuing survey plans should be prepared in accordance with the current Queensland Surveyors Operations Manual.

Surveys of exploration permits, mineral development licences, mining claims and mining leases are to be effected subject to the Mineral Resources Act, 1989 and the Regulations made thereunder. These surveys do not define the boundary limits of an interest in land but rather the limits of:

- (i) a right to search for or mine a specified mineral or minerals, or
- (ii) a right to carry out activities associated with exploration or mining

Where surveys are carried out under other Acts administered by the Department those Acts shall be addressed by their full title. A list of those titles and a brief reference to their content is shown at Pages 51-57. Surveys are not required for Prospecting Permits and seldom for Exploration Permits and Mineral Development Licences. Remarks generally apply therefore to Mining Claims and Mining Leases except where indicated.

References in the text are confined to surveys carried out by a surveyor licensed pursuant to the Surveyors Act 1977, in a way approved by the Minister, and by a surveyor approved pursuant to the Petroleum Regulations (Land) 1966.

PART A

GENERAL REQUIREMENTS

ABANDONMENT

An area of land being the whole or part of an application which is relinquished by the applicant at any time before grant is described as an abandonment.

The Act does not specify that a survey plan is required for a partial abandonment whereas a survey plan *is* required for the balance and a partial surrender of a surveyed lease. However, under Sec 407 the Minister may request a survey for part of a mining claim, exploration permit, mineral development licence or mining lease, or part of an application therefor.

Should a partial abandonment including a description by metes and bounds and/or sketch not be lodged, a survey plan prepared for the grant of the lease should show the abandonment by an action statement on the face of the plan.

Should part of an application be required for statutory or official purposes, a survey of the area to be abandoned should be effected, in which case the plan would be cited in an ensuing proclamation.

If the datum post was placed at a corner of a lease and that corner is coincident with a corner of a subsequent abandonment, then the post should not be relocated to a corner of the balance of the lease but should be maintained in its original position until the date of survey. The new application corners created by the abandonment should also be marked in the prescribed manner.

See Sec.108 for the abandonment of the whole of a mining claim. See also Variation p 49.

See Sec.159 for the abandonment of an application for an exploration permit.

See Sec.189 for the abandonment of an application for a mineral development licence.

See Sec. 307 for the abandonment of an application for the whole or part of a mining lease.

ABBREVIATIONS

The list shows past and present tenures most likely to be found in records and plans. Those marked with an asterisk are no longer issued by the Department whilst MHLs and MHPL's are now administered by the Lands Department. R of A (Right of Access), and R of W (Right of Way) are descriptive terms only.

The Second Schedule of the Act should be referred to for further details.

*A.M.C.	Alluvial Mining Claim
*A to P	Authority to Prospect
*B.A.	Business Area (D.O.L.)
*C.M.L.	Coal Mining Lease
*C.P.A.	Coal Prospecting Area
*D.A.	Departmental Area
*D.C.	Dredging Claim
*D.L.	Dredging Lease
*E.A.T.C.	Extended Alluvial Tin Claim
E.P.	Exploration Permit
*G.A.	Garden Area
*G.M.L.	Gold Mining Lease
*G.F.H.L.	Gold Field Homestead Lease
*M.A.	Machine Area
M.C.	Mining Claim
M.D.L.	Mineral Development Licence
*M.G.A.	Market Garden Area
*M.H.L.	Miners Homestead Lease (D.O.L.)
*M.H.P.L.	Miners Homestead Perpetual Lease
M.L.	Mining Lease
P.L.	Petroleum Lease
P.Lic	Pipeline Licence
P.A.	Prospecting Area
P.P.	Prospecting Permit
*R.A.	Residential Area (D.O.L.)
R.A.	Restricted Area
*R.M.C.	Restricted Mining Claim
*R.M.P.C.	Restricted Mining Purposes Claim
*R of A	Right of Access
R of W	Right of Way
*S.B.M.L.	Special Bauxite Mining Lease
*S.M.L.	Special Mining Lease
*S.P.M.P.L.	Special Perpetual Mining Purposes Lease (D.O.L.)
*S.G.C.	Special Gem Claim
S.A.	Surface Area
*T.A.	Tailings Area
*W.R.	Water Right

ACCESS

The relevant access provisions under the Act are:

	<u>Application Section</u>	<u>Description Section</u>
Prospecting Permit	20	
Mining Claim	61(1)(f) and (g) & 125	62
Mineral Development Licence	181(7), (8), 183(i) & 231	184
Mining Lease	245(d), (e), (f) & (j), & 317	246

An owner of land affected by an access requirement must be notified upon lodgement of the application. Subsequently, if the application is recommended for grant by the Warden, access will only be surveyed if directed as it is anticipated that the owner and applicant should settle upon a practical route and suitable compensation without the need for definition.

Where access to a mining lease is to be gained by way of an abutting road, shown on an office chart or topographical map, then an access description is not required. A description is required when the proposed access departs from the road before it crosses the lease boundary. It is imperative that the actual route to be used is clearly described in the application.

Further, an unsurveyed road or track, through a pastoral holding or occupation license which is shown as a dotted line on a map or plan published by the Department of Lands, may be sufficiently dedicated as a public road under Section 362 of the Land Act 1962. Roads may also be dedicated pursuant to Section 96 of the Land Act 1994.

An application for the variation of access should be lodged where the terminal point or the actual route of a surveyed access digresses from that granted.

Where a surveyor finds that the access if surveyed, deviates from the application route or where a terminal point does not fall on an acceptable access route or where access should be extended past the nominated terminal point to a more viable access, the surveyor should request further advice from the mining registrar.

There is no provision within the Act which precludes the granting of a mineral development licence over a reserve. However, note that Sec. 181(4)(b) does prevent access by the holder of a mineral development licence for authorised purposes without the consent of the owner of the reserve.

If access to a mining lease is surveyed the description on a survey plan should read "ML _____ and access".

See also Rights of Way at E4-44.

ADDITIONS

In general, land cannot be added to a mining lease. However, provision exists where land may be added to an ML or MLA by variations in certain franchise agreements. See Sec.295(1)(b) which also provides for exchange of areas on the common boundary of contiguous leases.

But certain provisions for addition apply upon consolidation. See Consolidation at p.20.

However additional area could be acquired by:

- (i) A new application over an adjoining area
- (ii) A surrender of whole or part of a mining lease and a fresh application lodged for that area and an additional adjoining area.
- (iii) By the addition to an exploration permit upon the termination of a granted mining claim or lease or the rejection or abandonment of an application for a mining claim, mineral development licence or mining lease. See Secs. 132 and 189.

Additional *surface areas* to leases may be applied for pursuant to Sec. 275 of the Act, but only over land where a lease already exists.

No provision exists whereby an addition to a surface area may be made to a mining claim. A mining claim should include the whole of the surface, Sec.48(2).

AGENT

There is provision in the Act for a person authorised in writing to lodge an application on the behalf of the applicant. But Sec 408 expressly prohibits a surveyor from having an interest in a mining claim, exploration permit, mineral development licence, or mining lease or application therefore which he surveys. Sec. 53 of the Surveyors Act also forbids a surveyor from having an interest directly or indirectly in a mining tenement which he has surveyed.

Many boundary anomalies could be eliminated if a surveyor were to manage an *application for an M.L. or MDL* but the survey prohibitions above should be noted.

APPLICATION

The Act outlines the first step in obtaining title to the rights to explore or mine land. The grant of a claim, licence, permit or lease subsequent to an application does not create an estate or interest in the land subject to the application (Sec. 10).

The construction of the application should consider:

Subject Matter

Definition of Minerals	Sec. 5
Ownership of Minerals	Sec. 8
Exclusive Right of Crown to Grant Minerals	Sec. 9

Identification of Land

Land	Sec. 5
Owner of Land	Sec. 5
Occupied Land	Sec. 5
Reserve	Sec. 5
Road	Sec. 5
Contaminated Land	Sec. 6

Availability of Land

Priority	p.41
Exclusions	p.30
Subject to Survey	p.45

Title Requirement

Prospecting	Part 3
Exploration	Part 5
Mining	Parts 4 & 7
Associated Purpose	Secs. 232, 234, & Schedule Sec. 6
Development	Part 6

Qualification of Applicant

Eligibility	Secs. 5, 7, 48, 180, 233.
Acceptability	Secs. 24, 137(1)(b), 137(4).

Application Requirements

Details Required	Secs. 21, 61, 133, 183, 245.
------------------	------------------------------

Application Process for Mining Lease

Selection of Land	
Obtain Prospecting Permit (Access purposes), Exploration Permit or Mineral Development Licence	
Marking Out of Land	
Application to Mining Registrar	
Certificate of Application Issued	
Mining Register may reject application	
Abandonment of Application in whole or part any time until Grant	
Inform owners of land of Issue of Certificate	

Conference between applicant and landowner may be convened
 Date set for hearing if required
 Minister may reject application or require an E.I.S. before applications close
 Warden's recommendation to Minister after hearing
 Lease conditions offered to applicant
 Acceptance of Conditions and payment of security
 Compensation finalised
 Survey at Ministers discretion
 Appraisal and Registration of Survey Plan
 Governor in Council grants lease
 Lessee advised of grant
 Mining may commence after acceptance of Plan of Operations.

Survey Interest in Application

The application indicates the description of the lease and or surface area. The Certificate of Application signed by the applicant is deemed to contain the correct particulars including description and marking details which may or may not conform with the particulars set forth in the application. Sec 252(4).

Rejection by the mining registrar or Minister should be verified. Secs. 266 and 267, 269(5).

The description and area in the certificate could be amended subsequent to the Warden's hearing. Sec. 269.

A lease area requiring survey could also have been reduced by the lodgement of a partial surrender, or a partial abandonment in the case of an application. Departmental Instructions to surveyors stress the necessity of verifying application details.

AREAS

Permits, Claims, Licences, Leases:

Excess areas of claims, see Sec. 53(4) and p.14 and Determination of Boundaries p.25

Limit of area see Secs. 14,15, 53, 55, 127, 186 and 245(1)(i).

Restriction on lease areas see Sec. 239 and 391.

Restriction on Grants (including areas) see Sec. 391.

See Entitlements p.30

See Exclusions p.30

Administrative areas:

See also areas which may be defined in the "Mining (Fossicking) Act", and references to additional Acts at p.51-57.

Areas on plan:

For the treatment of areas on survey plans generally see S.O.M. E2-18 (1.8).

For the treatment of specific areas for the preparation of Minerals and Energy survey plans see also

Right of Way,	S.O.M. E4-44
Road Area,	S.O.M. E4-44
Surface Area,	S.O.M. E4-45
Vinculum,	S.O.M. E2-145 (3.12)

ASSESSMENT OF PLANS

A survey plan prepared for the Department should satisfy the following requirements:

- Describe the subject land unambiguously on an approved Department of Minerals and Energy plan form.
- Be suitable for annexure to a lease document.
- Provide the lessee and others with evidence of the physical marking of the boundaries.
- See also S.O.M. E2-3.

When assessing whether the survey plan is suitable for the Department's needs the following factors are to be considered:

(Factors marked with an * may not concern the Surveyor)

- a) The presentation on the approved plan form is:
 - consistent with the S.O.M.
 - The survey reinstatement and information is acceptable.
 - The surveyors certificate has been correctly attested.
 - Supplementary attachments to the survey report have been lodged.
- b) Applicant's metes and bounds description including abutments.
 - Applicant's sketch.
 - If Applicant's description stated as being identical to a previous lease.
 - Minerals or purpose applied for.
 - Surface Area required.
 - Areas of MLAs or MLs covering background tenures.
 - Application on occupied or unoccupied land.
 - Application amendments.
 - Application abandonments or resumption of part thereof.
 - Application variations subsequent to Wardens hearing.
 - Date of receipt of Application in mining registrar's office and priority of other claims, exploration permits and leases subject to order of lodgement dates and times.
 - Roads and reserves to be included or excluded from the lease or surface area.
 - Unavailable areas to be excluded.
 - Access.
 - Shape and Area variations approved.
 - Tidal and watercourse boundaries.
 - Position of Datum Post and application posts with respect to the land applied for.

* Compensation Agreements over affected background tenures to be lodged.

Recommendations of Warden.

Minister may recommend to Governor grant of part only

c) Subsequent to grant, the following information may also be relevant:

* Minister's recommendation for Grant.

* Executive minute of grant.

* An Instrument of Lease issued subject to survey.

A surrender or resumption of part of the surface area or lease.

Addition to the surface area.

BACKGROUND TENURES

The presentation of background tenure is described in the S.O.M. E2-135 (3.2).

The general requirement is that all existing cadastral background information should be shown. Care should be taken where the background tenure has a depth restriction which may not be defined by numerical description. A description term such as "to the depth of the coal seam" is sometimes used.

When the background tenure has separate strata titles in depth, the description of the surface strata should be shown where the mining lease has surface rights. It may be necessary to show a table listing descriptions and plan numbers of the sub-surface tenures.

The sub-surface tenure may also be shown on the face of the plan where the mining lease has no surface areas.

Variations to the conditions to surface areas or leases may occur where certain actions take place on background tenures subsequent to the survey of the lease.

- See a) Easements p.29
- b) Resumption p.43
- c) Roads p.44
- d) Reserve p.42

In the cases of b, c and d, a survey plan should also be lodged in the Department of Minerals and Energy showing the effect on the lease and/or surface area.

Since easements cannot be granted over a mining lease a survey plan showing that easement over a mining lease should not be lodged. However, since an easement bestows some physical benefit on the grantee it is assumed that the grantee will also negotiate with the mining lessee.

Changes to the background tenure subsequent to the grant should not affect the circumstances applying at the date of application. A survey plan however will show the background tenure existing at the date of survey.

BOUNDARY MARKS

Boundary marks when mentioned in the Act refer to the marks placed by the applicant on a mining claim or lease. These marks are further described under:

Datum Post p.21
Marking p.35

Boundary marks in the survey context are referred to in Clause 13 of the Instructions. But the Act points out that boundary marks shall be maintained until the date of survey when the survey marks at least must be maintained. See Secs. 81(1)(m), 90, 274 and 276(1)(k).

CALCULATED LINES

Lines on a survey of a mining claim, mining lease, mineral development licence or exploration permit shown calculated or unsurveyed on a survey plan may be lines adopted from the application or grant. The plan is not suitable for issue of a lease and may be subject to amendment, since availability will depend upon a field survey of the lease / application boundaries. Such lines should not be confused with calculated lines derived from survey information as described in the S.O.M. E2-21 (1.11).

The certificate of compilation should clarify the origin of information.

CERTIFICATES

Certificates in relation to mining but not relevant to surveys are not discussed. Relevant Certificates are signed by the surveyor in accordance with the Mineral Resources Act 1989, Surveyors Act 1977 and the Petroleum Act 1923 and the Petroleum Regulations, (Land) 1966.

Certificate of Application see Application, p.11

Certificate for Petroleum Well location surveys. See S.O.M. E2-136 (3.2.2).

Certificate for Compiled Plan for unsurveyed Mining Lease See S.O.M. E2-137 (3.5.5).

Certificate for Mine Surveyor. See p.37

CLAIMS

Surveys of claims may follow:

Request by applicant or holder

Request by the Minister under Sec. 407.

Investigation of illegal mining; or most likely:

Surveys of adjoining mining claims, mining leases, mineral development licences or exploration permits to determine priority.

The rationale for the survey of mining leases may be followed in the survey of mining claims but with the following qualifications and subject always to Part 4 of the Mineral Resources Act.

Prescribed Areas or less

Should the area not conform in shape (Sec.53), the direction of the applicant or claim holder and/or mining registrar should be sought. Non-conformity of shape may be acceptable if availability is determined by adjoining areas.

The description of the survey plan should read "Mining Claim". However where approval to a non conforming shape has not been obtained the claim should be surveyed claim post to claim post, reference marks placed and the description on the plan should read "Area occupied as Mining Claim".

Excess Areas

Claims should be surveyed claim post to claim post, reference marks placed adjacent to the posts and referenced to the posts.

Where an area (found upon survey) exceeds the prescribed area a survey sketch should be prepared describing the area as "Survey of Area Occupied as Mining Claim ..." and a copy forwarded to the District mining registrar whence the status of the mining claim may be determined under Sec. 53(4). A variation to the mining claim may be endorsed under Sec. 82(1)(3).

If the local registrar does not have the services of a regional surveyor a copy of the survey sketch should also be forwarded to the Chief Surveyor.

When the excess area has been determined and the applicant has moved his posts (excluding the datum post) to the approved positions, a survey plan, which must show the original reference marks, should be lodged.

Excess areas disclosed in adjoining claims during the survey of applications or grants should also be referred to the mining registrar. However a plan prepared for applications or grants, may include in the survey and plan description an adjoining mining claim where an excess area has been resolved by the registrar.

Mining claims restricted to an area of 1 hectare or less, may nevertheless be restricted to a smaller area which is gazetted under Section 391. See also Sec. 53(3).

COMPASS SURVEYS

Compass surveys are not normally acceptable for the definition of a mining boundary at the survey plan stage. However the Act does permit compass bearings to be used at the application stage. Secs. 62, 184 and 246.

The surveyor should verify the meridian cited at the application stage and show a comparison to the meridian of the survey plan by recording a compass reading if necessary.

COMPILED PLANS

The S.O.M. E2-136 (3.5) discusses presentation of compiled plans. But the surveyor should note, that to minimise costs, compilation may be allowed in certain cases. However the surveyor should be satisfied that the posting is adequate and occupation reasonably defines the boundaries. The definition must be sufficiently clear so that the M.L. boundaries are distinguishable from other boundaries.

The datum post must be shown on the plan.

CONSOLIDATION

Two or more contiguous leases may be cancelled and an amalgamated lease granted by the Governor in Council following the lodgement of an application by the lessee, Sec 299. Under the Act this is termed consolidation.

If there is insufficient survey information to compile the dimensions of the new boundaries of the consolidated lease then a survey will be required.

In any case where sufficient information exists the applicant will be required to lodge a compiled plan for registration embracing the new lease.

The surveyor should be aware that gaps may occur between granted leases and which may have not been obvious until the survey is carried out. Fresh applications are required over the gaps and consolidation cannot take place until the applications are granted. Note that Secs. 48, 179 and 232 require an applicant to hold prior titles.

Two survey plans will be required. The first plan will disclose the position of all the leases including the gaps. The second plan will show the exterior boundary of the consolidated lease.

However Sec.299(6) enables gaps to be included in a consolidated title by the Governor-in-Council. Contact the Chief Surveyor before including any land that is not in the M.L. application.

Notwithstanding the above provision the surveyor shall lodge the location information with the Chief Surveyor. The survey plan *will only be drawn* when any gaps are included pursuant to the above provision. Otherwise two plans will be required as described above.

CORNER INFORMATION

The Act requires all mining lease and mining claim application corners to be posted and marked or obtain the mining registrar's acceptance of alternative procedures. See Sec. 57, 58, 241 and 242.

See also: Datum Post p.21
Marking p.35

For survey information and presentation see S.O.M. E2-29 (1.21) and Departmental Instructions.

DATUM POST

One of the application corner posts is selected as the Datum Post to mark a claim or a lease and from which a description and survey must commence. Sec. 57(4) and 241(4).

These sections also prescribe:

- The type and size of posts to be used.
- The marking of the posts.
- Alternative marking.
- Alternative procedures should posting be impossible.
(Secs. 58 and 242 require consent to alternative marking.)

The datum post of the claim or lease shall be appropriately numbered within 7 days of the issue of the Certificate of Application. Secs. 64(6) and 252(7).

The remainder of the application posts shall be appropriately numbered within 7 days of the grant of the claim or lease unless the claim or lease has been surveyed. Secs. 90 and 274.

The application posts shall be maintained until survey. Secs. 90 and 274.

After survey the survey posts and pegs at least shall be maintained. Secs. 81(1)(m) and 276(1)(k).

Moving of a datum post by an *applicant only* is allowed under Regulations 16 and 40. The datum post of a granted lease cannot be moved. Field Notes/survey report should show both the old and new positions of a datum post. Since a survey shall commence at the datum post (Secs. 57 and 241) and the datum post maintained until the completion of the survey (Secs. 90 and 274), actions of abandonments or surrenders necessarily rely on the determination of the original application.

The Mining Acts of 1898 and 1968 contained similar provisions in that only the *applicant* and not the lessee could move the datum post. Likewise leases granted pursuant to those Acts cannot be relocated.

Unavailability resulting from encroachment and subsequently revealed by a survey would not permit the relocation of the datum post from an encroaching position. However, removal of applications posts would be possible after completion of the survey, especially since survey marks are statutorily protected by Secs. 81(1)(m), 276(1)(k), and Regulation 65 of the Surveyors Act.

Depending upon the location of the lease it may be prudent not to disturb the application posts after survey to substantiate identification of the lease. In any case the survey is not complete until the plan is drawn. Posts should not be removed until the plan has been lodged and registered. Datum Post location surveys are effected to cadastral standards pursuant to the provisions of the Surveyors Regulations, to assist the following purposes:

- Location updates
- Resolution of location disputes
- Identification of survey problem areas
- Reference point locations for mining claim and lease application connections
- Survey control

Note that Departmental policy requires that the preparation of plan and field records for Datum Post location surveys comply with the specifications for a mining lease survey.

The S.O.M. at E2-136 describes the procedure when a compiled plan of an unsurveyed mining lease is drawn and how reference shall be made to the datum post.

Details of datum posts recorded in the Field Notes should show:

- Location
- Description of post
- Markings
- Remarks on unusual aspects

The prescribed methods of posting for a mining lease application follow in chronological order with new applications subject to the Mineral Resources Act 1989.

**Marking For a Mining Lease Application
Prior to 31 August 1990**

Date of Application	Reg or Sec	Datum Post		Application Required	Posts
		Location	Marking		
Up to 31/12/71	Reg 91	At corner	Initials	No	Marking
From 1/1/72	Reg 32	1 to 10 yds of corner	Initials	Yes	None
From 28/10/76			Initials, Surname		
From 20/1/77		1 to 10 m of corner	Date of Marking		
From 22/7/79	Sec21(6)(c & Reg 19(1))	At corner	Initials, Surname	Yes	Initials, Surname, Date of Marking
From 1/8/82	Sec21 (2Ac)		Date of Marking & ML no.		Yes, except on Crown Land without Surface Area

Introduction of Mineral Resources Act 1989

Date of Application	Reg or Sec	Datum Post		Application Required	Posts
		Location	Marking		
From 1/9/90	Sec 57 Sec 241	At corner	Initials, Surname	Yes	Initials, Surname or Company Name
Note: Includes Claims	Sec 240 S64(6)(b) S252(7)(b)) Sec 90 Sec 274		Company Name Initials Date of Marking		Initials Date of Marking
			Claim no. ML no.		Claim no ML no.

**This page has been
intentionally left blank.**

DETERMINATION OF BOUNDARIES

The fixation of a cadastral boundary that is not suitably monumented is governed by the intention of the original surveyor, supported by physical, behavioural or documentary evidence.

Intention is also of the essence in the positioning of boundaries for the grant of a mining lease. However, since the originating party at application stage need not be a licensed surveyor, the setting out of those boundaries could be more uncertain.

Therefore in the positional assessment of a mining lease boundary supportive evidence to verify intention should include the following considerations:

Calls

The list is not prioritised nor exhaustive.

Abuttals -Where possible abuttals should be included in the description at the application stage in support of, but not in substitution of, stated bearings and distances.

Adjudication i.e. A Warden's or Supreme Court ruling unless the registrar has approved an alternative method of description (Sec. 246)

Applicant's description

Applicant's intention

Applicant's posting

Applicant's sketch

Areas

Availability (Subject to Exclusions and Priority)

Exclusions p 30

Metes

Statutory Requirements

Monumented lines and corners

Natural features - though the Act requires accurately measured bearings and distances to be used in a description, provision exists under Section 62, 184 and 246 for alternative methods to be used.

Priority p.41

Physical mining evidence.

Marking

The Survey Instructions require the surveyor to have the applicant point out the datum post and application posts. Adjoining lessees and applicants are required to do likewise if encroachments are likely to exist and therefore entitlements jeopardised. The survey report should be clear on the presentation of this evidence in support of information shown on a survey plan.

Applicants must maintain marking. Secs. 81(1)(m), 90, 274, 276(1)(k). Surveyors should not proceed unless these marks exist except where consent not to mark has been granted under Secs. 58 and 242. Details concerning non-maintenance of marks should be forwarded to the relevant mining registrar for resolution and also to the Chief Surveyor.

Marking of Watercourses

With applications following natural features such as creeks and watercourses, providing consent under Secs. 58 or 242 was obtained, the following procedure for marking out an application for a mining lease shall be adopted:

- The terminal limits of the application shall be marked;
- The terminal limits on branch creeks flowing into the creek the subject of the application shall be marked;
- The terminal limits shall be marked by two posts, one on either side of the creek;
- A bearing and distance shall be shown between each pair of terminal posts;
- Bearings and distances shall be shown to a reference tree or mark from at least one of each pair of terminal posts;
- The corners from which reference marks are placed may be numbered on the sketch and the reference marks tabulated at the completion of the description;
- The preferred alternative is to show the information on the sketch as illustrated in the diagram on p.24;
- Reference marks should be easily identifiable and/or well marked objects or features but may also be previously marked and identifiable corners;
- The diagram on p.24 indicates markings and their possible descriptions.

The application description should follow either of the following examples:

- (a) The land, the subject of the application, may be included within lines described by bearings and distances, as illustrated by the diagram on p.24.

or

- (b) As per "a" but with an added qualification expressly stated eg. "Commencing at the datum post and proceeding 880 for 92m, ----- 780 for 60m, to the point of commencement. The described lines lie 10 metres more or less and to the west of the right bank of Hopeful Ck, 6 metres more or less and to the west of the right bank of Branch Ck, 8 metres more or less and to the east of the left bank of Branch Ck and 12 metres more or less and to the east of Hopeful Ck."

If the consent of the mining registrar is not obtained under the provisions of Secs. 58 or 242, then the applicant must mark all corners, but the sample descriptions in either "a" or "b" would still be used.

The above processes are not to be adopted for the survey of a mining lease. Any proposal to survey only part of the boundaries of a mining lease should be put to the Chief Surveyor.

Cadastral boundaries

An application may rely on or refer to or abut on previously fixed cadastral boundaries for the fixation of the lease boundaries. Therefore, the surveyor could then rely on a normal "fixed-boundary" approach in the first instance with the subsequent positioning of the lease in the second instance.

However note the status of the datum post in Secs. 57(4),241(4).

However where a cadastral boundary has not previously been determined, eg. a Pastoral Holding boundary, the surveyor must verify its determination with the Department of Lands.

The intersection of a cadastral boundary with a M.L. should be pegged and the allocated areas of the surface area/lease shown on the plan. There can be no compromise if the cadastral boundary limits the extent of the mining lease since an encroachment over the cadastral boundary could involve compensation with further background tenures holders. Compensation must be settled before the grant of a lease.

A mining lease could extend beyond a cadastral boundary but compensation may not be payable if the surface area were confined by the cadastral boundary. But note that in the latter case if longwall mining were involved compensation could still be claimed. See Sec.280.

Orientation

Reference should be made in the application to the origin of the meridian. Frequently none is stated. Four alternatives exist: magnetic, County Arbitrary Meridian (C.A.M.), Australian Map Grid (A.M.G.), and True. An attempt should be made to define the original meridian at the application stage and record a comparison at the survey stage.

Fixing orientation by meridian would only be done in very rare cases. Where the orientation of a lease is not fixed by meridian, or the direction of adjoining boundaries, or other evidence, policy requires that the direction be fixed which adopts the datum post and one of the other application posts to best accommodate the applicant's intention. In many cases the datum post and the application post on the first line of the description are adopted excepting where the first line is so short that a distorted orientation would result.

Dimensions

Every case must be treated on its own merits but the surveyed dimensions of a granted lease should not exceed the dimensions in the certificate of application. However the dimensions and area should usually be less than those granted if a survey reveals unavailable land. The area may be limited by Order in Council, such as in the Anakie Restricted Area. If a survey reveals a reduction in area to that shown on the application and it is not due to calculation differences, an abandonment or surrender should be lodged over the area excluded with the survey report. The exclusion should be shown by action statement on the plan.

Since dimensions rely on qualitative measurement, all evidence should be considered before assuming their acceptance.

Co-ordinates

The geographical or geodetic co-ordinates are frequently quoted as the origin position of the datum post. On some larger leases, mineral development licences and especially exploration permits, boundaries are quoted as one minute segments of parallels of latitude and longitude. The determination of the boundaries devolves into a survey task only, providing the datum post was correctly placed for the lease application. The standard of survey required is nominated in the instructions. The monumentation of the boundaries eliminates future interpretation.

When co-ordinates are not used at the application stage, their substitution for original boundary descriptions at the survey stage is only acceptable if the co-ordinated values are determined for previously monumented survey corners of the application, or coincide with the original described corners, including the datum post. See S.O.M. E2-27 (1.20).

Previous Descriptions

Frequently an application quotes the present description as coincident with the description of a dead mining lease or application. Departmental records may reveal valuable evidence as to the location of the new application despite contradictory evidence in the present description. If the applicant intends the new application to cover a prior lease or claim now dead the new description should include "covering previous ML.... or MC....", and care should be taken with marking out to see that the application truly covers the original tenement.

Statutory Considerations

Should surveys be effected relevant to Acts administered by the Department and which are listed at pages 51-57, the surveyor should refer to the particular Act where boundaries may be prescribed; eg, Commonwealth Aluminium Corporation Pty Limited Agreement Act (Sec 60).

The Mineral Resources Act also defines areas where leases and or surface areas may not be granted without the consent of the owners, which, in effect, could mean that lease and or surface area boundaries could be determined by prescribed conditions. See Secs. 14, 51, 129(1), 129(3), 181(6), 181(8) and 238.

Interpretation

Ultimately the position of a mining boundary is a legal matter. However provided the surveyor amasses the suggested evidence his interpretation of that evidence to prove the original intention could be the best available, particularly if supported by a letter or signed statement of acceptance of the boundaries by the applicant.

EASEMENT

No provision exists under the Mineral Resources Act to register an easement over a mining claim or lease.

An existing easement should be shown as background tenure on a survey plan for a mining application. Whether the application includes or excludes the easement from the surface area or lease should be clearly shown. If the easement is included special conditions may apply to the mining lease, depending upon the purpose of the easement. Generally, a variation to conditions may occur upon renewal of the mining lease or mining claim, if an easement has been created since the grant of the lease.

Should an easement be created after the grant of the mining lease the lessee should reach agreement with the dominant tenement or grantee regarding easement conditions imposed which may affect the mining lease. The dominant tenement may also require a formal deed of agreement with the lessee of the mining lease to further protect the former's interests in the easement.

Easements created for access purposes on background tenures should not be confused with access required to mining leases under the Act, the treatment of which for survey purposes is shown in the S.O.M. E2-143, 3.16.

See also Access p.12.

Provisions under Section 31 of the Petroleum Act ensure protection for the lessee upon construction of improvements including pipelines.

A lessee may enter into easement agreements with the holder of the background tenure but there is no process for endorsement of these easements on the petroleum lease. Under Section 44 a provision to endorse easements on a Petroleum Lease is reserved to the Crown only.

Pipeline licences usually contain provisions to provide evidence of registered easements. See Part C.

A pipeline license extends between nominated terminal points and no provision for severance is made whereas easements may be discontinued, for example, at road crossings.

Where land is common to both a lease and license the easement provisions of the license will prevail.

A lesser agreement than an easement may be made with the holder of the background tenure but a survey plan would be required for an easement. However this plan need not be lodged in this Department. But if a survey plan is prepared for a petroleum lease the surveyed easement should be shown as background tenure.

ENTITLEMENT

The Act outlines the rights of the holder and the rights of use and associated purposes over the area of the land the subject of the grant.

See	Prospecting Permits	Sec.18
	Mining Claims	Sec.50
	Exploration Permits	Sec.129
	Mineral Development Licences	Sec.181
	Mining Leases	Sec.235

ENTRY

A surveyor may obtain right of entry under Sec. 67 of the Surveyors Act to carry out survey work.

However, entry may also be attained under provisions in the following sections:

Prospecting Permits	Sec. 18,19 & 20
Exploration Permits	Sec. 129
Mining Claims	Sec. 50(1)(b)(i)
Mineral Development Licence	Sec 181(4)(b)
Mining Leases	Sec. 235(1)(a)
Minister may require Survey	Sec. 407

Entry could also be effected subject to the Minister's authorisation under Sec.342(1)(e)(i).

EXCLUSIONS

Availability of land defines the balance area remaining after the proposed application area has been reduced by prior entitlements. The balance may still be subject to legal appeal and qualification by grant.

In general a reduction of the land area in a proposed application may be called an exclusion which would include the following but when marked with an * may include a relief from the exclusion.

Note: Availability of a grant may also be determined pursuant to prior legislation under which that grant was made.

No	Exclusion	Section	Grant Affected
1	Abandonment(Part)	307	ML
2 *	Entitlement (Reserves, Buildings)	19	PP
	Entitlement (Reserves, Buildings)	51(2), 54	MC
	Entitlement (Reserves, Buildings)	129	EP
	Entitlement (Reserves, Buildings)	181	MDL
	Entitlement (Reserves, Buildings)	238	ML
3*	Excess Area	53(4)	MC
	Excess Area	127	EP
4*	Exclusion of Prior MC, ML, MDL	16	PP
	Exclusion of Prior MC, ML, MDL	51	MC
	Exclusion of Prior MC, ML, MDL	132	EP
	Exclusion of Prior MC, ML	182	MDL
5*	Exempt Land	135	EP
	Exempt Land	226	MDL
	Exempt Land (except Coal or Specified Mineral)	239	ML
	Franchise Areas		
7	Protected Areas	3	ALL
8*	Priority: Claims	63	MC
	Exploration Permits	131	EP
	Mineral Development	185	MDL
	Licence		
	Leases	251	ML
	Competing Applications	390	MC,EP,ML
9	Restriction on Grants	391	ALL
10	Restriction on grant of ML where no surface area or adjoining ML	273	ALL
11*	Railways	Regs. 15 39	MC, ML

***Relief from Exclusions**

2. Consent of owners may be obtained
3. Mining registrar and holder, or Wardens Court may decide where excess lies in mining claim.
Minister may approve excess (to EPs)
5. Moratorium period of 2 months upon expiration of an exploration permit.
5. Minister may determine availability of land for a mineral development licence.
Exclusion does not include applications for coal
5. Moratorium period of 2 months on limited areas for a mining lease application upon expiration of an exploration permit.
8. Exploration may be granted for different minerals over the same sub-block
11. Mining near railway lines is restricted. An election could be made to exclude the restricted area from the application.

Encroachment

Encroachments upon land not properly excluded may be eliminated by enforcement of the provisions of the Act.

Encroachments upon unavailable land for other reasons should be resolved by the known facts. In whichever case, the extent of the encroachment should be resolved by survey.

EXPLORATION PERMIT SURVEYS

Surveys are not normally required but when commissioned for these purposes should satisfy the following:

Settlement of disputes with adjoining claim, lease, licence and permit holders by defining the common boundaries.

Marking of boundaries to define the equivalent or coincidental ensuing mining lease or mineral development licence boundaries.

Marking of boundaries to comply with a statutory requirement.

See S.O.M. PART E2-137 (3.7) and exploration permit or mineral development licence grant and file for survey details which may be enumerated.

FEEES

Survey fees are not payable upon lodgement of any application for a mining tenure.

Survey fees will be refunded on existing applications not determined at the commencement of the Act. Survey fees associated with unsurveyed granted mining leases may be refunded upon approval of a plan of survey.

Plan lodgement fee as prescribed shall be payable upon lodgement. Reg.74.

FIELD NOTES

Field Notes may be required with the cadastral survey plan. Field Notes for surveys effected under Departmental contract instructions for other than cadastral purposes may also be required.

It is expected that information shown on the plan will be available in the Field Notes.

The following guidelines may be used to prepare Field Notes for the Department:

- a) Covers used to enclose Field Notes should be in a standard Department of Minerals and Energy format.

- b) Field Notes may be recorded in any recognised style providing all necessary information is clearly unambiguously described. Photocopies of plans are not acceptable as Field Notes.
- c) Title page of the Field Notes could show, subject to (b):
Surveyors name or company;
Commencement and Completion date;
Description of Datum;
Meridian reference;
Origin of AMG Co-ordinates.
- d) Information
Generally the information required pursuant to Sec. 33 of the Surveyors Regulation 1992 should include:
Details as requested in the Departmental Survey Instructions
Calculations
Meridian Observations
Report
Signed Certificate in accordance with Form 12 of the Surveyors Regulations
- e) Certified copies of field notes may be lodged but the original notes made in the field must be reserved and produced if requested.

GPS

Control by GPS should comply with the standards and specifications referred to in the current draft of the "Inter-Governmental Advisory Committee on Surveying and Mapping, Standards and Specifications for Control Surveys".

However apart from the above standards *note* that the Department has its own guidelines which must be observed for *all* surveys carried out by the Department.

The guidelines stress that *unclosed survey methods are not acceptable*.

GRANT

An unsurveyed mining lease and issue of the instrument of lease shall not be avoided due to deficiencies in the description. (See Sec. 289).

Therefore a survey need not necessarily be governed by the metes and bounds of the lease when disclosed evidence proves them to be inappropriate, in which case provision exists under Sec.295 to vary the lease. See also Dimensions at p.28.

Different legislative requirements govern progress for the various grants. But for the surveyor's guidance the general steps towards the grant of a mining lease follow the application progress described in "Application" at p.14.

HIGH WATER MARK

No specific provision exists in the Act to describe the boundaries of a mining claim or lease by natural features. (The Act actually prescribes that accurate bearings and distances be used in the description).

When a boundary in an application is described by reference to the High Water Mark the survey of that boundary for the grant of a mining claim or lease shall consist of a series of right lines which may be coincident with or abut the High Water Mark. The descriptive boundary "High Water Mark" adjacent to the lease boundary, should also be shown on the survey plan. See S.O.M.E2-45 (1.32).

The application description could be in the form:

Thence following HWM, 100m on a bearing of 90 degrees, for 200m on a bearing of 135 degrees, 250m on a bearing of 190 degrees, 500m on a bearing of 245 degrees, and thence (departing from HWM) for 1000m on a bearing of 270 degrees along the boundary fence between Lots 1 and 2 on RP 123456, thence to the point of commencement.

When a tidal reference plane other than High Water Mark is adopted then that reference plane should be suitably described.

See also natural features under "calls" at p.25.

If the contentious term *High Water Mark* only is used for a boundary description the surveyor should demonstrate how the H.W.M. was determined since it may not coincide with a cadastral determination and give rise to land not being covered by compensation agreements.

IMPROVED LAND

No definition exists under the Act to describe improved land. However certain improvements on land constitute an exclusion (p.30). These exclusions from an application, unless the consent of an owner is obtained, are described at Sections 19, 51(2), 129(1)(a), 129(3), 181(4)(b), 181(8), and 238.

INSTRUCTIONS

Instructions for the cadastral surveys of mining applications or grants could issue in the following ways:

1. Instructions to a Department of Minerals and Energy Surveyor.
2. Instructions to a Licensed Surveyor in private practice to effect surveys for the Department under contract.
3. Instructions from an applicant or holder to a Licensed Surveyor in private practice.

4. Instruction from an applicant or holder to a Licensed Surveyor in private practise following the Minister's direction under Sec. 407.
5. Instructions from a Warden made for any survey purpose to aid in the determination of proceedings before the Court. Sec 380.

For Surveys under (2) above Departmental Contract Requirements shall be issued.

For Surveys under (3) to (5) Departmental Instructions at PART D shall apply.

Special requirements affecting surveys in individual circumstances under (2) to (5) may be added to the Departmental Instructions or Contract Requirements. See also PART D.

JURISDICTION

Surveyor's Responsibilities

The surveyor is an expert witness who gathers and interprets the evidence to enable a survey plan to be drawn which represents the mining lease boundaries to be registered. The position of the boundaries is a matter of mining law. The procedures for managing disputations are defined generally in Part 10, Division 2, Sections 344 to 385 and more particularly Sections 363, 370, 376, 379 and 380.

MARKING

The term refers to the procedure for:

Placing posts or alternative marks at the corners of mining or mining lease applications, See Secs. 57, 241.

Marking or suitably engraving the datum post. See Secs 64(6) and 252(7).

Marking or suitably engraving the boundary posts within 7 days of claims the grant. See Secs 90 and 274.

Marking in the survey context refers to marks or pegs placed in accordance with the Surveyor's Act and Survey Instructions issued pursuant to the provisions of the Mineral Resources Act.

A surveyor may mark an application when authorised by an eligible person. That marking shall be in accordance with Sec. 240 and 241.

Following lodgement of the application and after the Wardens hearing a formal survey may be required.

Survey marking is referred to in the instructions in Page E4-68.

MERLIN

MERLIN -(Minerals and Energy Resource Location and Information Network -a data base).

Merlin supports the mining tenure administration. A network of computer linked district offices with Brisbane head office, supports the regional operation in Queensland.

The data base is a combination of attribute and graphical functions which will provide information on all mining tenures relevant to:

- Land availability, subject to confirmation by survey.
- Processing of applications, variations, transactions and dealings.
- General enquires.
- Individual charts will be eliminated but the graphics will provide a single map co-ordinated display with a cadastral and/or topographical background.

MINING

These guidelines outline matters involving boundaries and related surveys. Part 1 of the Act and particularly the terms in Sec.5 introduce this involvement.

Surveys related to physical mining are not commented upon. However, qualifications required for surveys related to physical mining are referred to at "Mine Surveyor's Certificate" p.37.

Surveys related to petroleum mining are commented on in Parts B and C.

MINERAL SELECTION

A Mineral Selection or Mineral Freehold is a Lands Department tenure issued under one of the following Acts:

The Crown Lands Alienation Act of 1860, Sec.22.

The Crown Lands Alienation Act of 1868, Sec.32.

The Mineral Lands Act of 1872, Sec.21.

Providing the Deed of Grant was issued, thus indicating that the conditions for freeholding were met, then a record of that freehold should be available in the Lands Department.

The deed of purchase would reserve specified mineral rights to the grantee. But note Sec.9 whereby the Crown has an exclusive right to grant mining leases etc, irrespective of the ownership of the minerals.

Grantees of Mineral Selections can:

- i) Sell surface rights and retain mineral rights

- ii) Sell mineral rights and retain surface rights
- iii) Sell both rights.

Note: They may sell the sub-surface land as well as the mineral rights.

The owner of a mineral selection had prior application rights over any other application within the prescribed period, which has now expired. See Second Schedule Clause 9.

The Crown's property in minerals is defined in Sec. 8.

MINE SURVEYOR'S CERTIFICATE

A person may apply for:

- a) A Mine Surveyor's Certificate which applies to all types or classes of mines.
- b) A Mine Surveyor's Certificate limited to Open Cut mines.

Further, the Board of Examiners, Queensland Department of Minerals and Energy may grant a Mine Surveyor's Certificate with such other limitations and conditions as it deems proper.

A licensed surveyor may satisfy the academic requirements of the Board.

In the list of Acts at pages 51-57 references to certificates are made in the relevant Acts.

A licensed surveyor does not require Departmental approval to carry out surveys in a metalliferous mine (Section 51 of the Mines Regulation Act 1964-1983) but would be subject to the control of a mine manager (Section 27 of the Mines Regulation Act 1964-1983).

The Board of Examiners, Department of Minerals and Energy should be contacted for detailed information required for certificates or additional requirements for other than metalliferous mine surveys. In the case of metalliferous mines it would be prudent to contact the local Inspectorate of Mines.

NATIVE LAND TITLE

When a surveyor lodges a survey plan of a lease application, an application for additional surface, or a renewal, then evidence of extinguishment of native title must be lodged. This evidence may have been collated previously by the applicant or lessee.

A survey of a granted lease (with the possible exception of a renewal) would be exempt from the above requirement.

The surveyor should verify with the mining registrar whether a search has been carried out. The registrar can clarify the procedure required. The Department of Lands may also clarify their procedure.

NUMBERING OF LEASES

A state wide numbering system eliminating duplicate numbers in different districts has been introduced for mining leases. When dealing with a mining lease, the new number should be referred to and may be qualified by the statement "Formerly ML _____" where necessary.

The State wide number allotted to a mining lease shall be used by the surveyor. See Marking p.35 and the Survey Instructions at PART D.

OBJECTIONS

Objections which may be lodged to the grant of an application:

Mining Claim	Sec. 71
Mining Lease	Sec. 260
Mining Registrar may convene conference with owner.	
Mining Claim	Sec. 65
Mining Lease	Sec. 254
Mining Registrar may reject claim at any time	
	Secs. 61(5) & 73
Minister or mining registrar may reject mining lease application	
	Sec. 250, 266 & 267
Wardens Court's determination of hearing of objections on claims	
	Sec. 78
Wardens' recommendation on hearing of mining lease application	
	Sec. 269
Minister's recommendation on grant of mining leases	
	Sec. 271

OCCUPIER

The following definition in the Local Government Act may assist clarification of the term in the Mineral Resources Act.

"The person in actual occupation of any land, or if there is no person in actual occupation the person entitled to possession thereof: in the case of a gold field or mineral field the term includes any person in actual occupation of any land comprised within any gold mining lease or mineral lease or miners' homestead lease under any form of tenancy from or by the consent or with the leave and license of the lessee."

Note definition of occupied land in Sec.5.

OWNER

See Sec 5.

The definition in the Local Government Act may also be relevant when assessing rateable land.

"The person other than Her Majesty who for the time being is entitled to receive the rent of any land or who if the same were let to a tenant at a rack rent, would be entitled to receive the rent thereof: The term includes a lessee from the Crown...

the holder of a mining tenement under or within the meaning of the Mineral Resources Act.

PERMANENT MARKS

See S.O.M. E2-27 (1.20.2).

See Departmental Survey Instructions at PART D.

Records of Permanent Marks and Geodetic Information should be searched in the Survey Records Sub-program, Division of Information, Department of Lands.

PETROLEUM PERMITS, LEASES AND LICENSES

It is unlikely that surveys will be required for a permit or lease, the description of which follows the sub-block format. See exploration permit survey at p.32. Provision does exist however, under Sections 14(3) and 28(4) and 29A(5) of the Petroleum Act 1923 to request a survey of a permit and lease respectively, and Sec 37(iii) for the survey of surface areas.

Survey plans for permits and leases shall be presented as required in the S.O.M. on Departmental plan forms.

There are no provisions that require a survey of a "permission" to build an oil refinery. (A "permission" is an actual grant by the Governor-in-Council).

Survey requirements for a pipeline licence under the Petroleum Act are described in Part C.

PHOTOGRAMMETRIC SURVEYS

Mining lease boundaries are not usually defined by this survey method. However in remote localities where connections to a cadastral or geodetic point are not possible it may be permissible to connect a lease boundary to a clearly identifiable air photo point. In this case the additional survey directions would be explicit, but it is likely that the use of G.P.S. would be the preferred option.

PLAN

All surveys should be drawn on approved plan forms only available from, and at a cost set by, the Chief Executive, Department of Minerals and Energy.

Plan forms are available in two sizes, A2 and A3.

A number of sheets may be lodged for the one survey. All sheets must be the same size.

Plan information should not only comply with the general requirements of the S.O.M. but also with the Departmental Survey Instructions.

If the survey plan is not drawn in accordance with the Mineral Resources Act and Regulations it may be rejected. Presentation of plans representing surveys for mining grants see S.O.M. E2-131. See also Regulation 74.

Surveys of two or more leases may not be drawn on the one plan form unless each parcel is physically connected to the other by survey.

Presentation of plans for pipeline licences, see Part C.

The presentation windows marked with a bold outline at the foot of the plan, shall be completed by the Department. The co-ordinates shown shall be those at the centre of the plan face and shall have no meaning other than for location purposes. However if coordinates are determined accurately at a station, then that station number may be quoted.

Where there is more than one sheet per plan, to avoid confusion, co-ordinates shall be shown on and for the first sheet only. P.W.L. plans which show co-ordinates for survey points need not comply with this requirement.

In keeping with the concept of unique identifiers, land surveyed for mining purposes *other than claims, exploration permits, mineral development licences or mining leases* may be allocated a lot on plan description but the purpose should be described in tabular form on the face of the plan.

eg.

LOT	PURPOSE
1	Restricted Area No. 79

Plans drawn for the purpose of a grant must show a tenure table. To avoid confusion over the status of a grant, the description of a plan must not be qualified by the term "A" or "Application". The tenure table will be completed by the Department at date of grant or by the surveyor if the lease has been granted.

eg.

STATUS OF TENURE

TENURE	DATE OF GRANT
ML4059	

PLANNING PROVISIONS

The authorised use of land for a specified purpose under the Act shall, during the term of the lease, be deemed to be a permitted use of that land. Sec. 319.

Rezoning of the land therefore, is not a prerequisite for mining purposes.

Rezoning of land, subject to a mining lease, for other purposes shall be submitted to the Minister for his written views, Sec.319. Details of claim, licence or lease may be searched at the relevant mining registrar's Office whilst details of a mineral development licence may be requested through the Chief Executive, Sec. 319.

POSTS

The term refers to marks to be placed as required by the Act and mentioned at "Marking", p.35 and not to survey posts as required by the Departmental Instructions.

See also datum post p.21 and removal of posts p.42.

PRIORITY

Priority is referred to as one of the calls which effects the determination of boundaries at p.25 and is one of the considerations which effects the availability of land the subject of an application at p.14.

The details of priority have been listed under exclusions p.30 where clause 4 refers to the exclusion of prior applications or grants and clause 8 to the priority of lodgement of applications.

Priority of applications is set out in Secs. 63, 131, 185 & 251.

Priority (time) for registration of a document is outlined in Reg. 75.

REGISTRATION

Registration means the recording in the appropriate register of any transaction or dealing relating to a mining application or grant. See Regs. 13, 24, 30, 36.

The type of registers to be maintained are described in Section 387.

Registration of a survey plan refers to the acceptance of the plan and enrolment in the Departmental registrar for use in subsequent actions or dealings.

REMOVAL OF POSTS

If an application for a mining claim or lease is not made, or is rejected or abandoned any posts or alternative marks placed shall be removed. See Sec 60 and 244. If the land has been surveyed then the posts or alternative marks need not be maintained but survey marks must be left undisturbed. See Secs. 81(1)(m), 90, 274 and 276(1)(k).

The Mining Registrar may remove unwanted posts or alternative marks. Sec 342(1)(e)(ii).

The wilful removal or destruction of marks, alternative marks or posts shall be an offence. Reg. 65 and Sec.68 of the Surveyors Act.

See also datum post p.21 and posts p.41.

REPORT

The surveyor should disclose and report on:

- a) survey content
- b) survey irregularities
- c) relevant details of lease boundary irregularities, including reasons for departure from applicant's description/markings and/or major differences from original dimensions
- d) Any other circumstances which properly explained would help expedite the registration of the plan.
- e) Location of mine workings and installations as they may assist with positioning of the lease or claim.

The attachments required for Departmental Instructions could be lodged with the survey plan (and field notes if requested) and may form part of the report.

RESERVE

See Interpretation, Sec 5. The definition of owner relative to reserves should also be read.

An application shall not be granted over a reserve without the consent of the owner. See Exclusions Clause 2 p.30.

However, if the owner of a reserve refuses or withdraws consent to disturb the surface the Governor in Council may grant consent. Secs. 79(2), 129(10), 181(15) and 238(1).

A survey plan shall show by statement the proposed surface area within a reserve.

A road is classified as a reserve under the Act. Refer to *Road* at p.44.

RESTRICTED AREAS

The whole State or parts thereof described as Restricted Areas may be restricted in use by Regulation under Sec.391 of the Act. The restrictions enable the Department to set parameters to supplement the statutory provisions for mining within specified areas or to prohibit mining totally within those areas so that the land is reserved for Departmental, Government or other public or utilitarian purposes.

Restrictions may apply to applications, grants, terms, numbers held, areas and purposes of permits, licences, claims and leases.

Restricted Areas will appear on Merlin. Reference should be made to the Schedules in the Mineral Resources Regulation 1990 and Subordinate Legislation to the Mineral Resources Act for descriptions of Restricted Areas. The survey plan number may be quoted if applicable. Large Restricted Areas may conform to the sub-block descriptive method.

RESTRICTED LAND

Section 5 qualifies the definition of land for which an owner is required pursuant to Secs. 34, 51(2), 129(3), 181(8) and 238.

RESUMPTION

It is essential as part of the surveyor's search program that the state of the resumption be ascertained and shown accordingly in the action statement on the survey plan i.e. "Resumed" or "to be Resumed." The survey report should include the details of gazettal, where necessary. The action statement on the survey plan should also show the purpose of the resumption e.g "Resumed for Railway purposes."

When a mining claim or mining lease is involved, a survey plan must be lodged in the Department of Minerals and Energy. It is not sufficient where a resumption is involved that a plan be lodged with D.O.L. dealing with the background tenure only.

The Department plan should clearly show by presentation and action statement if necessary, whether roads, railways and other reserves have been resumed from the Surface Area or lease.

No provisions have been made for the resumption of land for the purposes of the Mineral Resources Act.

See also S.O.M. PART E2-142 (3.12.8).

RIGHT OF WAY

The S.O.M. at E2-143 (3.15) describes the methods which deal with rights of access for survey purposes under past legislation.

Refer to "Access" at p.12 for present requirements.

ROAD

Interpretation Sec. 5. For the purposes of the Act a road is also included under a reserve, but see also the definitions of occupied land and owner under the Act.

It is not possible to open or close roads on a plan of a mining survey. Such actions take place on the background tenures. However, whether by agreement or resumption such actions should also be shown on a survey plan lodged in the Department showing the effects on the surface area or lease.

Roads should be excluded from an application for, or a renewal of, a mining claim, or surface areas of a mining lease unless the consent of (a) the owner to include the surface of a reserve has been obtained or (b) the consent of the Governor in Council has been obtained, Secs. 54, and 238(1), and a compensation agreement lodged, Secs.85 and 279.

Where there is no surface area roads may be included or excluded from a lease but where they are included, then the roads are shown on the background tenure only. (D.M.E. Example No.1, M.L. 20099 shows a road as background tenure.)

Roads affecting surface areas:

Existing surveyed roads on the background tenure should be pegged at the intersections with the lease boundaries. Unsurveyed roads need not be pegged at the intersections excepting where doubt exists as to whether the unsurveyed road lies wholly or partly within the mining lease. The survey instructions will usually contain specific requirements in this regard.

Should more than one background tenure be involved, or where the whole of the surface is not required, a surveyed road should be pegged at all intersections and fully dimensioned using part compilation if necessary. In these circumstances an unsurveyed road should be fully surveyed, as is the case when a road either surveyed or unsurveyed is excluded from the surface area or the lease.

Where a road has been included in a surface area but not surveyed when the mining lease is surveyed, the area of the road(an about area if necessary) within the lease should be shown by statement on the plan.

For presentation of roads on mining lease plans See S.O.M. E2-144 (3.16).

See also Background tenures at p.17. and E2 -135 (3.2).

See also Access at p.12.

SEARCH

Clause 7(a) and (b) of Departmental Survey Instructions should be particularly noted. As a guide to information required, the following data may be obtained from the applicant, mining registrar's office, Department of Minerals and Energy or other plan or survey data registering authority, where appropriate.

- Certificate of Application
- Applicant's description
- Applicant's sketch or diagram
- Surface Area description and amendments
- Details of abandonment and or surrenders
- Departmental Lease File Information such as depth restrictions (through the mining registrar)
- Departmental Merlin print-outs (includes Exploration Permits and Proformas)
- Departmental Archival Charts
- Departmental Plans and Field Notes
- Cadastral Plans and Field Notes (DOL)
- Mining Claims, Specific Areas, Water Rights
- Permanent Mark and Geodetic Search

SUBJECT TO SURVEY

The term means "subject to the land being found to be available upon survey." See Exclusions p.30 and Priority p.41 which determine availability.

A certificate of application is normally granted subject to survey. Unless a prior survey has been effected a grant is made subject to survey and if issued, a lease is subject to a similar qualification. Provision exists under Sec 295(1)(a) to vary the boundaries and areas of a lease when survey information is subsequently provided.

SUBLEASE

A sublease may be approved by the Minister and a survey of the whole or part of the lease may be required. Sec. 300(5).

Apart from specific requests in the Departmental Instructions, surveys shall comply in all other respects with the Act and usual Departmental requirements.

SURFACE AREAS

Metalliferous and Coal

Certain areas are not available for Surface Areas without consent. These areas are defined in the Act and summarised under clause 2 of the exclusions at p.30.

A surface area being part only of a mining lease application need not be marked for application purposes, Sec. 240(2). It should be marked in the normal manner on survey of the lease.

The surface area of a mining lease application shall be identified, Sec. 245(1)(f) and described Sec. 246(c).

Note also that the description of the surface access within the mining lease boundaries shall include its abuttal to a surface area within the lease boundaries. Sec. 246(d).

The Warden's recommendation shall also consider the appropriate size and shape of the surface area. Sec. 269(4)(d).

An application for an addition to a surface area may be made at any time. Sec. 275.

An application for additional surface area not determined prior to the commencement of the Act, may be determined under the provisions of this Act. Schedule, Clause 3(13).

An application for a mining claim shall include the whole of the surface. Sec. 48(2).

Access via an adjoining lease held by the same person is necessary, if a surface area is not included in the application for a lease, Sec. 273. A survey may be necessary to prove the adjoinder.

A survey plan should be lodged for the partial surrender of a surface area and/or a mining lease, Sec. 309(2)(b), unless exemption is given by the Minister.

A survey plan may be required to show the balance of the land after a partial abandonment of a surface area of an application when a partial abandonment sketch has not preceded the lodgement of the plan prepared for the issue of the lease.

Notice in writing to abandon the whole or part of an application is required. Sec.307.

For the preparation of survey plans for surface areas in general, see S.O.M. E2-139 (3.12).

Petroleum and Gas

For surveys under Sec.37(iii) of the Petroleum Act the Chief Surveyor should be contacted.

SURRENDER

A total surrender may be lodged over:

Prospecting Permit	Sec. 37
Mining Claim	Sec. 107
Exploration Permit	Sec. 161

A total or partial surrender may be lodged over:

Mineral Development Licence	Sec. 210
Mining Lease	Sec. 309

But note that an EP may have to be reduced in area, Sec. 140.

A survey plan for a partial surrender of a mineral development licence may be requested by the Director-General. A survey plan for a partial surrender of a surveyed lease or an M.D.L. showing the balance area shall be lodged.

Unless directed under Section 407, a holder may lodge a request for exemption from the survey requirement in Sec.309(2)(b) where the lease is unsurveyed and a partial surrender is intended. However, in cases of alterations to unsurveyed leases, a survey of the lease and alterations is desirable to show the current situation.

The description and action statement on the survey plan should indicate whether a partial surrender effects the lease or surface area. The surveyor should verify the action with the lessee, since a surrender from the surface area does not mean a surrender from the lease.

A partial surrender of a mining claim may take effect in practice if an application for a new mining claim or lease is granted over part of an original claim over which a total surrender was lodged Sec. 107(6).

The preparation of survey plans for surrender actions is shown in the S.O.M. at E2-141 (3.12.7).

SURVEY

A survey is defined in the Surveyors Act 1977 and the Survey Co-ordination Act 1952.

A cadastral survey is also defined in the Surveyors Act 1977.

Surveys which comply with the above definition and which may be requested for the purposes of the Act are provided for at:

Section 299	Consolidation of Leases
Section 300(5)	Sublease
Section 309(2)(b)	Partial Surrender

Section 380	Warden's Court Order
Section 407	Minister's Request
Schedule, Clause 3(10)	ML granted under the Mining Act

Surveys which have been requested may have further effects under the provisions of:

Section 53(4)	Claim surplus area
Section 206	More accurate area defined for Mineral Development License
Section 210(2)(b)	Partial Surrender of MDL
Section 295	Variation to ML

Survey information which may be required to satisfy application provisions:

Section 14(1)	PP limits of application
Section 15	PP area
Section 51(1)	MC limits of application
Section 61(1)(d),(e),(f)&(g)	MC Application
Section 62	MC description
Section 129(3)(a)	EP limits of Application
Section 133(d)	EP Identification of Land
Section 181(8)	MDL limits of application
Section 183(d)(e)&(h)	MDL Application
Section 184	MDL Description
Section 238	ML limits of Application
Section 245(1)(d)(e)(f)(h)&(j)	ML Application
Section 246	ML Description

Renewal Surveys (as for mining leases) shall be effected by Licensed Surveyors in the way approved by the Minister. Sec.407.

Surveys for Petroleum Well Location. PART B.

Surveys for Pipeline Licence Locations. PART C.

Surveys for Departmental Purposes can include:

Datum Post locations. See datum post p.21
 Restricted Areas
 Investigation surveys
 Special requirements for miscellaneous surveys shall be outlined in Departmental Instructions

TENEMENTS

The Act no longer defines the term. A definition of mining tenement may be found in Sec. 7.1. of the Mining Act 1968, for the purposes of that Act.

For general tenure information, reference may be made to:
 Abbreviations p.11
 Interpretation Sec. 5 of the Act - "Act relating to mining"
 Schedule, Clause 2(1), 3(1)(a).

TITLES

Further details in the relevant Acts should be checked for the following titles issued by the Department.

Prospecting Permit:	No survey plan required
Mining Claim:	Survey plan only required if requested by applicant, grantee or the Minister
Exploration Permit:	No survey plan required unless requested by the Minister
Mineral Development Licence:	No survey plan required unless requested by the Minister
Mining Lease:	Survey plan could be required
Petroleum Lease: (Surface Area Only)	Survey plan required Sec 37(iii) Petroleum Act
Pipeline Licence:	Survey plans required (See PART B)

UNLODGED SURVEY PLAN

Should a survey plan not be lodged within the prescribed period of 60 days of the completion of the survey, a surveyor shall lodge a copy of the survey plan in the Department of Minerals and Energy, (Surveyors Regulations 28(2)).

The copy is enrolled as a Red Catalogue Numbered plan (Red Cat.). The Red Cat will be replaced by the survey plan when lodged.

A Red Cat is available for searching as a record of unexamined survey information only.

VARIATION

The surveyor should note that:

Provisions exist to vary a mining claim. Secs. 53(4) and 82.
 Conditions and boundaries may be varied on a mining lease. Secs. 294 and 295.

Access may be varied under Secs. 125, 231 and 317.

Variations to a Mining District under Part 2 could affect the surveyor

- (a) by administrative change to the point of lodgement.
- (b) by descriptive changes to the title block on a survey plan.

Variations to agreements in other Acts may affect boundaries or titles. Sections of those Acts referring to variations have been listed at pages 51-57.

WATER RIGHT

A water right, was a right to use the surface of the land for the purposes of water storage, conveyance and usage, pursuant to Part IV of the Regulations under the Mining Act 1898. The right is no longer issued by the Department, but may be perpetuated by franchise agreements. Old Water Rights may have influenced the land available to some existing mining lease or surface areas.

A search in the mining registrar's office or physical evidence on the ground may indicate whether a provision should still be made for water use by excluding an area from the surface area or lease or by setting special conditions over the lease.

Present usage diversion and appropriation of water is subject to the Water Act administered by the Water Commercial, Department of Primary Industries (WRC).

The preferred option to obtain water and/or other services may be obtained by application for a mining lease for carriage through or over land under Sec. 316.

In any case, queries relating to water rights should be referred to the Chief Surveyor.

Water Commercial issues a Water Works licence to draw water from a watercourse. The licence may be issued over adjoining lands upon production of a written agreement between the applicant for the licence and the land holder. (Details may be obtained from the Client Services Division, Commercial)

Note: Pursuant to Sec. 316 of the Act a lessee may apply for an adjoining lease for purposes other than, but associated with mining.

ADDITIONAL ACTS ADMINISTERED BY OR PERTAINING TO SURVEYS FOR THE DEPARTMENT OF MINERALS AND ENERGY

Knowledge of the following Acts may be required by the surveyor when undertaking survey work affected by the relevant act. The tabulation shows the act, the section and notes pertinent to that section which may be relevant to survey. When effecting surveys under a particular act, notwithstanding that instructions may be issued to effect surveys, the surveyor should familiarise himself with the whole of the particular act as sections and notes may not be tabulated.

The Acquisition of Lands Act and the Transport Infrastructure (Railways) Act have been included, as actions frequently carried out on background or adjoining tenures affect either conditions appertaining to mining or rights attached to surface areas or the whole of leases.

ACQUISITION OF LAND ACT 1967-1969.

Sec.4 Part I	Meaning of Terms
Sec.5(1)(a)PartII	Purposes for which land may be taken
Sec.5(2) Part II	Land required for incidental purposes
Sec.6 Part II	Easements
Sec.7 Part II	Notice of Intention to Resume
Sec.12 Part II	Effect of Proclamation
Sec.13 Part II	Action on small severance
Sec.14 Part II	Title dealing of affected land by resumption
Sec.15 Part II	Taking by agreement
Sec.36 Part V	Powers of Entry
Sec.41 Part V	Disposal of Land
Sec.43 Part V	Publication of Proclamation
Second Schedule	Purposes for which land may be taken

ALCAN QUEENSLAND PTY LIMITED AGREEMENT ACT.

Sec.1	Meaning of Terms
Sec.3	Variation of Agreement
Sec.4(2)(d)	Surveys
Sec.8	Term of Lease
Sec.9	Purposes of Lease
Sec.10	Form of Lease
Sec.11	Renewal of Lease
Sec.12	Number of Leases
Sec.17(d)	Areas of regeneration
Sec.22	Leases other than for designated Minerals
Sec.24	Special Perpetual Mining Purposes Leases
Sec.25	Other leases granted to Company
Sec.27	Surveys

Sec.33(a)	Exclusion from Local Authority Area
Sec.34	Separate Local Authority
Sec.35	Local Authority Provisions
Sec.36	Town Commission
Sec.43	Dedication of Roads
Sec.44	Additional Special Bauxite Mining Lease
Sec.46	Right of Access
Sec.47	Surrenders
Sec.55	Term of Lease
First Schedule	Description of Lease
Second Schedule	Conditions of Lease
Third Schedule Nos.1 & 2	Special Perpetual Mining Purposes Leases

AURUKUN ASSOCIATES AGREEMENT ACT 1975.

Sec.2 Part I	Interpretation
Sec.9 Part III	Surveys
Sec.19(2) Part III	limit of unrestored mining area
Sec.20 Part III	Surface rights to others
Sec.21 Part III	Mines Regulation Act to apply
Sec.23 Part III	Mining Lease for Coal
Sec.24 Part III	Renewal of Lease for Coal
Sec.26 Part III	Other Mining Leases
Sec.27 Part III	Special Mining Purposes Lease
Sec.3 Part V	Survey and Construction (Harbour Works)
Part VI	Town planning provisions including survey
Sec.8,9 Part VII	Land and Survey Provisions
Sec.10 Part VII	Road Dedication
Sec.10 Part VIII	Surrender
Second Schedule	Description

CENTRAL QUEENSLAND COAL ASSOCIATES AGREEMENT ACT 1968.

First Schedule	Description
Second Schedule Clause 3	Marking
Second Schedule Clause 4	Survey
Sec.1(5) and 1(6) Part III	Additions and Surrenders
Sec.2 Part III	Limit of number of leases
Sec.6,11 Part III	Surveys
Sec.25 Part III	Grant of lease
Part VIII	Provisions relating to land
Sec.2(2) Part IX	Acquisition by Minister
Sec.4 Part IX	Acquisition by Company
Sec.5(3) Part IX	Grant of leases
Sec.13 Part IX	Zoning

COAL MINING ACT 1925 AND PRINCIPAL RULES 1985

Sec.46	Drainage Plans
Sec.57	Certificates
Sec.57D 57E	Mine Surveyors Certificate
Rule 6	Surveying Experience
Rule 8	Certificate Application
Rule 9	Examination requirement
Rule 10	Examination exemption
Rule 11	Recognition of qualifications

COMMONWEALTH ALUMINIUM CORPORATION PTY LIMITED
AGREEMENT ACT OF 1957.(References below are to the Schedule)

Sec.1	Meaning of Terms
Sec.4(2)(b)	Investigations Surveys
Sec.8(a) & 8(b)	Term of Lease
Sec.9(a) & 9(b)	Area of Lease
Sec.10	Purposes of Lease
Sec.13	Areas of Lease
Sec.16(b)	Surrenders
Sec.19	Restoration of Surface Area
Sec.25	Title for other minerals
Sec.27	Special Perpetual Mining Purposes Lease
Sec.28	Grant of other leases
Sec.30	Survey Requirements
Sec.31	Resumption for inundation
Sec.37	Harbour Survey
Sec.43	Areas to be set aside
Sec.44	Constitution of separate Local Authority
Sec.45	Local Authority constraints
Sec.46	Construction of Local Authority
Sec.53	Dedication of Land
Sec.54	Application for lease elsewhere in field
Sec.56(a)	Right of Access
Sec.56(b)	Use of Roads
Sec.57	Surrenders
Sec.58(a)(vi)	Neglects to Surrender
Sec.60	Reference to Tribunal
First and Second Schedules	Descriptions of Leases
Fifth Schedule Nos.1 & 2	Special Perpetual Mining Purposes Lease

GREENVALE AGREEMENT ACT 1970

Sec.2	Meaning of Terms
Part III	Special Minerals Leases
Part VII	Provisions Relating to lands
Sec.4 Part VIII	Value of Lands
Sec.7 Part VIII	Provision of Services
Sec.10 Part VIII	Zoning
First Schedule	Special Mineral Lease
Third Schedule	Railway Route
Fourth Schedule	Water Use Boundaries

GENERAL RULES FOR UNDERGROUND COAL MINES 1983

Sec.54.1	Mines Working (Not Cadastral) Plans
Sec.54.2	Mines Working (Not Cadastral) Plans

METALLIFEROUS MINING REGULATIONS 1985

Sec.13.10	Certificate qualification
-----------	---------------------------

MINERAL (SUBMERGED LAND) ACT 1981 (Commonwealth)**MINES REGULATION ACT OF 1964**

Sec.5 Part I	Meaning of Terms
Sec.6(1)	Application of Act
Sec.9(3) Part III	Board of Examiners
Sec.11(8) Part III	Mine Survey Certificate
Sec.13 Part III	Fences
Sec.15(2) Part IV	Inspection of Mines
Sec.45 Part IV	Action against Certificate holder
Sec.51 Part IV	Survey of Underground workings
Sec.52 Part IV	Viewing of Survey Plans
Sec.53 Part IV	Applications to Warden to enter a mine
Sec.54(1)(k) Part V	Regulations
Sec.121-128 Part VI	Signals
Part XI	Certificates

MINING (FOSSICKING) ACT 1985**MOUNT ISA MINES LIMITED AGREEMENT ACT 1985**

Sec.2 Part I	Meaning of Terms
Sec.2 Part II	Mining Lease Provisions
Schedules AtoG	Descriptions and Agreements

OPEN CUT COAL MINE SPECIAL RULES

Rules 66-70

Duties of Surveyor

PETROLEUM ACT 1923-1988

Sec.3 Part I	Interpretation of Terms
Sec.6 Part II	Reservations in Crown Grants
Sec.8 Part II	Land may be resumed
Sec.9 Part III	Grant of permits and leases and excluded area
Sec.9A (2) Part III	Survey Fee
Sec.14(3) Part IV	Plan for Application for permit Unsurveyed land may be surveyed
Sec.19 Par IV	Marking the land
Sec.28 Part V	Grant of Leases
Sec.29A Part V	Grant of Leases to others than holders of A to P or permit
Sec.31 Part V	Form and Term of Lease
Sec.37(i) Part V	Use and occupation of mining
Sec.37(iii) Par V	Survey of surface area
Sec.38	Surrender of lease
Sec.44(a) Part VI	Rights reserved easements and rights of way
Sec.45(2) Part VI	Permission to enter lands
Sec.45(3)(a) Part VI	Grant of licence
Sec.45(4) Part VI	Consent to deal with land granted or licensed
Sec.45A(2) Part VI	Grant of easement over Crown Land
Sec.45A(4) Part VI	Use of pipeline without rights to land
Sec.45B Part VI	Acquisition of land and compensation
Sec.45C Part VI	Rights of license
Sec.45D Part VI	Crossing of railways roads etc
Sec.45E Part VI	Registration and effect of easements
Sec.45F Part VI	Petroleum Product Pipelines
Sec.48 Part VI	Restriction on location of drills
Sec.54A Part VI	Powers of "The Secretary for Mines"
Sec.56 Part VI	Right to mine for other minerals
Sec.59 Part VI	Compensation
Sec.60 Part VI	Power to agree to Compensation
Sec.61 Part VI	Measure of Compensation
Sec.61(A) Part VI	Union of Leases
Sec.62(A) Part VII	Reference to Geodetic Datum

PETROLEUM REGULATIONS (LAND) 1966

Regulation 5	Meaning of Terms
Regulation 117	Location Survey
Regulation 128	Adjacent sub-surface mine connections
Regulation 129	Adjacent Boundary Connections

PETROLEUM (SUBMERGED LANDS) ACT 1982.

Sec.8	A.G.D. for reference point
Sec.17	Graticulation (block description)
Sec.38	Adjacent blocks
Sec.64	Pipeline Licence Application
Sec.65	Pipeline Licence Grant or Refusal
Sec.100	Drilling proximity to boundaries
Sec.121	Survey of wells

QUEENSLAND CEMENT AND LIME COMPANY LIMITED AGREEMENT ACT 1977.

Schedule A	Description
Schedule B	Freehold Description
Schedule C	Pipeline Route

SURVEY CO-ORDINATION ACT 1952**THE MINERAL RESOURCES (ADJACENT SUBMARINE AREAS) ACT OF 1964.**

This Act reasserts the application of The Coal Mining Acts and The Petroleum Act with respect to the exploration of the sea-bed and sub-soil.

Sec.6 Exemptions or amendments to land by Orders in Council**THIESS PEABODY MITSUI COAL PTY LTD AGREEMENT ACTS 1962-1965**

Sec.2 Part I	Interpretation
Sec.4 Part I	Variation of Agreement
Sec.7 Part II	Right to Prospect for Coal
Sec.8 Part II	Surrender of Portion of Lands
Sec.9 Part II	Variation of Lands in First Schedule
Sec.15 Part II	Conditions re prospecting on Private Land
Sec.18 Part III	Grant of Special Coal Mining Lease
Sec.19 Part III	Purposes of Coal Mining Lease
Sec.21 Part III	Conditions re Private Land
Sec.23 Part III	Term of Special Coal Mining Lease
Sec.26 Part III	Surveys
Sec.31(d) Part III	Area of affected land
Sec.32 Part IV	Survey of Railway Route
Sec.33 Part IV	Company to make Railway
Sec.35 Part IV	Railway Route Plans
Sec.37(4-8) Part I	Company Rights to Railway Lands
Sec.40 Part IV	Width of land for Railway
Sec.42(2)(3) Part IV	Substituted Road Widths
First Schedule	Description of Area

TRANSPORT INFRASTRUCTURE (RAILWAYS) ACT 1991

Sec. 6.5	Accommodation Works
Sec. 6.6	Land may be taken
Sec. 6.7	Small parcels of land
Sec. 6.8	Land vests in Qld. Railways
Sec. 6.9	Taking Crown Land
Sec. 6.10	Title under repealed Act
Sec. 6.14	Railway may be road or reserve
Sec. 6.15	Width of roads
Sec. 6.16	Closure of roads
Sec. 6.18	Extension of certain roads
Sec. 6.21	Construction works on Qld. Rly. land

TRANSPORT INFRASTRUCTURE ACT 1994

TRANSPORT OPERATIONS (ROAD USE MANAGEMENT) ACT
1995

PART B

REQUIREMENTS ASSOCIATED WITH THE PETROLEUM ACT 1923 AND PETROLEUM REGULATIONS (LAND) 1966

PETROLEUM WELL LOCATION

ACCURACY

(a) Horizontal Control (R.117)

The connection to horizontal control will not exceed an equivalent accuracy of 1 in 4000 for a closed traverse. Unclosed traverses should be noted by the surveyor in the Field notes or report, as having been check measured, and be supported by a sufficient explanation of the survey methodology to demonstrate that the accuracy specification has been met.

(b) Vertical Control (R.117)

The difference in two level runs by spirit or trig. levelling shall not exceed $0.12 \sqrt{K}$ metres where K is the distance in kilometres from the well to the established bench mark.

APPROVAL

(a) Alternative Survey Methods, Control Points.

Where doubt exists as to the acceptability of a proposed survey method or a proposed survey control point, the Chief Surveyor, Department of Minerals and Energy should be contacted in writing setting out all the relevant details for his approval or otherwise.

(b) To Carry out Petroleum Well Location Surveys.

Regulation 117(1) of the Petroleum Regulations (Land) 1966, requires that the location and elevation of a well be determined by survey by a person approved by the Minister.

Persons seeking approval to perform Petroleum Well Location Surveys should apply in writing to the Chief Surveyor, Department of Minerals and Energy. The application should outline the applicant's qualifications and experience. Approval is then at the discretion of the Minister.

Approval is generally consistent with registration of the applicant by the Surveyors Board of Queensland or in some cases its interstate equivalent. In cases where it is planned to use cadastral boundaries for location of a Petroleum Well, proof of cadastral experience may be required.

BENCH MARKS - (R.117(1)(d))

A vertical connection should be made from the well to a new suitable permanent bench mark established within 200m of the well. A suitable horizontal Reference Mark may be used as the bench mark. The accuracy should comply with that stated above.

BOUNDARIES - (R.129)

A relationship to any adjacent Petroleum Title Boundary within 1.61 kilometres (1 mile) of a well is required.

Sec.48 A relationship is required to any boundary on a Petroleum Prospecting Permit, Petroleum Lease or Authority to Prospect (administered as Petroleum Exploration Permit) on which the well is situated and which is within 60m of that boundary.

In most cases these boundaries are defined by unmarked parallels of latitudes and longitudes only, and a calculated connection may be made.

CADASTRAL CONNECTION - (R.117)

The location of a Petroleum Well may be effected by connection to the cadastral network (See Approval - To carry out Petroleum Well Location Survey p.56) and the co-ordinates of the well then scaled from an approved map (See Co-ordinates below).

CERTIFICATE - Surveyors

The new Minerals and Energy plan form provides the appropriate certificate on the reverse side. The relevant window on the face of the plan should also be completed. The old plan forms may be used until stocks are exhausted. See example in S.O.M. E2-136 (3.3.2).

CO-ORDINATES - (S.61)**a) General**

Geographic and A.M.G. co-ordinates of the Well are required for all Petroleum Well Locations.

Co-ordinates should be shown in accordance with the current S.O.M. and clearly labelled AMG-84(66), AGD-84(66) as appropriate.

b) Methods

(i) **Calculation:** Although Petroleum Well Location Surveys may be of the accuracy referred to on p.56, the aim is to generate the best possible co-ordinates from the available data. To achieve this, calculations should be performed in accordance with the National Mapping Council Special Publication 10, "The Australian Geodetic Datum, Technical Manual". Formulae from other sources may be used, but should be included in the field notes with the calculations.

(ii) **Scaled:** When co-ordinates are obtained by scaling from an approved map *by a cadastral connection* they should be shown to plotting accuracy, that is, the nearest 0.5 seconds in latitude and longitude and the nearest 10 metres in A.M.G. A statement should be shown on the face of the plan stating that the co-ordinates have been obtained by scaling from a map (show the approved map name and scale).

- (iii) Transformation: Only one set of co-ordinates may be scaled per plan with any other co-ordinates being derived mathematically from that set.
- (iv) Translocated: When co-ordinates are derived by an approved translocation technique using satellite surveying methods, a statement to that effect giving a description of the origin of the translocation should be shown on the face of the plan.

The co-ordinates and description of the origin used are to be shown on the plan in cases (i) and (iii).

DATUM

Datum should be clearly shown where a cadastral connection is used. For other cases see Origin p.62 and Meridian p.62.

DESCRIPTION - Property (see Tenure) p.63.

DISTANCE

Where a location is carried out by means of a connection to a Geodetic Network, it should be clearly stated whether distances are reduced to spheroid at Terrain Height, or at some other specific elevation.

DOCUMENTATION - (R.117)

The Regulations require that a plan and field notes be lodged with the Department within 3 months of the completion of the survey. An Oil Well Location Reference Marks Sketch Plan is also required to be lodged.

The plan is to be drawn on a standard Department of Minerals and Energy plan form showing all relevant horizontal location information. The old plan forms may be used until stocks are exhausted.

Complete field notes containing horizontal and vertical location information, meridian observations, details of origins (horizontal and vertical) and reports or comments by the surveyor on the survey are required. The field notes should be unambiguous in the co-ordinate datum used and nominate co-ordinate transformation parameters used.

An "Oil Well Location Reference Marks Sketch Plan" (blank forms available from the Chief Surveyor) is required to show all elevation details including the level of the Well and Bench Marks placed, a description of the mark used for level datum and its value, the method used to determine the height and the location of reference and Bench marks placed at the Well.

If a permanent mark is placed during the course of the survey, it is the surveyor's responsibility to lodge a permanent mark sketch plan (Form 6) (under the Survey Co-ordination Regulations) with the Department of Lands. A copy only should be lodged with the Department of Minerals and Energy.

DOPPLER

See Satellite Surveying Methods p.63.

DRAFTING

All plans should be drawn in accordance with the procedures outlined in the current Survey Plan Guidelines. Additional information which may be shown is available on example plans, copies of which are obtainable from the Chief Surveyor.

ELEVATION - (R.117)

(a) The elevation of a well is to be related to A.H.D. and may be derived in a number of ways.

- (i) Spirit levelling
- (ii) Trigonometric levelling using reciprocal vertical angles and E.D.M.
- (iii) Satellite derived methods (See Satellite Surveying Methods p.63).
- (iv) Barometric Heighting - previously, when no established control was located within 80 kilometres of a well, a surveyor could apply to the Chief Surveyor for approval to establish the elevation of a well by Barometer. However, since the introduction of satellite surveying technology and a more extensive network of control available, approval for barometric heighting is no longer given.

(b) Accuracy - See Accuracy (b) Vertical Control p.58.
All details of the levelling for the well are recorded either in the field notes or on the Oil Well Location Reference Marks Sketch Plan (see Documentation p.60).

FEEES

A lodgement fee as determined from time to time shall be paid with the lodgement of each plan.

FIELD NOTES - See Documentation p.60.

G.P.S. - See Satellite Surveying Methods p.63.

HEIGHT - See Elevation p.61.

INTERPRETATION OF TERMS. Reg.5 Part 1.

LEGISLATION

Provisions of the Petroleum Act 1923-1988 and the Petroleum Regulations (Land) 1966 state the survey requirements for the location of a well.

LOCATION

- (a) **General:**
To show the general location of a Well, a locality sketch and/or speedo traverse should be shown on the plan. This is not necessary if connections to cadastral boundaries, occupation and other distinctive features in the vicinity of the Well are shown.
- (b) **Surveyed: R(117)**
A connection to the cadastral or geodetic network by traverse, other terrestrial survey methods, Doppler or G.P.S. translocation is acceptable if it can be shown to meet the specified accuracy standards. (See Satellite Surveying Methods p.63).

MAP REFERENCE - See Co-ordinates (scaled) p.59.

MERIDIAN - (R.117)

The meridian of the survey is to be shown in the appropriate box in the Title Block and should be related to A.M.G. However the meridian adopted from connections to cadastral boundaries may be acceptable.

MINES - (R.128(3))

A horizontal connection to known subsurface mine workings within 3.2 kilometres of the well is required.

NAME OF WELL

The name of the well is the primary identifier of the well recorded and therefore it is paramount that it be shown correctly on all documentation.

OCCUPATION AND IMPROVEMENTS - (Reg.117(2))

A connection to all other wells, roads, railways, fences, public utility services, building or structures within 200m of the well is required.
Reg.128(1)

Limitations to the drilling of wells near improvements is stated. Therefore connections in accordance with Reg.117(2) are required.

OIL WELL LOCATION REFERENCE MARKS SKETCH PLAN - (R.117) - See Documentation p.60.**ORIGIN**

For the calculation of co-ordinates the descriptions and values of the points from which these co-ordinates were derived should be shown on the plan.

PETROLEUM TITLE BOUNDARIES - See Boundaries p59.**PLANS - See Documentation p.60.**

POINT POSITIONING

Single point positioning by Satellite Surveying is not an acceptable method of location. *That is, all connections must be closed.*

PROPERTY DESCRIPTIONS - See Tenure p.63.

REFERENCE MARKS - (R.117 (1)C)

The well shall be tied for horizontal control to two suitable permanent reference marks within 200m (10 chains) of the well. One or both of these marks may be utilised as a Bench Mark for elevation control if suitable.

REGULATIONS - See Legislation p.61.

RELATIVE POSITIONING - See Satellite Surveying Methods p.63.

REPORT

The surveyor may include with the field notes a report on the location, as well as any other aspects, clarification of which would expedite the registration of the plan.

REQUISITIONS

The Department may request further information from a surveyor to satisfy the requirements of Reg.117.

SATELLITE SURVEYING METHODS

Horizontal and vertical control by G.P.S. or Doppler should comply with the standards and specifications referred to in the current draft of the "Inter-Governmental Advisory Committee on Surveying and Mapping, Standards and Specifications for Control Surveys" at a standard necessary to achieve the accuracy referred to on p.58.

If Satellite Surveying Methods other than GPS are used to provide Co-ordinates, and an acceptable A.H.D. height is available at the horizontal control station used as the Co-ordinate datum, then the level derived for that well by a translocation process may be used for height determination, providing no established bench mark exists within 8 kilometres of the well.

See also GPS at p.33.

TENURE

All current tenures, particularly any Authority to Prospect or Petroleum Lease, over the property on which the well is located, should be shown on the documentation. (see also S.O.M, Exploration Permit E2-137)

TIME LIMITATIONS - (R.117)

Regulation 117 requires that as soon as practicable and not later than 6 months of the spudding of a well the location and elevation of the well be determined by survey by a person approved by the Minister (see Approval, p.58). Further, the regulation also requires that as soon as practicable and not later than 3 months after the completion of the survey for location and elevation of a well, the operator shall submit to the Chief Surveyor a plan (see Documentation p.60) certified as to the accuracy by the person who made the survey.

WELL - For meaning of term see Reg.5(1)

PART C

PIPELINE LICENSE LOCATIONS

Pipeline License Location (PPL) Plans are usually required by the provisions of a Pipeline License granted under S. 45(3) of the Petroleum Act 1923-1988. The land is acquired and the pipeline constructed and operated under Secs. 45A to 45F. To determine what types of plans are specified for a particular license it is necessary to refer to the clauses of the actual pipeline license document.

Generally the pipeline license documents describe a set of plans for each license, made up of 3 series of plans, as follows:

(a) Key Plan

The Key Plan serves as a reference map and may be:

one or more sheets, based on published small-scale cadastral mapping at appropriate scale or scales, bound loose-leaf in series into a suitable cover, and should show:

the undimensioned boundaries of the "route of pipeline" as granted and described in the Schedule to the License in relation to the cadastre, within which the pipeline is to be constructed,

the plotted position of the full extent of the pipeline, as laid, between "terminal points",

the name or description of the terminal points,

plan catalogue numbers for all of the plans of lands (freehold or Crown leasehold) held by the licensee for the purposes of the Pipeline License

RP and/or DOL plan catalogue numbers for all of the pipeline easement plans,

a drawing reference number for all plans of "pipeline crossings" over roads, railways, watercourses, foreshores, Unallocated State Land, etc. (i.e. all public lands crossed by the pipeline not covered by a registered easement),

Reference to the drawing numbers of the As-Constructed Engineering Plans,

Provisional AMG Co-ordinates of terminal points and at each major change of direction in the horizontal alignment of the centreline of the pipeline

An endorsement to the effect that the Pipeline License is reduced to the corridor width shown on the plans of lands, easements and pipeline crossings in the Pipeline Location Book upon the Minister's acceptance of those plans and their registration in the Department of Minerals and Energy.

The Key Plan usually requires the approval of the Chief Surveyor, under the terms of the License.

(b) Pipeline Location Book

The Pipeline Location Book is essentially a cadastral survey record of the pipeline location, and should consist of:

copies of registered easement plans for all private land and Crown land subject to the Pipeline License, together with proof of registration of the easement documents,

copies of registered plans of any other lands acquired for the purpose of, and covered by the Pipeline License, together with proof that such lands are held by the licensee,

copies of drawings to the same standard as easement plans for surveys of all pipeline crossings, as defined in the License, certified as to their accuracy by a Licensed Surveyor,

copies of all Permanent Mark Sketch Plans (Forms 6) prepared in connection with the License,

and should show:

the surveyed and dimensioned location of the centreline of the pipeline, as laid, with respect to property boundaries, continuously between terminal points,

provisional AMG Co-ordinates for at least two points on each plan.

All plans in the Pipeline Location Book are to be suitably indexed and bound in the series.

The series of plans in the Pipeline Location Book is usually required in the terms of the License to be accepted by the Minister and registered by the Department.

All plans in the Pipeline Location Book are to be suitably indexed and bound in the series.

(c) As-Constructed Engineering Plans

The As-Constructed Engineering Plans become a public record of the actual pipe location with respect to surface and underground physical features, and should consist of:

a plan (or plans) to a convenient scale approved by the State Mining Engineer of the horizontal alignment of the position of the pipeline, as constructed, in relation to road and railway formations, rivers and streams, fences, underground pipelines and cables, electricity transmission lines and other structures adjacent to the pipeline, together with the location of all valves, pumping stations, storage tanks and other facilities being part of, or in connection with the pipeline. An orthophoto map or air photo mosaic would be an acceptable base for the plan.

a longitudinal section, preferably to the same horizontal scale as the horizontal alignment plan, with an exaggerated vertical scale, showing the vertical alignment of the as-constructed pipeline in relation to the same points of detail as required for the horizontal alignment plan.

In addition:

depth of cover over the pipeline must be able to be determined,

provisional AMG Co-ordinates are required for the terminal points and each major change of horizontal direction of the pipeline,

heights are to be related to AHD,

the horizontal and vertical alignments may be shown on the same sheets,

the sheets may also show, in separate longitudinal rows, other relevant administrative, geographic or construction details as may be required by the licensee,

the sheets are to be bound, loose-leaf, in series.

It is also noted that Sec.62A of the Act (inserted 1967) provides that, where the position of any point, line or area is required for the purposes of the Act it shall be referred to the AMG.

PURPOSE OF PLANS

The purpose of the prescribed plans would appear to be to provide, (and, in the public interest, should provide) ready public access to information regarding:

- (a) the location of the Pipeline License boundaries,
- (b) references to the tenure by which the lands the subject of the License are held, and
- (c) the accurate location of the pipe.

PART D

SURVEY INSTRUCTIONS

The following instructions are an example of standard instructions issued pursuant to Sec.407 of the Act. They may be altered without notice.

In a particular instance, specific instructions may be included apart from the standard instructions 1-18.

Dear Sir,

Re: Survey of Mining Lease No. * Named "*" "
Mining District of *

In response to your letter of * you are advised that the following instructions 1-18 are issued for the survey of the above lease. Surveys are to be effected in accordance with the provisions of the, Mineral Resources Act 1989 and Mineral Resources Regulations 1990. In particular, attention is drawn to Regulation 74.

The survey is to be carried out personally by, or under the direct personal supervision of, the approved surveyor to whom these instructions are issued.

SURVEY

1. All requisitions on survey are to be attended to promptly by the surveyor.
2. The meridian and location of the lease surveys shall be related by closed traverse connections to the boundaries of all background tenures involved. Severed areas of any lease must be provided where a lease straddles a background boundary. Where previous mining leases are connected to and have been tied into background boundaries then the Surveyor is required to supply any details in his report.
3. The meridian is to be related to A.M.G. Details should be shown in accordance with the current S.O.M. The survey shall be/ need not be connected to recognised A.M.G. co-ordinated stations.
4. Where apparent installations such as pipelines, power lines and Telecom facilities on the subject land, or so situated as likely to be disturbed by mining operations, are to be located and shown. Where natural features and improvements such as creeks, tracks and fences are intersected by the lease boundaries they should be shown.

5. Details of any unique features of historical significance could be located and documented in the survey report. e.g. chimney stacks, crushing mills etc.
6. Alternative methods of survey such as photo point identification may be used only with prior permission.
7. The surveyor shall ensure that all relevant details are known so that the survey may be properly effected.
 - (a) The surveyor shall be responsible for the search information, a copy of which may be forwarded directly to the Department of Minerals and Energy Brisbane to expedite the registration of the plan. The search information will be returned to the surveyor upon his written advice.
 - (b) Upon receipt of these written instructions the surveyor shall ensure that the application description, sketch, and details of surface area, abandonments or surrenders are obtained from the applicant or lessee and the district mining registrar's office.

BOUNDARY CONSIDERATIONS

8. **Priority of Application.** Attention must be given to the chronological priority of all mining claims, mining leases, mineral development licences, exploration permits and applications in the locality to determine the availability of land for each application under survey.
9. **Encroachment of Claims.** Reference should be made to Page E4-18 to determine how a mining claim may be dealt with under the provisions of the Mineral Resources Act. Should the determination of a surface area or boundary of the mining claim, mining lease, mineral development license, exploration permit, the subject of these directions, await a decision of the district mining registrar or warden under those provisions, immediate action should be taken as recommended.

A statement of findings in the registrar's office and evidence located on the ground should be included in the survey report. A copy of any relevant mining claim, application, description, or sketch should be included in the search information at 7(a).
10. Every endeavour must be made to contact the applicant/lessee (or authorised person) of the mining claim, mining lease, mineral development licence, exploration permit or application under survey and have that person point out the datum post and/or commencement point and application posts. Where encroachments or disputes could possibly arise the surveyor must also contact all applicants, holders and land owners affected in order to clarify applications and grants.

All landholders affected by the survey are to be contacted and made aware of the requirements necessary to effect the survey.

11. The location of datum posts and application posts of the subject and adjacent leases and claims and the markings thereon are to be recorded.

Chronological order of marking that can be expected under the various Acts is shown at Page E4--23.

Should the applicant of an adjacent claim or lease be entitled to shift his datum post under the provisions of the Mineral Resources Regulations 16 and 40 the surveyor should notify the district mining registrar of the adjacent claims or leases so entitled.

12. Evidence to support the location of the claim, lease, permit, licence or application (for example, old shafts or mine workings) should be recorded in the survey records.
13. Any surveys of a mining claim or mining lease carried out prior to a Warden's Court Hearing will be subject to his findings.
14. Mining claims, mining leases, mineral development licences, exploration permits and applications are to be marked with survey posts or *equivalent marks* where survey posts are unable to be placed. *Equivalent marks* would be a cairn of rocks, painted star picket in concrete or other similarly prominent mark. Corner reference trees are to be taken wherever possible at each corner in conjunction with other reference marks. Shields are to be chiselled with the appropriate Minerals and Energy description. Where reference trees are not available survey posts should be likewise permanently and clearly branded. *Equivalent Marks* should also be suitably marked.
15. Where Permanent Marks are required to be placed on this survey, Forms 6 are to be prepared by the surveyor as required by the Survey Co-Ordination Act 1952. Copies only should be forwarded to the Department.

PLANS

16. Plans are to be drawn in accordance with the general requirements of the S.O.M. Refer also to Page E4--40.
17. Once the survey plan has been passed correct, arrangements could be made to refund outstanding survey fees lodged under prior legislation to the M.R.A.

LODGEMENT

18. Plan(s), field notes, report, calculation sheets, Survey Record sheets and copies of Form 6's are to be forwarded to the Chief Surveyor, Department of Minerals and Energy Brisbane or the respective mining registrar's office and be accompanied by the appropriate lodgement fee.

Yours faithfully,

J. D. Bell
Chief Surveyor
Survey Unit
Tenures & Mineral Development Branch

This page intentionally left blank.

- 4

PART E

MINERAL DEVELOPMENT LICENCE SURVEYS

CAUTION

The survey of an MDL or an application for an MDL is not to be treated as an extraordinary survey. Part A, General Requirements, and Part D, Survey Instructions, should be read as well as Part 6 of the *Mineral Resources Act 1989*. An MDL is to be done to the same standards of marking, measurement and reinstatement as a mining lease.

OUTLINE

Unless otherwise approved by the Minister pursuant to section 226(3), a mineral development licence in respect of a mineral occurrence may be applied for by an eligible person in respect of land which, at the time the application is made, is comprised in -

- a) an exploration permit; or
- b) a mineral development licence (Sec. 179)

Note also Sections 182, 183 and 184.

The purpose of the licence is to allow activities to be carried out to evaluate the economic development of an ore body. The term is usually short, but the grant is renewable. An application for an MDL does not have to be surveyed, but the applicant, the holder, or the Minister pursuant to section 407 of the Act, may request a survey.

An MDL must sit within the prerequisite EP or pre-existing MDL. Similarly, any subsequent mining lease that arises out of the subject MDL must sit within the MDL boundaries. If either the MDL or the ML overlap the available land (ie. the pre-requisite tenure), the overlap at least is not available, even after grant. At the worst, the whole grant may be at risk.

MARKING

No ground marking of an MDL application is required by the Act. If ground marking, such as a datum post, is placed, its legal significance is not certain. If it is placed accurately by a licensed surveyor and referred to survey marks, it could come under the alternative description provisions of section 184 of the Act. See also E4--35.

DESCRIPTION

Section 184(b) of the Act says "the boundaries of the mineral development licence shall be described by accurately measured distances and compass bearings or other method acceptable to the chief executive". 184(A), (c) and (d) have similar provisions.

The meridian of MDL boundaries is critical. Since MDLs are fixed by description, a small swing in a long boundary could shift parts of the MDL off the desired land. This can be very expensive if mineralised land is excluded. The use of a compass over long distances may produce unusable results.

Using theodolite, chain, EDM or GPS are acceptable alternative methods of measurement. If the meridian is not magnetic, it should be on a recognised system such as AMG, and a conversion factor to magnetic meridian must be supplied.

For an alternative method of description to be acceptable, the boundaries must be capable of being reproduced unambiguously at some time in the future.

Adopting a surveyed boundary of a cadastral parcel that is shown on a registered plan is one example of an acceptable alternative description. Another is the adoption of geographical or Australian Map Grid coordinates. In this case, the bearings and distances between the corners must also be provided.

Care should be taken when both cadastral boundaries and coordinates are used to describe the same MDL. Background mapping should be carefully checked before it is used, as many Queensland maps do not have a good relationship between the cadastre and the latitude and longitude.

Note also that scaling from maps is not an acceptable alternative method of description.

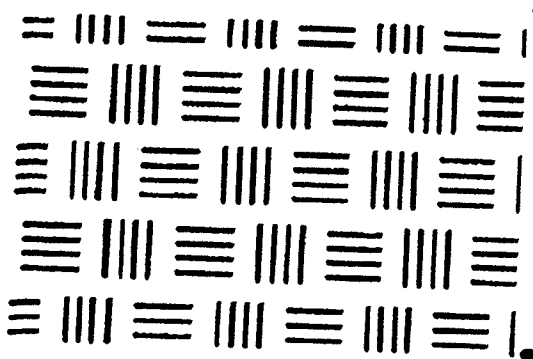

Part E5

Survey Requirements of the Department of Main Roads

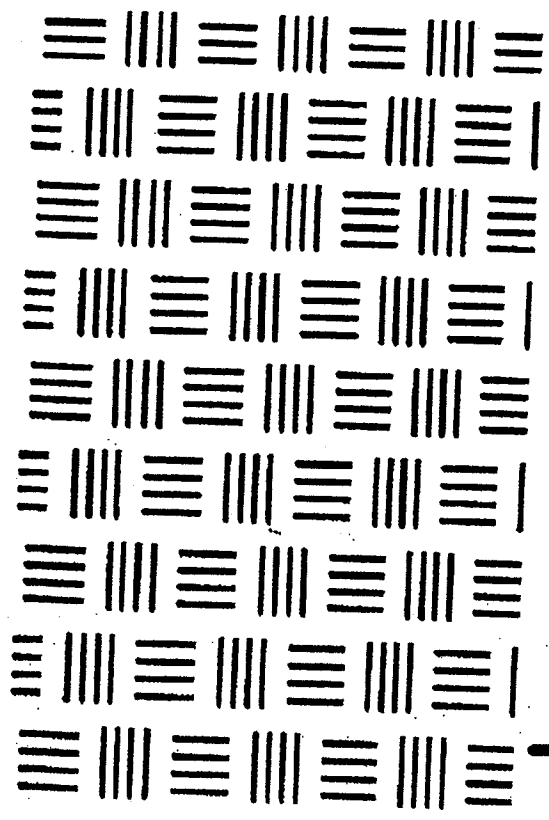

Outlining the requirements as set down by the
Department of Main Roads.

Department of Main Roads

**G.P.O. BOX 1412
BRISBANE QLD 4001**

**Phone: 3834 2474
Fax: 3834 2998**

Att: Principal Surveyor

IMPORTANT NOTE

Should a conflict arise between these Guidelines and various Acts and Regulations referred to, then the provisions of those Acts and Regulations will prevail. The Guidelines shall not be taken as a substitute for detailed professional advice.

© Copyright Reserved

Guidelines or parts hereof must not be reproduced without permission

DEPARTMENT OF MAIN ROADS: ENGINEERING SURVEYS ON STATE CONTROLLED ROADS

Engagement of Surveyors

Surveyors are engaged

- ◆ by the Department of Main Roads in accordance with the State Purchasing Policy,

OR

- ◆ by private sector Project Managers/Contractors acting on behalf of the Department,

to undertake engineering surveys on State Controlled Roads.

Specifications

The Department of Main Roads provides detailed specifications when it issues a brief for engineering surveys. The specifications cover the technical and safety aspects of engineering surveying on State Controlled Roads and other associated matters such as entry on to private land.

The technical requirements for each project vary and the specifications are customised to accommodate these variations.

Stringent safety requirements apply to all Main Roads Department projects. These must be observed whenever work is being undertaken on State Controlled Roads even if such work is being undertaken as a subcontractor.

Departmental safety requirements vary between engineering districts and according to classifications of the road and the traffic conditions. It is essential that the appropriate District Safety Officer be contacted prior to entering upon a State Controlled Road to undertake survey work. Any special requirements for the section of road, which is the subject of the survey, can then be established and implemented.

Work Place Health and Safety Requirements

The Department's requirements in Workplace Health and Safety are set out in the following extract from the Engineering Survey Specifications and these should be observed at all times.

4.0 Workplace Health and Safety

Main Roads, its staff and its agents have an obligation to comply with all applicable statutory legislation.

A failure to comply with the safety standards required is considered unacceptable to the Department, and grounds for the termination of the Contract. All costs associated with the safe operations of both the public and the survey personnel, for the duration of the project, is to be met by the surveyor. No additional payments will be considered for costs associated with safety issues.

4.1 General Requirements

In relation to survey work, attention is drawn to the following Acts, Regulations and Codes:

- ◆ The current Workplace Health and Safety Act, its Regulations or their successors.
- ◆ The current Codes of Practice, "approved" under the Workplace Health and Safety Act or their successors.
- ◆ The current Transport Infrastructure Act 1994, its Regulations or their successors.
- ◆ The current Traffic Act, its Regulations or their successors.
- ◆ The current Workers' Compensation Act, its Regulations or their successors.

Following the commissioning of the project, and prior to the commencement of survey work, the surveyor shall have approved, a Quality Plan for the traffic management of the project. Such approval shall be given by the District Safety Officer. This approval in no way exempts the surveyor from his responsibility in relation to the above legislation.

The project area is defined as that area enclosed by the signage and covers the entire width of the road reserve not just the pavement surface.

No signage is to be left displayed when inappropriate, such as lunch breaks and outside normal working hours. At other times, evidence of work in progress must always be visible to the travelling public.

Access to carriageways may be restricted during times of heavy public use. The surveyor is to ensure that all work is carried out in accordance with these restrictions. Advice on these operating times may be provided by the District officer responsible for such advice.

Personnel engaged in work within the project area are to wear the necessary personal safety equipment, at all times.

Where the brief required information to be collected within a Railway Reserve, or land under the control of Queensland Rail, personnel involved in the collection of the information must have completed the Queensland Rail Safety Induction Course, prior to entry upon the land. Evidence of the course completion must be carried by the survey personnel at all times.

Prior to entry onto land under the control of Queensland Rail, the surveyor must advise Queensland Rail and conform to any requirements they may have regarding working conditions, times of operation and safety issues.

Any object placed in the project area should be within the boundary of the signage and if left un-attended, for any period, additionally identified by the use of "witches hats".

Sharp pointed objects, such as pickets, should not be placed on footpaths or in any other pedestrian area.

In order to reduce conflict with pedestrians, survey marks, either instrument stations or recoveries, should be driven "flush" or below the surface.

Personnel using power assisted equipment must have been instructed in, certified to use, or being immediately directed in the safe use of such equipment.

4.2 Roadworks Signing

The "peak" document in the State of Queensland for the placement of signage on the road reserve is the Manual of Uniform Traffic Control Devices Queensland (MUTCD). Copies of the Manual can be obtained from the Main Roads Department.

4.3 Use of Traffic Control

Where the presence of the survey party is sufficient to seriously impede or endanger the public or endanger the survey personnel themselves, arrangements should be made with the Department for the employment of traffic control personnel. In all cases where people, other than Police Officers, are to be used for traffic control, then the surveyor is to ensure that the person having the traffic control responsibility has been certified by the Transport Department as a "Certified Traffic Controller" as required under the Transport Infrastructure Act, 1994.

4.4 Regulatory Signs - Temporary

Despite the use of adequate warning signs and personal safety equipment, survey personnel may be at risk due to the time taken for the motorist to implement preventative action. This situation may exist in rural areas with open speed limits and poor visibility.

In such circumstances, the surveyor may make application to the District Director to install temporary speed restriction signs, for the duration of the project. Such application must be made on Form F994. If approval is granted, the surveyor must maintain details of the location, relocation and times of erection and removal of the regulatory signs, for the duration of the project.

4.5 Unsafe Situations

Should an on-site work situation occur or an on-site work procedure be adopted, either of which, in the judgement of the District Safety Officer, constitutes an unsafe situation, the surveyor shall, upon being advised of it, take immediate action to rectify the situation. If the situation continues un-resolved, the District Safety Officer shall terminate the Contract.

Part F

Disciplinary Procedures

F1

Complaints Procedure

How a complaint can arise

and

How it may be lodged

Investigation and Finalisation

Avenues of gathering
information on a complaint

and

How a complaint may be
finalised



Index

Part F1

Item	Section	Page
Complaint Receipt		
Board Philosophy in Dealing with a Complaint.....	1.0	3
Introduction.....	2.0	3
Background.....	3.0	4
Assessment of Complaint.....	4.0	5
Complaints Committee.....	5.0	5
Terms of Reference.....	5.1	5
Complaint.....	6.0	6
Detail.....	6.1	6
Sources.....	6.2	6
Surveyor against Surveyor.....	6.3	6
Administration.....	7.0	7
Role of Board.....	8.0	8
Vexatious Complaint.....	8.1	8
Arbitration.....	8.2	8

Investigation

Investigations.....	9.0	9
Investigation where Civil Action is possible.....	10.0	9
Notification of Investigation.....	11.0	9

Finalisation

Courses of Action.....	12.0	10
No Breach.....	12.1	10
Minor Breach.....	12.2	10
Substantial Breach.....	12.3	10
Penalties.....	13.0	11
Appeals.....	14.0	11
Publication of Outcome.....	15.0	11

Complaints

1.0 Philosophy in Dealing with a Complaint

A person is registered with the Board, in order to safeguard the public interest.

The Board for a number of years now, has approached its duties in relation to complaint resolution, along the lines that the public interest must be protected and not disadvantaged. Where there is an error in the survey, it must be corrected and the registered person should be appropriately re-educated and/or retrained.

Judge Morley in a Surveyors Disciplinary Committee hearing in August, 1991 said of the Surveyors Act 1977, "the Committee's powers are not punitive powers but are powers which are protective of both the standards of the surveyors' profession and of the public interest in the maintenance of those standards".

Within the context of the Act, both the expression "disciplinary action: in S54(c) and the powers defined by S61 as those able to be exerted by that "action" are parts of a law having a special application to the relationships between any given registered surveyor, his or her professional colleagues, those who seek the professional services of a surveyor or may do so, and that part of the public interest upon which the rendering of those professionals services will or may have an impact.

Many investigations are able to be concluded through discussion and co-operation, as the registered person is able to provide appropriate answers or rectify the matter of concern. To this end, the Board considers that registered persons should assist the Board in the conduct of an investigation. The person against whom a complaint is laid is considered innocent and the Board's charter is to gather all the facts pertaining to a complaint. Co-operation from all parties who may have relevant information to a complaint, is essential in determining an appropriate outcome.

2.0 Introduction

The *Surveyors Act 1977* [Section 17(f)] provides for the Board to receive and investigate reports and complaints concerning the competence of surveyors, surveying graduates and surveying associates and the accuracy of their work.

Part V (Section 53A to 65] of the Act provides for the investigation of complaints and discipline of registered persons.

The Board registers persons at various levels of competence, under the requirements of the *Surveyors Act 1977*. A person is registered as an indicator to the public, that those persons have achieved a level of competence in surveying, that they carry out their work by a code of conduct, are professional in their business dealings and will at all times behave in an ethical manner.

It is the responsibility of the registered person to abide by the requirements on which their registration is granted. Where an apparent mischief/problem has occurred, it must be corrected. Preferably, the registered person will volunteer any corrective process and bring it to a conclusion, in a timely manner, and to the satisfaction of the client, the community interest and the Board.

Mistakes do and will occur. The hallmark of a professional person is to admit to the mistake when it is identified, and to ensure its rectification. Once the matter is satisfactorily resolved, the Board would assist the registered person with appropriate retraining and/or re-education.

Registered persons in the first instance would be expected to resolve matters between themselves. Where resolution is not possible, due to the nature of the disagreement, the Board require the person lodging the complaint to ensure a thorough report is lodge - including plans, sketches and photographs, detailing the facts.

The Mission of the Board is "To ensure public confidence in surveying.". The *Surveyors Act 1977* requires the registered person to maintain competence and act in a professional manner. Registered persons have a responsibility to their clients, the community, and the profession and must abide by the Statutes and the normally accepted survey practices.

3.0 Background

The Complaints Committee of the Surveyors Board of Queensland was initially formed in November 1989.

Prior to the 1990 amendments to the Act, formal disciplinary proceedings against a registered person required prosecution through a "Surveyors Disciplinary Committee", comprising a District Court Judge and two Registered Surveyors.

The 1990 amendments to the Surveyors Act (Sections 65A, 65B and 65C) provides the Board with a "Second Tier" disciplinary procedure, where in the opinion of the Board, the degree of misconduct does not warrant an appearance before the Surveyors Disciplinary Committee. The Board prepares misconduct particulars (charges), but advises the Surveyor being 'charged' that it intends to deal with the misconduct under the "Second Tier".

If the Surveyor accepts the "Second Tier", the Boards decision is final, but the degree of punishment is far less than that available to a Surveyors Disciplinary Committee. The Board would either issue a reprimand and/or a fine and/or a payment of the Boards investigative, legal, hearing and administrative costs.

The remedies available to the Surveyors Disciplinary Committee are those set out above, plus either the suspension or cancellation of endorsements and/or registration.

4.0 Assessment of Complaint

On receipt of a written complaint, the Complaints Committee determines whether or not a complaint made to the Board is frivolous or vexatious. Hence, all complaints require some degree of investigation. Under Section 53B of the Act, the Board may appoint a surveyor to carry out an investigation on behalf of the Board.

All surveyors should be aware of the cost to the Profession in carrying out an investigation. For example, a complaint which does not result in any disciplinary action, yet requires some degree of investigation, could cost from \$3,000 to \$5,000 to process.

Many complaints can be avoided. In particular Surveyor to Surveyor complaints. The parties to a dispute should attempt to resolve the matter in question in the first instance, and as a last resort lodge a formal complaint with the Board.

5.0 Complaints Committee - Terms of Reference

Terms of reference of the Committee were endorsed at the June 1998 Board Meeting.

5.1 Terms of Reference

- Make an initial assessment of each complaint and recommend an appropriate course of action to the Board.
- Seek appropriate advice on the complaint and associated matters and take action to bring the matter of the complaint to a conclusion in a timely manner.
- To encourage participants to a complaint to use conciliation in the first instance to resolve the complaint.
- Endeavour, where possible, to use the involvement of the professional bodies in the resolution process, in conjunction with the Board.
- Where an investigator is to be appointed, brief that investigator in all aspects of their task.
- Review and consider the investigators report and make recommendation thereon to the Board.
- Provide a report to the Board on all aspects of the complaint and recommend on how the matter is to be finalised including appropriate action in cases where an offence has been committed.

6.0 Source and Detail of a Complaint

A complaint of any kind must be in writing and addressed to the Board.

6.1 Detail

Complainants are to provide sufficient detail in support of a complaint and where available, plans and associated documentation. This will assist the Board in determining whether the complaint is within its jurisdiction.

6.2 Sources

A complaint could be sourced from a:-

- (a) Member of the public;
- (b) Fellow surveyor;
- (c) Registering authority; and
- (d) The Board itself.

6.3 Complaint by a Surveyor Against a Surveyor

Guidelines have been prepared for surveyors lodging a complaint about a fellow surveyor.

The complainant is requested to, where appropriate:

- Prior to lodging the complaint, meet with the registered person, or representatives of the registered entity, where this is appropriate, who is the subject of the complaint and conduct meaningful discussions with a view to resolving the matter in the best interests of the profession and the parties concerned.
- Involve where appropriate, office bearers of the ISA Town Group at the location, if this may assist in resolving a surveyor to surveyor disagreement.
- Provide the following information to the Board in the event that the matter cannot be resolved by discussion:-
 - The complainant's name, address, telephone and facsimile numbers, qualifications and experience, occupation and place of employment.
 - The name of the registered person or entity who is the subject of the complaint and state their address, telephone and facsimile numbers, qualifications, occupation and place of employment if known.
 - Provide substantive information in relation to contact with the other registered person.

- A brief succinct and factual statement of the complaint.
- A background history to the complaint and an outline of the steps that have been taken so far in order to resolve the matter. Full details to substantiate the complaint.
- A statement of any deemed non-compliance with the Surveyors Act and Regulation, setting out the appropriate Sections which may apply and the grounds relied upon by the complainant.
- Details of any previous complaint lodged by the complainant.
- A supporting statement from any person who is able to substantiate the validity of the complaint, where this is appropriate.
- Copies of all relevant reports and plans and any other evidence which relates to the complaint.

7.0 Administration

Where an enquiry or verbal complaint is received at the Board's office from any source, Board staff would request the party to commit the matter in writing.

Upon the receipt of a written complaint the Staff:

- acknowledge receipt of the complaint; and
- refer the complaint to the next meeting of the Complaints Committee.

The Board reviews the material and places a categorisation on the complaint based on the information available to it. It endeavours to establish whether a complaint is frivolous, vexatious or has substance.

Further, it attempts to determine the type of allegation, whether it relates to Negligence and/or Incompetence and/or Unprofessional conduct and/or Breach of Contract and/or a vexatious allegation or simply a notification of an event that has occurred or some appropriate allegation in terms of the Act.

The Committee then assesses the degree of mischief associated with the matter, the likely impact on third parties and/or the public interest.

An appropriate course of action is then determined. This may be:

- able to be resolved by a discussion/meeting,
- seek further information from the
 - complainant
 - accused,
- appoint an investigator and determine the type of investigation, eg. field, interview or both,
- other action.

8.0 Board's Disciplinary and Arbitration Role

Allegations of an error, a misunderstanding between parties or a breach of contract will not necessarily constitute grounds for a complaint under the Act. Grounds may exist for matters to be rectified and for aggrieved parties to be compensated, but these are not necessarily for the Board to determine or to be involved in. If the registered person's conduct following these events is allegedly unsatisfactory, the Board then has a duty to consider that conduct.

8.1 Vexatious Complaint

The Board takes care to identify matters of a vexatious or mischievous nature, and that appropriate action is taken on these. The reason for a complaint being lodged would be sought. If negligence, incompetence or misconduct are not alleged, what grounds could one surveyor have for complaining about another, especially if the complainant has not contacted that surveyor in an effort to have the matter rectified?

8.2 Arbitration

Arbitration probably only applies to complaints by surveyors against surveyors or by the Registering Authority against a surveyor. The Board would generally not involve itself in disputes between members of the public and surveyors and where litigation is possible.

Where surveyors are in dispute over matters other than of a technical nature, the Board considers that surveyors should consider seeking assistance from an arbitrator.

Investigation

9.0 Investigations

The Board, having determined the type of and potential seriousness of a complaint, would establish a course of action to deal with the matter. In respect of matters of negligence, dishonesty, incompetence and/or unprofessional conduct, the Board has a duty under the Act to deal with those complaints.

There is however no requirement for the Board to proceed in matters of breach of contract, a vexatious or mischievous allegation, matters of misunderstanding and procedures which may involve claims against professional indemnity insurance. Having said this, the Board is not precluded from dealing with these matters.

After considering the nature of the complaint, the Board may determine that it requires further information or evidence. This may then be gathered in a number of ways as set out earlier. Where an investigator is appointed under Section 53B, the powers of the investigator are set out in Sections 53C, 53D and 53E of the Act.

10.0 Investigation and Disciplinary Action where Civil Action is Possible

The Board has a duty to administer the Act and it would not be deterred because civil proceedings may take place in another jurisdiction. If a complainant (plaintiff) requests that the Board await the outcome of other actions, legal advice would normally be sought.

Where a civil action or insurance claim is pending, the complaint matter would be placed on hold until such time as the civil action is concluded.

The Board would then proceed in the normal manner with an investigation and the assessment of evidence and type of action to be taken.

11.0 Notification of Investigation

The Board, when appointing an investigator, would determine how the person under investigation is to be advised. The following is taken into consideration:-

- Courtesy to the registered person being investigated.
- Appropriate timing to ensure that the investigating surveyor's role is facilitated.

- Where it is established that a field investigation is not required, the registered person would be advised of the investigators appointment by the Board, at the same time that the Board appoints the investigator.
- Where the Board determines in its preliminary assessment of the file that field evidence should be obtained, or where it requests the investigator to confirm that he may need to obtain field data, then the investigator would advise the registered person of the investigation in a timely manner, but no later than when the field investigation is commenced.

Finalisation

12.0 Courses of Action on an Investigators Report

The Board has a number of courses of action available to it on receipt of an investigators report. (Those complaints not requiring an outside investigator will have been dealt with and finalised). These courses are:

- 12.1** Report indicates no breach of the Act and/or Regulation and this is confirmed by the Board.

Brief written response to complainant and defendant. Board file closed.

- 12.2** Report indicates a minor breach of the Act and/or Regulation. The Board confirms this and it may proceed in two ways:-

12.2.1 Minor breach, which the registered person under investigation has acknowledged to the investigator. On the basis of the report, the Board resolves to note the surveyors file and advises the person of the action.

12.2.2 Minor breach, which may or may not be acknowledged by the surveyor. The Registered person is required to appear before the Board. After his/her appearance, the Board resolves its action on the matter, and advises the Registered person of this at his/her appearance and confirms this in writing.

- 12.3** Report indicates a breach or breaches which are either of concern or of a serious nature. The Board confirms this. The breaches warrant the drawing up of misconduct particulars (charges). The misconduct particulars may be dealt with by the Board under Section 65A or the Surveyors Disciplinary Committee under Section 53.

The gravity of the offence would determine whether the registered person is offered the option of coming before the Board or whether the matter should proceed to the Surveyors Disciplinary Committee.

- 12.3.1** Where the Board elects to proceed via Section 65A (2nd tier), the provisions of Section 65B would be implemented.

The person under investigation is advised of the charges, and is given the option of having the misconduct particulars (charges) dealt with by the Board. If this offer is not accepted, then the charges must be dealt with by the Surveyors Disciplinary Committee.

The plaintiff can answer the misconduct particulars in writing and may also appear before the Board. Questioning of the person would usually be limited to seeking clarification on the matters set out in the misconduct particulars.

- 12.3.2** Where the breaches are of a serious nature, or the plaintiff elects not to appear before the Board, the misconduct particulars become formal charges and are dealt with by the Surveyors Disciplinary Committee.

The Surveyors Disciplinary Committee is comprised of a Judge of the District Court and two appropriately qualified Registered Surveyors.

13.0 Penalties

The Board may take disciplinary action where misconduct particulars are found proven by imposing a fine, admonish or reprimand the person or adjourn the matter. The Board can also order a person charged with misconduct, to pay to the Board costs associated with the investigation, for its legal advice and the hearing and administration of an action.

The Surveyors Disciplinary Committee has wide powers under Section 61 and where it finds a charge proven, it may do one or more of the following, reprimand, fine, correct defective work, order payment for the cost of correcting work, restrict the persons' practice to a particular category of surveying for a period of time, suspend the persons' registration, cancel the registration and/or endorsement of the person, and make orders as to costs, including investigation, legal, administrative and hearing costs.

14.0 Appeals

A person may appeal against a decision of a Surveyors Disciplinary Committee on a point of law, (Section 65(2)).

There is no mechanism for appeal under Section 65A.

15.0 Publication by the Board

Decisions of a Surveyors Disciplinary Committee (Section 61) where the decision includes an action which amends the registration of a registered person, are to be published in the Government Gazette. All other decisions of a Surveyors Disciplinary Committee shall be published in the Board's Annual Report and may be published in such publications which are distributed to surveyors.

Decisions of the Board, under a Section 65A hearing, and where the misconduct particulars are upheld (found proven) shall be published in the Board's Annual Report and may be published in such publications which are distributed to surveyors.



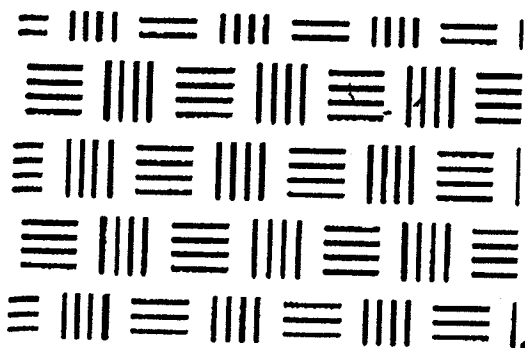

Part G

Surveyors Board Forms

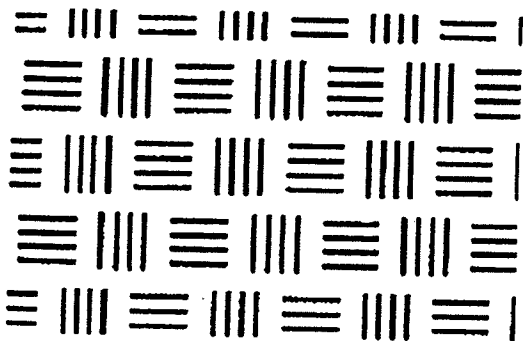

**Specimen copies of all forms
used by the Surveyors Board
and approved by the Board
under the Surveyors
Regulation 1992**

**Persons requiring forms
should contact the Board's
office for originals**

Forms

The Forms set out in this Part, being Nos 1 to 19, shall be used for the purposes for which they are respectively applicable.

A Form as approved by the Board shall be completed in full or as so stated on the Form.

The Board, under the Surveyors Regulations 1992, Section 3, has duly considered the format of the attached Forms Nos 1 to 19 and adopted the use of such forms.

The implementation date for the Forms is as notated on each Form and the Index.

Note:

**The Board Forms included in this Manual are Specimen Copies Only.
Persons requiring forms should contact the Board's office**

Index Part G

Form 1	Effective Date From
Application for Registration as a Surveying Associate	September, 1995
 Form 2	
Application for Registration as a Surveying Graduate	September, 1995
 Form 3	
Application for Registration as a Surveyor	September, 1995
 Form 4	
Application for Endorsement to Perform Cadastral Surveys.....	September, 1995
 Form 5	
Application for Endorsement as a Consulting Surveyor	September, 1995
 Form 6	
Report of Practical Experience.....	September, 1995

Form 7**Effective Date
From**

Application for Acceptance of Projects..... September, 1995

Form 8Application for Approval of a Proposed Professional
Assessment Project..... September, 1995**Form 9A**

Application for Renewal of Registration..... September, 1997

Form 9BApplication for Renewal of Registration as a
Consulting Surveyor..... September, 1997**Form 10**Application for Registration as a Surveyor by a Body
Corporate - Solicitors Certificate..... September, 1995**Form 11**Application for Renewal of Registration as a Surveyor by a
Body Corporate - Directors' Certificate..... September, 1995**Form 12**

Certificate for Survey Records..... September, 1995

Form 13

Certificate for Cadastral Plans..... April, 1993

Form 14

Certificate of Registration as a Surveying Associate..... September, 1995

Form 15

Certificate of Registration as a Surveying Graduate..... September, 1995

Form 16Certificate of Registration as a Licensed Surveyor or
Surveyor..... September, 1995

Form 17

**Effective Date
From**

Recertification of Cadastral Plan..... August, 1993

Form 18

Certificate for Cadastral Plans - Compiled August, 1993

Form 19

Certificate of Endorsement..... September, 1995

Form 1
QUEENSLAND

Surveyors Act 1977 (Ss. 38A and 39)
Surveyors Regulation 1992 (Section 6)

APPLICATION FOR REGISTRATION AS A SURVEYING ASSOCIATE

To: The Secretary,
Surveyors Board of Queensland.

I, _____ of
(Full Name)

Residential Address: _____
Postal Address: _____
Date of Birth: _____
Telephone No. (Business) _____ Fax No. _____
Name & Address of Employer: _____

_____ hereby apply
for registration under this Act as a Surveying Associate. In support of my application, I enclose the
following documentary evidence:- +

Checklist

<input type="checkbox"/>	application fees;	<input type="checkbox"/>
<input type="checkbox"/>	copy of diploma or other certificates;	<input type="checkbox"/>
<input type="checkbox"/>	statement of practical experience;	<input type="checkbox"/>
<input type="checkbox"/>	supporting statements from employer/supervisor;	<input type="checkbox"/>
<input type="checkbox"/>	two references to good fame and character (dated within last 12 months);	<input type="checkbox"/>

Date: _____

Signature of Applicant

* Insert residential and postal address, and telephone and facsimile numbers.

+ Copies of diplomas and other relevant certificates, copies of references as to good fame and character, and copies of documents showing particulars of the practical experience relied on by the applicant for the purposes of registration.

September 1995

Office Use Only
FEE:
DATE:
REC NO:

Form 2
QUEENSLAND

Surveyors Act 1977 (Ss. 38 and 39)
Surveyors Regulation 1992 (Section 7)

APPLICATION FOR REGISTRATION AS A SURVEYING GRADUATE

To: The Secretary,
Surveyors Board of Queensland.

I, _____ of
(Full Name)

Date of Birth:

* Residential Address:

Postal Address:

Telephone No. (Business) _____ Fax No _____

Name & Address of Employer:

_____ hereby apply for
registration under this Act as a Surveying Graduate. In support of my application, I enclose the following
documentary evidence:- +

Checklist

- | | | |
|--------------------------|---|--------------------------|
| <input type="checkbox"/> | application fees; | <input type="checkbox"/> |
| <input type="checkbox"/> | copy of degree or other certificates ; | <input type="checkbox"/> |
| <input type="checkbox"/> | two recent references to good fame and character (dated within last 12 months); | <input type="checkbox"/> |

Date: _____

Signature of Applicant

* Insert residential and postal address, and telephone and facsimile numbers.

+ Copies of degrees, diplomas and other relevant certificates, and copies of references as to good fame and character.

September 1995

<i>Office Use Only</i>
FEE:
DATE:
REC NO:

Form 3
QUEENSLAND

Surveyors Act 1977 (Ss. 37, 39 and 40)
Surveyors Regulation 1992 (Section 8 and 11)

APPLICATION FOR REGISTRATION AS A SURVEYOR

To: The Secretary,
Surveyors Board of Queensland.

I, _____ of
(Full Name)

Date of Birth: _____

* Residential Address: _____

Telephone No. (Business) _____ Postal Address: _____
Name & Address of Employer: _____ Fax No. _____

hereby apply for registration under this Act as a Surveyor. In support of my application, I enclose the following documentary evidence: +

Checklist

- application fees;
- copy of degree or other certificates;
- two recent references to good fame and character (within last 12 months);

Date: _____

Signature of Applicant

* Insert residential and postal address or, in the case of a body corporate, the address of its registered office and postal address, and telephone and facsimile numbers.

+ Copies of degrees, diplomas and other relevant certificates, and copies of references as to good fame and character in the case of a natural person or, in the case of a body corporate, copies of the documentary evidence required to comply with Section 11 of the Surveyors Regulation 1992.

To be signed by the applicant in the case of an individual or, in the case of a body corporate, by a director who is a Registered Surveyor.

September 1995

Office Use Only

FEE: _____

DATE: _____

REC NO: _____

Form 4
QUEENSLAND

Surveyors Act 1977 (Ss. 40 and 42)
Surveyors Regulation 1992 (Section 9 and 14)

APPLICATION FOR ENDORSEMENT TO PERFORM CADASTRAL SURVEYS

To: The Secretary,
Surveyors Board of Queensland.

I, _____ of
(Full Name)

Date of Birth: _____ *

Residential Address:

Postal Address:

Telephone No. (Business) _____ Fax No.

Name & Address of Employer:

hereby apply to have my registration in the Register of Surveyors endorsed to the effect that I may perform cadastral surveys. In support of my application, I enclose the following documentary evidence: +

Checklist

- | | | |
|--------------------------|---|--------------------------|
| <input type="checkbox"/> | application fees; | <input type="checkbox"/> |
| <input type="checkbox"/> | copy of degree or other certificates; | <input type="checkbox"/> |
| <input type="checkbox"/> | two recent references to good fame and character (dated within the last 12 months); | <input type="checkbox"/> |

Date: _____

Signature of Applicant

* Insert residential and postal address or, in the case of a body corporate, the address of its registered office and postal address, and telephone and facsimile numbers.

+ Copies of degrees, diplomas and other relevant certificates in the case of a natural person or, in the case of a body corporate, copies of the documentary evidence required to comply with Section 14 of the Surveyors Regulation 1992.

To be signed by the applicant in the case of an individual or, in the case of a body corporate, by a director who is a Licensed Surveyor.

Office Use Only
FEE:
DATE:
REC NO:

September 1995

**Form 5
QUEENSLAND**

Checked By:	
-------------	--

Surveyors Act 1977 (S. 42A)
Surveyors Regulation 1992 (Section 10)

APPLICATION FOR ENDORSEMENT AS A CONSULTING SURVEYOR

To: The Secretary,
Surveyors Board of Queensland.

† I, _____, of
(Full Name)

Date of Birth:

Residential Address:

Postal Address:

Telephone No. (Business) _____ Fax No.

hereby apply to have my registration in the Register of Surveyors endorsed to the effect that I am a Consulting Surveyor. I certify that I provide or intend to provide survey services to the public for a fee. In support of my application, I provide the following information:-

1. Under what name or as a part of what entity do you intend to practise?

2. Are you at present rendering survey services to the public for a fee?

3. Do you have an office out of which you presently consult to the public?

4. If the answer to (3) is yes, what is the address?

5. If the answer to (3) is no, do you intend to establish an office and if so at what address?

6. Section 10(2) of the Surveyors Regulation 1992 requires that applicants take out and maintain Professional indemnity Insurance. Please advise the following details:-

- (a) The name of the Insurance Company
- (b) Your policy number
- (c) The amount insured (min \$250,000)

A copy of the insurance certificate is to be lodged with this application.

Check List

7. Section 10(2) of the Surveyors Regulation 1992 requires that applicants take out and maintain Public Liability Insurance. Please advise the following details:-

(a) The name of the Insurance Company _____

(b) Your policy number

(c) The amount insured (min \$2,000,000)

A copy of the insurance certificate is to be lodged with this application.

8. Do you have or are you in the process of implementing a Quality Assurance program?

9. Do you take part in Continuing Professional Development (CPD) programs and if so to what extent?

10. Please provide the Board with the following information by attaching same to this application form -

(a) a copy of the letterhead under which you practise;

(b) a copy of the form of invoice on which you bill clients;

(e) application fees.

11. Bodies Corporate, please also provide the Board with the following and attach same to this application form -

(a) completed Form 10;

(b) list of all employees, their qualifications and registered status.

Date: _____

Signature of Applicant

‡ Body Corporate MUST include ACN.

* Insert residential and postal address or in the case of a body corporate, the address of its registered office and post address, and telephone and facsimile numbers.

To be signed by the applicant in the case of an individual, or, in the case of a Body Corporate, by a Director who is a Registered Surveyor.

Office Use Only
FEE:
DATE:
REC NO:

September 1995

Form 6
 QUEENSLAND
 Surveyors Act 1977 (S. 37)
 REPORT OF PRACTICAL EXPERIENCE

To: The Secretary, Surveyors Board of Queensland.

I, _____
 (Full Name)

of _____

Postal Address: _____

a Licensed Surveyor/Surveyor registered under this Act, certify that _____ a Surveying Graduate has gained practical experience in surveys under my direction and supervision for a period of _____ weeks.

He/she has performed the following work as specified:-

REPORTING PERIOD: _____

TO: _____

+ Type Of Survey	Description Of Work	Minimum Required For Surveyor Registration	Number of Weeks
<i>Cadastral (Urban)</i>		6 months	
<i>Cadastral (Rural)</i>		6 months	
<i>Engineering Survey & Design</i>		6 months	
<i>Topographic</i>		Plus 6 months in another field of surveying.	
<i>Geodetic/Astronomy</i>			
<i>Design (Urban &/or Rural)</i>			
<i>Other (Please Specify)</i>			

His/Her performance was as follows:-*

Date: _____

 Signature of Licensed Surveyor/Surveyor

* report should state clearly the level of performance achieved by the Surveying graduate/student in all aspects (ethical, administrative and technical) of the practice of surveying.

September, 1995

Form 7
QUEENSLAND
Surveyors Act 1977 (S. 37)

APPLICATION FOR ACCEPTANCE OF PROJECTS

To: The Secretary
Surveyors Board of Queensland.

PART A

I hereby certify that + _____
has completed the projects listed hereunder, which are equivalent to those prescribed by the Surveyors Board of Queensland, and that the projects have been performed at an appropriate level of responsibility. I recommend that such projects be accepted by the Board.

*List of projects:-

Date: _____

Signature of Head of Surveying School,
(Name of Education Institution)

PART B

I + _____ of
(Full Name)

Residential Address:

Postal Address:

Telephone No. (Business) _____ Fax No.

hereby certify that all field and office observations and notes, computations, plans and reports in relation to the projects listed hereunder were made by me personally with such assistance as was necessary in each operation and that the projects were not copied.

* List of projects:-

Date: _____

Signature of Surveying Graduate/Student

* Describe each project and state its date of commencement and date of completion.
If the space is insufficient, attach a schedule.

+ Insert full name of surveying graduate/student.

September 1995

<i>Office Use Only</i>
FEE:
DATE:
REC NO:

Form 8
QUEENSLAND

Surveyors Act 1977 (S. 37)

APPLICATION FOR APPROVAL OF A PROPOSED PROFESSIONAL
ASSESSMENT PROJECT

To: The Secretary,
Surveyors Board of Queensland.

I, _____, of
(Full Name)

* Residential Address:

Postal Address:

Telephone No. (Business) _____ Fax No.

Nomination of Assistant Examiner:

Name & Address of Employer:

A Surveying Graduate hereby apply for approval of a proposed Professional Assessment Project.

Nature of project proposed:-

Details of the project are attached.

Date: _____

Signature of Applicant

* Insert residential and postal address and telephone and facsimile numbers.

<i>Office Use Only</i>
FEE:
DATE:
REC NO:

September 1995

Form 9A
QUEENSLAND
Surveyors Act 1977 (Ss. 40, 41 and 42)

APPLICATION FOR RENEWAL OF REGISTRATION AS A
SURVEYOR, LICENSED SURVEYOR,
SURVEYING GRADUATE OR SURVEYING ASSOCIATE

To: The Secretary
Surveyors Board of Queensland

I, _____ of
(Full Christian and Surname's)

Residential address: _____

Postal address _____

§ Employer: _____

Telephone No: (Business) _____ Fax No: _____

hereby apply for renewal of my registration under this Act as a +

<input type="checkbox"/> Surveying Associate	#	<input type="checkbox"/> Surveying Graduate	#
" Completed Form 9A	<input type="checkbox"/>	" Completed Form 9A	<input type="checkbox"/>
" Full renewal fees	<input type="checkbox"/>	" Completed Form 6	<input type="checkbox"/>
		" Full renewal fees	<input type="checkbox"/>
<input type="checkbox"/> Surveyor	#	<input type="checkbox"/> Emeritus Certificate (Retired)	
Surveyor #	<input type="checkbox"/>	" Completed Form 9A	<input type="checkbox"/>
" Completed Form 9A	<input type="checkbox"/>	" Proof of age	<input type="checkbox"/>
" Full renewal fees	<input type="checkbox"/>	" Signed statement	<input type="checkbox"/>
		" Full 'Emeritus' fee	<input type="checkbox"/>
<input type="checkbox"/> AND	for endorsement to the effect that I may perform cadastral surveys for the year		
	ending on 31 December, 1998.		
		" Completed Form 9A	<input type="checkbox"/>
		" Full renewal fees	<input type="checkbox"/>

S
U
R
V
E
Y
O
R
S

O
N
L
Y

Date: ___/___/1997

Signature of Applicant

I certify that I maintained my competence during 1997 in the level of registration for which I seek renewal.

Date: ___/___/1997

Signature of Applicant

- * Insert residential and postal address or in the case of a body corporate, the address of its registered office and post address, and telephone and facsimile numbers.
- § Name of Government Dept, Local Council, Body Corporate or Sole Trader.
- + Indicate (✓) category(s) of registration for which renewal is sought.
- # Check boxes provided for applicants to check off that ALL material is attached.

Office Use Only
FEE:
DATE:
REC NO:

September 1997

**Forms 9B
QUEENSLAND**

Surveyors Act 1977 (Ss. 40, 41 and 42)

**APPLICATION FOR RENEWAL OF REGISTRATION AS A
CONSULTING SURVEYOR**

To: The Secretary, Surveyors Board of Queensland.

† I, _____ of
(Full Christian and Surname's)

* Residential Address:

Postal Address:

§ Employer:

Telephone No: (Business) _____ Fax No: _____

hereby apply for renewal of my registration as a surveyor under this Act and for the following endorsements:- +

- 1. to the effect that I may perform cadastral surveys
- 2. to the effect that I am a consulting surveyor

Check
List

The following information is provided in support of my application:

1. Under what name or as a part of what entity do you intend to practise?

2. Are you at present rendering survey services to the public for a fee?

3. Do you have an office out of which you presently consult to the public?

4. If the answer to (3) is yes, what is the address?

5. If the answer to (3) is no, do you intend to establish an office and if so at what address?

6. Section 10(2) of the Surveyors Regulation 1992 requires that applicants take out and maintain Professional indemnity Insurance. Please advise the following details:-
 - (a) The name of the Insurance Company
 - (b) Your policy number
 - (c) The amount insured (min \$250,000)

A copy of the annual renewal certificate showing the amount insured and the term of currency of the policy is to be enclosed with this application.

7. Section 10(2) of the Surveyors Regulation 1992 requires that applicants take out and maintain Public Liability Insurance. Please advise the following details:-

- (a) The name of the Insurance Company
- (b) Your policy number
- (c) The amount insured (min \$2,000,000)

A copy of the annual renewal certificate showing the amount insured is to be lodged with this application.

8. Do you have or are you in the process of implementing a Quality Assurance program?

9. Do you take part in Continuing Professional Development (CPD) programs and if so to what extent?

10. Please provide the Board with the following information by attaching same to this application form -

- (a) a copy of the letterhead under which you practise;
- (b) a copy of the form of invoice on which you bill clients;
- (c) full renewal fees.

11. Bodies Corporate, please also provide the Board with the following and attach same to this application form -

- (a) completed Form 11;
- (b) list of all employees, their qualifications and registered status.

Date: _____ # Signature of Applicant _____

FOR NATURAL PERSONS ONLY

12. I certify that I maintained my competence during 1997 in the level of registration for which I seek renewal.

Date: ___/___/199 Signature of Applicant _____

- † Body Corporate MUST include ACN.
- * Insert residential and postal address or in the case of a body corporate, the address of its registered office and post address, and telephone and facsimile numbers.
- § To be completed by the Individual - name of Government Dept, Local Council, Body Corporate or Sole Trader.
- # To be signed by the applicant in the case of an individual or, in the case of a body corporate, by a director who is a Registered Surveyor
- + Indicate (✓) category(s) of endorsement for which renewal is sought.

Office Use Only

FEE:

DATE:

REC NO:

Form 10
QUEENSLAND

Surveyors Act 1977 (Section 40)
Surveyors Regulation 1992 (Section 12)

APPLICATION FOR REGISTRATION AS A SURVEYOR BY A BODY
CORPORATE

SOLICITORS CERTIFICATE

To: The Secretary,
Surveyors Board of Queensland

I _____ Solicitor,
of _____

_____ hereby certify that the Memorandum and Articles of
Association of the Body Corporate _____ Pty Ltd
incorporated in the State of Queensland on _____ complies
with the following sections of Surveyors Regulation 1992.

Surveyors Regulation 1992

Section 11(c)(i)

- " 11(c)(ii)
- " 11(c)(iii)
- " 11(c)(iv)
- " 11(c)(v)
- " 11(c)(vi)
- " 14(2)(b)

Date: _____

Signature

* Section 14(2)(b) should be deleted if not applicable.

September 1995

Form 11
QUEENSLAND

Surveyors Act 1977 (Section 40)
Surveyors Regulation 1992 (Section 13)

APPLICATION FOR RENEWAL OF REGISTRATION AS A SURVEYOR BY A
BODY CORPORATE

DIRECTORS' CERTIFICATE

To: Secretary,
Surveyors Board of Queensland

We _____, the Directors

hereby certify that the Memorandum and Articles of Association of the Body Corporate

_____ Pty Ltd

comply with the following sections of Surveyors Regulation 1992.

Surveyors Regulation 1992

Section 11(c)(i)

- " 11(c)(ii)
- " 11(c)(iii)
- " 11(c)(iv)
- " 11(c)(v)
- " 11(c)(vi)
- " 14(2)(b)

Date: _____

(All the Directors to sign)

* Section 14(2)(b) should be deleted if not applicable.

September, 1995

Form 12
QUEENSLAND

Surveyors Act 1977
Surveyors Regulation 1992 (S 33)

CERTIFICATE FOR SURVEY RECORDS

I * _____ hereby certify that the survey records +
_____ are accurate records of the survey performed by myself
personally/the company or by # _____ for those work I/the company
accept responsibility.

* Signature of Licensed Surveyor

Date: _____

- * Insert full name of Licensed Surveyor or, as the case may be, the name of the company.
- + Insert sufficient particulars to properly identify the surveys records being certified.
- # Insert full name of the person and his qualifications + .
- * Or, in the case of a company, execution under the Common Seal in the manner referred to in Section 11 of the Surveyors Regulation 1992.

May, 1992

Form 13
QUEENSLAND

Surveyors Act 1977
Surveyors Regulation 1992 (Section 30)

CERTIFICATE FOR CADASTRAL PLANS

1. _____ hereby certify that 2 _____ surveyed the land
comprised in this plan 3 _____ for whose work *
4. _____ and that the plan is accurate, that the said survey
was performed in accordance with the Surveyors Act 1977 and the Surveyors Regulation 1992, and
that the said survey was completed on 5 _____

6. _____
Licensed Surveyor (Sign) Director & Licensed Surveyor (Sign)
Date: _____
Director (Sign)

- 1. - I, (full name of Licensed Surveyor or Name of Company endorsed as Licensed Surveyor)
 - 2. - I have, or the company has
 - 3. - personally (leave 4 blank), or
- by (full name and qualification of licensed surveyor),
and if applicable
- and by (full name and qualification of registered person),
 - 4. - I accept responsibility, or
- the Company accepts responsibility
 - 5. - Date
 - 6. - Signature
 - 7. - Company must execute under Common Seal, see Regulation 11(e) (vi)
- * Delete if applicable.

April 1993

Form 14

Reg No. _____

Certificate of Registration as a Surveying Associate

This is to Certify that

was registered under this Act as a

Surveying Associate

on the _____ of _____, 19____.

Registration under this Act remains in force subject to
renewal from year to year and otherwise subject to the
provisions of this Act.

Sealed with the Common Seal of the Board, this

_____ of _____, 19____.

.....
President

.....
Secretary

Form 15

Reg No. _____

Certificate of Registration as a Surveying Graduate

This is to Certify that

was registered under this Act as a

Surveying Graduate

on the _____ of _____, 19____.

Registration under this Act remains in force subject to
renewal from year to year and otherwise subject to the
provisions of this Act.

Sealed with the Common Seal of the Board, this

_____ of _____, 19____.

Specimen Only

.....
President

.....
Secretary

Form 16

Reg No. _____

Certificate of Registration as a Licensed Surveyor/Surveyor

This is to Certify that

was registered under this Act as a

Surveyor

on the _____ of _____, 19____.

This registration was endorsed on the Eighth day of September, 1995

to the effect that he may perform cadastral surveys.

Registration under this Act remains in force subject to

renewal from year to year and otherwise subject to this Act.

Sealed with the Common Seal of the Board, this

_____ of _____, 19____.

Specimen Only

.....
President

.....
Secretary

Form 17
QUEENSLAND

Surveyors Act 1977 (Section 76)

RECERTIFICATION OF CADASTRAL PLAN

1 _____ hereby certify this plan is accurate at this date of re-certification.

2 _____

Licensed Surveyor (Sign)

2/3 _____
Director & Licensed (Sign)
Surveyor

Date: _____

2/3 _____
Director (Sign)

-
1. - I, (full name of Licensed Surveyor or
- Name of Company endorsed as Licensed Surveyor)
 2. - Signature
 3. - Company must execute under Common Seal, see Regulation 11(c)(vi)

The implementation date of the Form is 1/8/93.

August 1993

Form 18
QUEENSLAND

Surveyors Act 1977
Surveyors Regulation 1992 (Section 25)

CERTIFICATE FOR CADASTRAL PLANS - COMPILED

1 _____ hereby certify that 2 _____ made this plan pursuant to
Section 25 of the Surveyors Regulation 1992 and that the plan is accurate, and compiled
from _____ in the Department of

3 _____

4 _____

Licensed Surveyor (Sign)

4/5 _____
Director & Licensed (Sign)
Surveyor

Date: _____

4/5 _____
Director (Sign)

1. - I, (full name of Licensed Surveyor or
- Name of Company endorsed as Licensed Surveyor)
2. - I have, or
- the Company has, or
- Full name and qualification of registered person has
3. - Department of Lands and/or Minerals & Energy or other source.
4. - Signature
5. - Company must execute under Common Seal, see Regulation 11(c)(vi)

April, 1993

Form 19

Reg No. _____

Certificate of Endorsement as a Consulting Surveyor

This is to Certify that

_____ is registered under this Act as a

Surveyor

This registration was endorsed on the _____ day of _____, 19__

to the effect that he may consult to the public for a fee.

Registration under this Act remains in force subject to
renewal from year to year and otherwise subject to this Act.

Sealed with the Common Seal of the Board, this

_____ day of _____, 19__

Specimen Only

.....
President

.....
Secretary

September, 1995

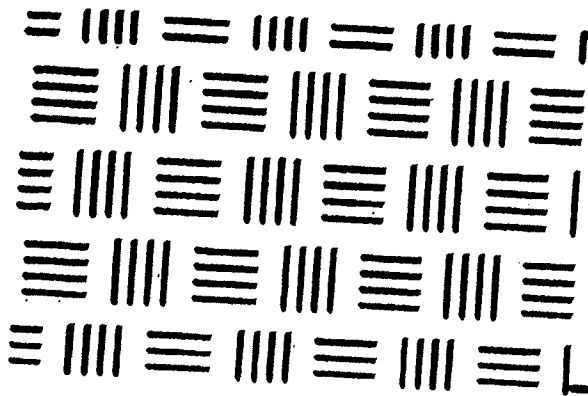

Part

Y

**Surveyors
Act**

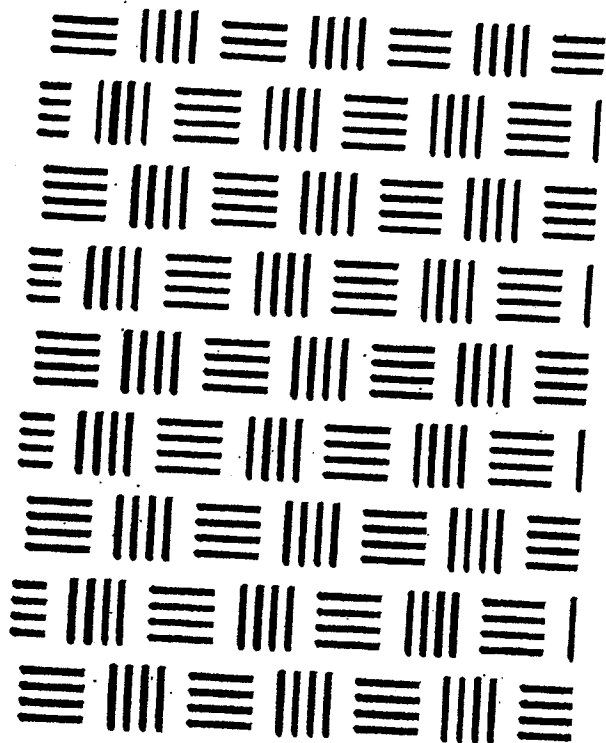

Published by:

Surveyors Board of Queensland
PO Box 810
SPRING HILL QLD 4004

Phone: (07) 3839-7744
Fax: (07) 3839-8341

Surveyors Act

The Surveyors Act 1977 (as amended) is a copyright publication and is available only from the Government Printer — GOPRINT

Manual owners are encouraged to install their copy of the updated Act in this folder to provide a complete record

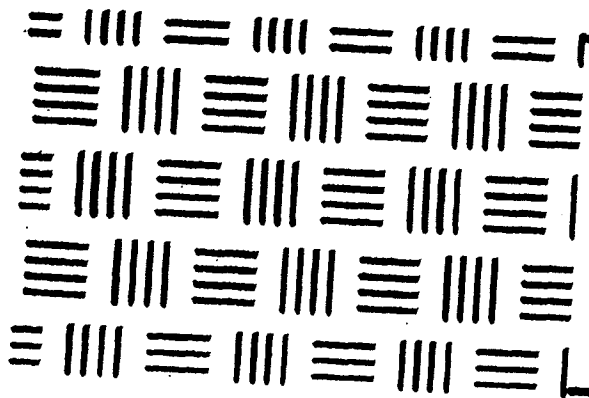

Part

Z

**Surveyors
Regulation**

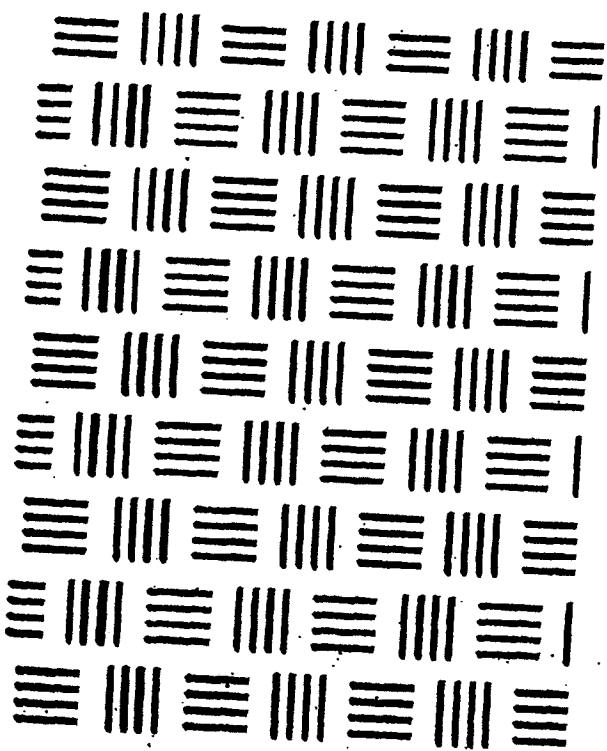

Published by :

Surveyors Board of Queensland
PO Box 810
SPRING HILL QLD 4004

Phone: (07) 3839-7744
Fax: (07) 3839-8341

Surveyors Regulation

**The Surveyors Regulation 1992 is a copyright publication and is available only from the Government Printer
— GOPRINT**

Manual owners are encouraged to install their copy of the Regulation in this folder to provide a complete record

7